

# ALUMINUM ELECTROLYTIC CAPACITORS

# LKG

Lug / Snap-in Terminal Type,  
For Audio Equipment



- Designed for high grade audio equipment, giving priority to high fidelity sound quality.
- The variation expansion of the LKG.
  - TYPE- I : The low profile high tone quality grade of the new development electrolyte adoption.
  - TYPE- II : The center grade that the best sound is provided electrode foil, with the multiple use.
  - TYPE- III : The highest tone quality grade by the low drag the gold plating terminal adoption.
- The sound quality that it meets the high tone quality needs for HD Audio equipment.
- Compliant to the RoHS directive (2011/65/EU,(EU)2015/863).

Super Through  
High Grade  
Gold Tune

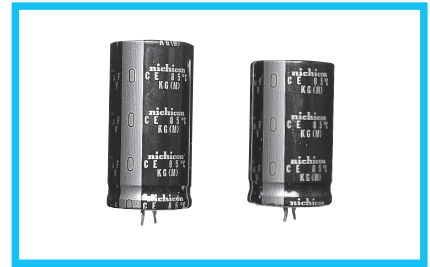

## Specifications

Item	Performance Characteristics									
Category Temperature Range	- 40 to +85°C									
Rated Voltage Range	16 to 100V (TYPE- I , TYPE- II , TYPE-III)									
Rated Capacitance Range	680 to 33000μF									
Capacitance Tolerance	±20% at 120Hz, 20°C									
Leakage Current	After 5 minutes' application of rated voltage at 20°C, leakage current is not more than $3\sqrt{CV}$ (μA), [C: Rated Capacitance(μF), V: Voltage (V)]									
Tangent of loss angle (tan δ)	See refer to next page (Measurement frequency : 120Hz at 20°C)									
Stability at Low Temperature	<table border="1"> <thead> <tr> <th>Rated voltage (V)</th> <th>16 to 100</th> <th>Measurement frequency : 120Hz</th> </tr> </thead> <tbody> <tr> <td>Impedance ratio (max.)</td> <td><math>Z(-25^{\circ}\text{C}) / Z(+20^{\circ}\text{C})</math></td> <td>4</td> </tr> <tr> <td></td> <td><math>Z(-40^{\circ}\text{C}) / Z(+20^{\circ}\text{C})</math></td> <td>12</td> </tr> </tbody> </table>	Rated voltage (V)	16 to 100	Measurement frequency : 120Hz	Impedance ratio (max.)	$Z(-25^{\circ}\text{C}) / Z(+20^{\circ}\text{C})$	4		$Z(-40^{\circ}\text{C}) / Z(+20^{\circ}\text{C})$	12
	Rated voltage (V)	16 to 100	Measurement frequency : 120Hz							
Impedance ratio (max.)	$Z(-25^{\circ}\text{C}) / Z(+20^{\circ}\text{C})$	4								
	$Z(-40^{\circ}\text{C}) / Z(+20^{\circ}\text{C})$	12								
Endurance	<p>The specifications listed at right shall be met when the capacitors are restored to 20°C after the rated voltage is applied for 1000 hours at 85°C.</p> <table border="1"> <tbody> <tr> <td>Capacitance change</td> <td>Within ±20% of the initial capacitance value</td> </tr> <tr> <td>tan δ</td> <td>200% or less than the initial specified value</td> </tr> <tr> <td>Leakage current</td> <td>Less than or equal to the initial specified value</td> </tr> </tbody> </table>	Capacitance change	Within ±20% of the initial capacitance value	tan δ	200% or less than the initial specified value	Leakage current	Less than or equal to the initial specified value			
Capacitance change	Within ±20% of the initial capacitance value									
tan δ	200% or less than the initial specified value									
Leakage current	Less than or equal to the initial specified value									
Shelf Life	After storing the capacitors under no load at 85°C for 1000 hours and then performing voltage treatment based on JIS C 5101-4 clause 4.1 at 20°C, they shall meet the specified values for the endurance characteristics listed above.									
Marking	Printed with gold color letter on black sleeve.									

## Type numbering system (Snap-in terminal type)

(Example : Gold Tune 25 V 6800μF, Dia.φ30)

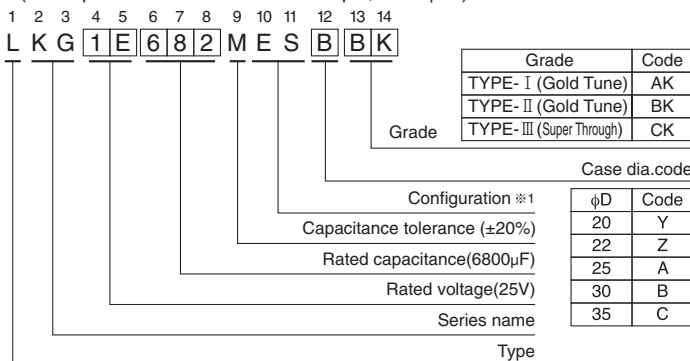

※1 Configuration

Pb-free terminal  
Pb-free PET sleeve  
ES

(Snap-in terminal type)

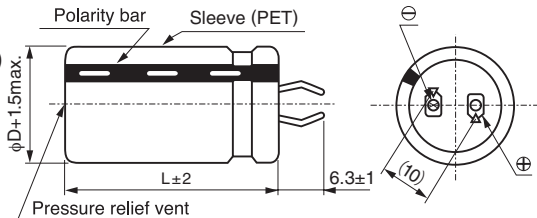

(PC board hole dimensions)

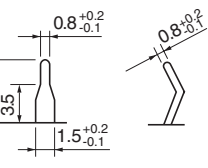
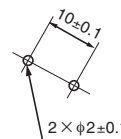

(Terminal dimensions)

(Lug terminal type)

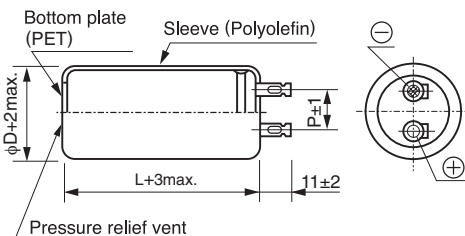

## Configuration ※2

φ35 to φ40 φ50 to φ76

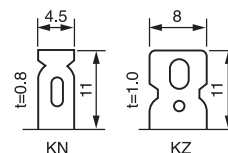

	(mm)				
φD	35	40	50	63	76
P	14	14	18	25	25
Configuration	KN		KZ		

● Dimension table in next page.

## LKG

■ Dimensions (Snap-in Terminal Type : Grade TYPE- I )

16V(1C)				
Cap. (μF)	Size φD × L(mm)	Rated ripple (Arms)	tan δ	Code
4700	22 × 20	1.35	0.35	LKG1C472MESZAK
5600	20 × 25	1.45	0.35	LKG1C562MESYAK
6800	25 × 20	1.70	0.35	LKG1C682MESAAK
8200	20 × 30	1.90	0.35	LKG1C822MESYAK
	22 × 25	1.90	0.35	LKG1C822MESZAK
10000	20 × 35	2.05	0.35	LKG1C103MESYAK
	22 × 30	2.05	0.35	LKG1C103MESZAK
	25 × 25	2.00	0.35	LKG1C103MESAAK
	30 × 20	2.10	0.35	LKG1C103MESBAK
12000	20 × 40	2.25	0.35	LKG1C123MESYAK
	22 × 35	2.20	0.35	LKG1C123MESZAK
	25 × 30	2.15	0.35	LKG1C123MESAAK
	35 × 20	2.10	0.35	LKG1C123MESCAK
15000	20 × 45	2.60	0.35	LKG1C153MESYAK
	22 × 40	2.50	0.35	LKG1C153MESZAK
	25 × 35	2.40	0.35	LKG1C153MESAAK
	30 × 25	2.50	0.35	LKG1C153MESBAK
18000	22 × 45	2.80	0.35	LKG1C183MESZAK
	25 × 40	2.60	0.35	LKG1C183MESAAK
	30 × 30	2.65	0.35	LKG1C183MESBAK
22000	25 × 45	2.95	0.35	LKG1C223MESAAK
	30 × 35	2.90	0.35	LKG1C223MESBAK
	35 × 25	2.90	0.35	LKG1C223MESCAK
27000	25 × 50	3.40	0.45	LKG1C273MESAAK
	30 × 40	3.25	0.45	LKG1C273MESBAK
	35 × 30	3.35	0.45	LKG1C273MESCAK
33000	30 × 45	3.70	0.57	LKG1C333MESBAK
	35 × 35	3.65	0.57	LKG1C333MESCAK

25V(1E)				
Cap. (μF)	Size φD × L(mm)	Rated ripple (Arms)	tan δ	Code
3300	22 × 20	1.50	0.30	LKG1E332MESZAK
3900	20 × 25	1.60	0.30	LKG1E392MESYAK
	25 × 20	1.55	0.30	LKG1E392MESAAK
4700	20 × 30	1.70	0.30	LKG1E472MESYAK
	22 × 25	1.70	0.30	LKG1E472MESZAK
5600	30 × 20	1.85	0.30	LKG1E562MESBAK
6800	20 × 35	2.20	0.30	LKG1E682MESYAK
	22 × 30	2.20	0.30	LKG1E682MESZAK
	25 × 25	2.15	0.30	LKG1E682MESAAK
	20 × 40	2.40	0.30	LKG1E822MESYAK
8200	22 × 35	2.35	0.30	LKG1E822MESZAK
	25 × 30	2.30	0.30	LKG1E822MESAAK
	35 × 20	2.25	0.30	LKG1E822MESCAK
	20 × 50	2.55	0.30	LKG1E103MESYAK
10000	22 × 40	2.65	0.30	LKG1E103MESZAK
	25 × 35	2.50	0.30	LKG1E103MESAAK
	30 × 25	2.65	0.30	LKG1E103MESBAK
	22 × 45	2.90	0.30	LKG1E123MESZAK
12000	25 × 40	2.75	0.30	LKG1E123MESAAK
	30 × 30	2.80	0.30	LKG1E123MESBAK
	35 × 25	2.65	0.30	LKG1E123MESCAK
15000	25 × 45	3.15	0.30	LKG1E153MESAAK
	30 × 35	3.10	0.30	LKG1E153MESBAK
18000	25 × 50	3.55	0.30	LKG1E183MESAAK
	30 × 40	3.40	0.30	LKG1E183MESBAK
	35 × 30	3.50	0.30	LKG1E183MESCAK
22000	30 × 45	3.85	0.30	LKG1E223MESBAK
	35 × 35	3.85	0.30	LKG1E223MESCAK
27000	35 × 40	4.30	0.40	LKG1E273MESCAK
33000	35 × 45	4.85	0.52	LKG1E333MESCAK

35V(1V)				
Cap. (μF)	Size φD × L(mm)	Rated ripple (Arms)	tan δ	Code
2200	22 × 20	1.45	0.30	LKG1V222MESZAK
2700	20 × 25	1.60	0.30	LKG1V272MESYAK
	25 × 20	1.55	0.30	LKG1V272MESAAK
3300	20 × 30	1.75	0.30	LKG1V332MESYAK
	22 × 25	1.75	0.30	LKG1V332MESZAK
3900	30 × 20	1.85	0.30	LKG1V392MESBAK
4700	20 × 35	2.20	0.30	LKG1V472MESYAK
	22 × 30	2.20	0.30	LKG1V472MESZAK
	25 × 25	2.15	0.30	LKG1V472MESAAK
5600	20 × 40	2.40	0.30	LKG1V562MESYAK
	22 × 35	2.35	0.30	LKG1V562MESZAK
	25 × 30	2.25	0.30	LKG1V562MESAAK
	35 × 20	2.25	0.30	LKG1V562MESCAK
6800	20 × 50	2.50	0.30	LKG1V682MESYAK
	22 × 40	2.60	0.30	LKG1V682MESZAK
	30 × 25	2.60	0.30	LKG1V682MESBAK
8200	22 × 45	2.90	0.30	LKG1V822MESZAK
	25 × 40	2.70	0.30	LKG1V822MESAAK
	30 × 30	2.75	0.30	LKG1V822MESBAK
	25 × 45	3.05	0.30	LKG1V103MESAAK
10000	30 × 35	3.00	0.30	LKG1V103MESBAK
	35 × 25	3.20	0.30	LKG1V103MESCAK
	25 × 50	3.45	0.30	LKG1V123MESAAK
12000	30 × 40	3.30	0.30	LKG1V123MESBAK
	35 × 30	3.40	0.30	LKG1V123MESCAK
	15000	30 × 45	3.80	0.30
35 × 35		3.80	0.30	LKG1V153MESCAK
18000	30 × 50	4.30	0.30	LKG1V183MESBAK
	35 × 40	4.15	0.30	LKG1V183MESCAK
22000	35 × 45	4.70	0.30	LKG1V223MESCAK

50V(1H)				
Cap. (μF)	Size φD × L(mm)	Rated ripple (Arms)	tan δ	Code
1500	22 × 20	1.55	0.30	LKG1H152MESZAK
1800	20 × 25	1.70	0.30	LKG1H182MESYAK
	25 × 20	1.65	0.30	LKG1H182MESAAK
2200	20 × 30	1.85	0.30	LKG1H222MESYAK
	22 × 25	1.85	0.30	LKG1H222MESZAK
2700	20 × 35	2.00	0.30	LKG1H272MESYAK
	22 × 30	2.00	0.30	LKG1H272MESZAK
	25 × 25	1.95	0.30	LKG1H272MESAAK
	30 × 20	2.05	0.30	LKG1H272MESBAK
3300	20 × 40	2.25	0.30	LKG1H332MESYAK
	22 × 35	2.20	0.30	LKG1H332MESZAK
3900	20 × 45	2.45	0.30	LKG1H392MESYAK
	22 × 40	2.35	0.30	LKG1H392MESZAK
	25 × 30	2.50	0.30	LKG1H392MESAAK
	30 × 25	2.35	0.30	LKG1H392MESBAK
4700	35 × 20	2.45	0.30	LKG1H392MESCAK
	20 × 50	2.75	0.30	LKG1H472MESYAK
	22 × 45	2.60	0.30	LKG1H472MESZAK
	25 × 35	2.70	0.30	LKG1H472MESAAK
5600	22 × 50	2.90	0.30	LKG1H562MESZAK
	25 × 40	2.90	0.30	LKG1H562MESAAK
	30 × 30	3.00	0.30	LKG1H562MESBAK
	35 × 25	2.85	0.30	LKG1H562MESCAK
6800	25 × 45	3.30	0.30	LKG1H682MESAAK
	30 × 35	3.25	0.30	LKG1H682MESBAK
8200	30 × 40	3.55	0.30	LKG1H822MESBAK
	35 × 30	3.65	0.30	LKG1H822MESCAK
10000	30 × 45	4.00	0.30	LKG1H103MESBAK
	35 × 35	4.00	0.30	LKG1H103MESCAK
12000	35 × 40	4.35	0.30	LKG1H123MESCAK
15000	35 × 50	4.70	0.30	LKG1H153MESCAK

Rated ripple current (Arms) at 85°C 120Hz



■ Dimensions (Snap-in Terminal Type : Grade TYPE- I )

63V(1J)				
Cap. (μF)	Size φD × L(mm)	Rated ripple (Arms)	tan δ	Code
820	22 × 20	1.30	0.30	LKG1J821MESZAK
1000	20 × 25	1.45	0.30	LKG1J102MESYAK
1200	25 × 20	1.65	0.30	LKG1J122MESAAK
1500	20 × 30	1.90	0.30	LKG1J152MESYAK
	22 × 25	1.90	0.30	LKG1J152MESZAK
1800	20 × 35	2.05	0.30	LKG1J182MESYAK
	22 × 30	2.00	0.30	LKG1J182MESZAK
	25 × 25	2.00	0.30	LKG1J182MESAAK
	30 × 20	2.05	0.30	LKG1J182MESBAK
	20 × 40	2.25	0.30	LKG1J222MESYAK
2200	22 × 35	2.20	0.30	LKG1J222MESZAK
	25 × 30	2.15	0.30	LKG1J222MESAAK
	35 × 20	2.10	0.30	LKG1J222MESCAK
	20 × 50	2.40	0.30	LKG1J272MESYAK
2700	22 × 40	2.45	0.30	LKG1J272MESZAK
	25 × 35	2.35	0.30	LKG1J272MESAAK
	30 × 25	2.50	0.30	LKG1J272MESBAK
	22 × 45	2.80	0.30	LKG1J332MESZAK
3300	25 × 40	2.60	0.30	LKG1J332MESAAK
	30 × 30	2.70	0.30	LKG1J332MESBAK
	25 × 45	2.85	0.30	LKG1J392MESAAK
3900	30 × 35	2.85	0.30	LKG1J392MESBAK
	35 × 25	3.00	0.30	LKG1J392MESCAK
	25 × 50	3.20	0.30	LKG1J472MESAAK
4700	30 × 40	3.10	0.30	LKG1J472MESBAK
	35 × 30	3.20	0.30	LKG1J472MESCAK
	30 × 45	3.45	0.30	LKG1J562MESBAK
5600	35 × 35	3.40	0.30	LKG1J562MESCAK
	30 × 50	3.90	0.30	LKG1J682MESBAK
6800	35 × 40	3.75	0.30	LKG1J682MESCAK
	35 × 45	4.20	0.30	LKG1J822MESCAK
10000	35 × 50	4.80	0.30	LKG1J103MESCAK

80V(1K)				
Cap. (μF)	Size φD × L(mm)	Rated ripple (Arms)	tan δ	Code
820	20 × 25	1.70	0.25	LKG1K821MESYAK
	25 × 20	1.65	0.25	LKG1K821MESAAK
1000	20 × 30	1.80	0.25	LKG1K102MESYAK
	22 × 25	1.85	0.25	LKG1K102MESZAK
1200	20 × 35	1.95	0.25	LKG1K122MESYAK
	22 × 30	1.95	0.25	LKG1K122MESZAK
	25 × 25	1.90	0.25	LKG1K122MESAAK
	30 × 20	2.00	0.25	LKG1K122MESBAK
1500	20 × 40	2.20	0.25	LKG1K152MESYAK
	22 × 35	2.15	0.25	LKG1K152MESZAK
	25 × 30	2.10	0.25	LKG1K152MESAAK
1800	20 × 45	2.45	0.25	LKG1K182MESYAK
	22 × 40	2.35	0.25	LKG1K182MESZAK
	30 × 25	2.40	0.25	LKG1K182MESBAK
	35 × 20	2.50	0.25	LKG1K182MESCAK
2200	22 × 45	2.70	0.25	LKG1K222MESZAK
	25 × 35	2.75	0.25	LKG1K222MESAAK
	30 × 30	2.55	0.25	LKG1K222MESBAK
2700	30 × 35	2.80	0.25	LKG1K272MESBAK
	35 × 25	3.00	0.25	LKG1K272MESCAK
3300	25 × 50	3.25	0.25	LKG1K332MESAAK
	30 × 40	3.15	0.25	LKG1K332MESBAK
	35 × 30	3.20	0.25	LKG1K332MESCAK
3900	30 × 45	3.45	0.25	LKG1K392MESBAK
	35 × 35	3.40	0.25	LKG1K392MESCAK
4700	30 × 45	3.85	0.25	LKG1K472MESBAK
	35 × 40	3.75	0.25	LKG1K472MESCAK
5600	35 × 45	4.10	0.25	LKG1K562MESCAK
6800	35 × 50	4.65	0.25	LKG1K682MESCAK

100V(2A)				
Cap. (μF)	Size φD × L(mm)	Rated ripple (Arms)	tan δ	Code
680	20 × 30	1.70	0.25	LKG2A681MESYAK
	22 × 25	1.75	0.25	LKG2A681MESZAK
820	20 × 35	1.85	0.25	LKG2A821MESYAK
	22 × 30	1.85	0.25	LKG2A821MESZAK
	25 × 25	1.80	0.25	LKG2A821MESAAK
	30 × 20	1.90	0.25	LKG2A821MESBAK
1000	20 × 40	2.05	0.25	LKG2A102MESYAK
1200	20 × 45	2.30	0.25	LKG2A122MESYAK
	22 × 40	2.20	0.25	LKG2A122MESZAK
	25 × 30	2.35	0.25	LKG2A122MESAAK
	30 × 25	2.20	0.25	LKG2A122MESBAK
	35 × 20	2.30	0.25	LKG2A122MESCAK
1500	20 × 50	2.65	0.25	LKG2A152MESYAK
	22 × 45	2.55	0.25	LKG2A152MESZAK
	25 × 35	2.60	0.25	LKG2A152MESAAK
1800	22 × 50	2.85	0.25	LKG2A182MESZAK
	25 × 40	2.85	0.25	LKG2A182MESAAK
	30 × 30	2.90	0.25	LKG2A182MESBAK
	35 × 25	2.75	0.25	LKG2A182MESCAK
2200	25 × 45	3.20	0.25	LKG2A222MESAAK
	30 × 35	3.20	0.25	LKG2A222MESBAK
	35 × 30	3.00	0.25	LKG2A222MESCAK
2700	30 × 40	3.55	0.25	LKG2A272MESBAK
	35 × 35	3.25	0.25	LKG2A272MESCAK
3300	30 × 50	3.75	0.25	LKG2A332MESBAK
3900	35 × 40	4.30	0.25	LKG2A392MESCAK
4700	35 × 50	4.50	0.25	LKG2A472MESCAK

Rated ripple current (Arms) at 85°C 120Hz

## LKG

■ Dimensions (Snap-in Terminal Type : Grade TYPE- II)

16V(1C)				
Cap. (μF)	Size φD × L(mm)	Rated ripple (Arms)	tan δ	Code
2200	20 × 20	1.10	0.35	LKG1C222MESYBK
3300	22 × 20	1.50	0.35	LKG1C332MESZBK
3900	20 × 25	1.55	0.35	LKG1C392MESYBK
	25 × 20	1.55	0.35	LKG1C392MESABK
4700	20 × 30	1.75	0.35	LKG1C472MESYBK
	22 × 25	1.75	0.35	LKG1C472MESZBK
5600	30 × 20	1.85	0.35	LKG1C562MESBBK
6800	20 × 35	2.20	0.35	LKG1C682MESYBK
	22 × 30	2.20	0.35	LKG1C682MESZBK
	25 × 25	2.15	0.35	LKG1C682MESABK
8200	20 × 40	2.40	0.35	LKG1C822MESYBK
	22 × 35	2.40	0.35	LKG1C822MESZBK
	25 × 30	2.30	0.35	LKG1C822MESABK
	35 × 20	2.25	0.35	LKG1C822MESCBK
10000	20 × 50	2.65	0.35	LKG1C103MESYBK
	22 × 40	2.65	0.35	LKG1C103MESZBK
	25 × 35	2.45	0.35	LKG1C103MESABK
	30 × 25	2.50	0.35	LKG1C103MESBBK
12000	22 × 50	2.75	0.35	LKG1C123MESZBK
	25 × 40	2.75	0.35	LKG1C123MESABK
	30 × 30	2.75	0.35	LKG1C123MESBBK
	35 × 25	2.60	0.35	LKG1C123MESCBK
15000	25 × 45	3.10	0.35	LKG1C153MESABK
	30 × 35	3.10	0.35	LKG1C153MESBBK
18000	25 × 50	3.50	0.35	LKG1C183MESABK
	30 × 40	3.40	0.35	LKG1C183MESBBK
	35 × 30	3.45	0.35	LKG1C183MESCBK
22000	30 × 45	3.80	0.35	LKG1C223MESBBK
	35 × 35	3.80	0.35	LKG1C223MESCBK
27000	30 × 50	4.25	0.45	LKG1C273MESBBK
	35 × 40	4.25	0.45	LKG1C273MESCBK
33000	35 × 45	4.50	0.57	LKG1C333MESCBK

35V(1V)				
Cap. (μF)	Size φD × L(mm)	Rated ripple (Arms)	tan δ	Code
1200	22 × 20	1.30	0.30	LKG1V122MESZBK
1500	22 × 25	1.40	0.30	LKG1V152MESYBK
1800	22 × 25	1.55	0.30	LKG1V182MESZBK
	25 × 20	1.65	0.30	LKG1V182MESABK
2200	20 × 30	1.75	0.30	LKG1V222MESYBK
2700	20 × 35	2.05	0.30	LKG1V272MESYBK
	22 × 30	2.05	0.30	LKG1V272MESZBK
	25 × 25	2.00	0.30	LKG1V272MESABK
	30 × 20	2.05	0.30	LKG1V272MESBBK
3300	20 × 40	2.25	0.30	LKG1V332MESYBK
	22 × 35	2.25	0.30	LKG1V332MESZBK
	25 × 30	2.20	0.30	LKG1V332MESABK
3900	20 × 45	2.40	0.30	LKG1V392MESYBK
	22 × 40	2.40	0.30	LKG1V392MESZBK
	25 × 35	2.30	0.30	LKG1V392MESABK
	30 × 25	2.40	0.30	LKG1V392MESBBK
4700	35 × 20	2.50	0.30	LKG1V392MESCBK
	22 × 45	2.70	0.30	LKG1V472MESZBK
	30 × 30	2.55	0.30	LKG1V472MESBBK
5600	22 × 50	3.00	0.30	LKG1V562MESZBK
	25 × 40	3.00	0.30	LKG1V562MESABK
	35 × 25	2.85	0.30	LKG1V562MESCBK
6800	25 × 50	3.10	0.30	LKG1V682MESABK
	30 × 35	3.30	0.30	LKG1V682MESBBK
	35 × 30	3.05	0.30	LKG1V682MESCBK
8200	30 × 40	3.60	0.30	LKG1V822MESBBK
	35 × 35	3.30	0.30	LKG1V822MESCBK
10000	30 × 50	3.80	0.30	LKG1V103MESBBK
	35 × 40	3.70	0.30	LKG1V103MESCBK
12000	35 × 45	4.10	0.30	LKG1V123MESCBK
15000	35 × 50	4.80	0.30	LKG1V153MESCBK

25V(1E)				
Cap. (μF)	Size φD × L(mm)	Rated ripple (Arms)	tan δ	Code
1800	20 × 20	1.35	0.30	LKG1E182MESYBK
2200	20 × 25	1.50	0.30	LKG1E222MESYBK
	25 × 20	1.50	0.30	LKG1E222MESABK
2700	20 × 30	1.70	0.30	LKG1E272MESYBK
	22 × 25	1.70	0.30	LKG1E272MESZBK
3300	20 × 35	1.80	0.30	LKG1E332MESYBK
	22 × 30	1.80	0.30	LKG1E332MESZBK
	30 × 20	1.85	0.30	LKG1E332MESBBK
3900	25 × 25	2.10	0.30	LKG1E392MESABK
4700	20 × 45	2.30	0.30	LKG1E472MESYBK
	22 × 35	2.30	0.30	LKG1E472MESZBK
	25 × 30	2.25	0.30	LKG1E472MESABK
	35 × 20	2.20	0.30	LKG1E472MESCBK
5600	20 × 50	2.50	0.30	LKG1E562MESYBK
	22 × 40	2.50	0.30	LKG1E562MESZBK
	25 × 35	2.40	0.30	LKG1E562MESABK
	30 × 25	2.50	0.30	LKG1E562MESBBK
6800	22 × 50	2.65	0.30	LKG1E682MESZBK
	25 × 40	2.65	0.30	LKG1E682MESABK
	30 × 30	2.65	0.30	LKG1E682MESBBK
8200	25 × 45	2.90	0.30	LKG1E822MESABK
	30 × 35	2.85	0.30	LKG1E822MESBBK
	35 × 25	3.05	0.30	LKG1E822MESCBK
10000	25 × 50	3.30	0.30	LKG1E103MESABK
	30 × 40	3.30	0.30	LKG1E103MESBBK
	35 × 30	3.30	0.30	LKG1E103MESCBK
12000	30 × 45	3.55	0.30	LKG1E123MESBBK
	35 × 35	3.50	0.30	LKG1E123MESCBK
15000	30 × 50	4.15	0.30	LKG1E153MESBBK
	35 × 40	4.00	0.30	LKG1E153MESCBK
18000	35 × 45	4.45	0.30	LKG1E183MESCBK

50V(1H)				
Cap. (μF)	Size φD × L(mm)	Rated ripple (Arms)	tan δ	Code
820	22 × 20	1.00	0.30	LKG1H821MESZBK
1000	20 × 25	1.50	0.30	LKG1H102MESYBK
	25 × 20	1.50	0.30	LKG1H102MESABK
1200	20 × 30	1.65	0.30	LKG1H122MESYBK
	22 × 25	1.65	0.30	LKG1H122MESZBK
1500	20 × 35	1.80	0.30	LKG1H152MESYBK
	22 × 30	1.80	0.30	LKG1H152MESZBK
	30 × 20	1.80	0.30	LKG1H152MESBBK
1800	25 × 25	2.15	0.30	LKG1H182MESABK
2200	20 × 45	2.35	0.30	LKG1H222MESYBK
	22 × 35	2.35	0.30	LKG1H222MESZBK
	25 × 30	2.30	0.30	LKG1H222MESABK
	35 × 20	2.25	0.30	LKG1H222MESCBK
2700	20 × 50	2.45	0.30	LKG1H272MESYBK
	22 × 45	2.45	0.30	LKG1H272MESZBK
	25 × 35	2.50	0.30	LKG1H272MESABK
	30 × 25	2.60	0.30	LKG1H272MESBBK
3300	22 × 50	2.80	0.30	LKG1H332MESZBK
	25 × 40	2.80	0.30	LKG1H332MESABK
	30 × 30	2.80	0.30	LKG1H332MESBBK
3900	25 × 45	3.00	0.30	LKG1H392MESABK
	30 × 35	3.00	0.30	LKG1H392MESBBK
	35 × 25	3.15	0.30	LKG1H392MESCBK
4700	25 × 50	3.40	0.30	LKG1H472MESABK
	30 × 40	3.30	0.30	LKG1H472MESBBK
	35 × 30	3.35	0.30	LKG1H472MESCBK
5600	30 × 45	3.60	0.30	LKG1H562MESBBK
	35 × 35	3.60	0.30	LKG1H562MESCBK
6800	30 × 50	4.10	0.30	LKG1H682MESBBK
	35 × 40	3.95	0.30	LKG1H682MESCBK
8200	35 × 45	4.40	0.30	LKG1H822MESCBK
10000	35 × 50	5.05	0.30	LKG1H103MESCBK

Rated ripple current (Arms) at 85°C 120Hz



■ Dimensions (Snap-in Terminal Type : Grade TYPE-II)

63V(1J)				
Cap. (μF)	Size φD × L(mm)	Rated ripple (Arms)	tan δ	Code
820	20 × 25	1.65	0.30	LKG1J821MESYBK
	25 × 20	1.65	0.30	LKG1J821MESABK
1000	20 × 30	1.85	0.30	LKG1J102MESYBK
	22 × 25	1.85	0.30	LKG1J102MESZBK
1200	20 × 35	1.95	0.30	LKG1J122MESYBK
	22 × 30	1.95	0.30	LKG1J122MESZBK
	25 × 25	1.90	0.30	LKG1J122MESABK
	30 × 20	1.95	0.30	LKG1J122MESBBK
1500	20 × 40	2.15	0.30	LKG1J152MESYBK
	22 × 35	2.15	0.30	LKG1J152MESZBK
	25 × 30	2.10	0.30	LKG1J152MESABK
1800	20 × 45	2.35	0.30	LKG1J182MESYBK
	22 × 40	2.35	0.30	LKG1J182MESZBK
	30 × 25	2.35	0.30	LKG1J182MESBBK
2200	35 × 20	2.45	0.30	LKG1J182MESCBK
	22 × 45	2.70	0.30	LKG1J222MESZBK
	25 × 35	2.75	0.30	LKG1J222MESABK
2700	30 × 30	2.50	0.30	LKG1J222MESBBK
	25 × 45	2.80	0.30	LKG1J272MESABK
	30 × 35	2.75	0.30	LKG1J272MESBBK
3300	35 × 25	2.95	0.30	LKG1J272MESCBK
	25 × 50	3.20	0.30	LKG1J332MESABK
	30 × 40	3.20	0.30	LKG1J332MESBBK
3900	35 × 30	3.15	0.30	LKG1J332MESCBK
	30 × 45	3.35	0.30	LKG1J392MESBBK
4700	35 × 35	3.35	0.30	LKG1J392MESCBK
5600	30 × 50	3.80	0.30	LKG1J472MESBBK
6800	35 × 40	4.35	0.30	LKG1J562MESCBK
	35 × 50	4.60	0.30	LKG1J682MESCBK

80V(1K)				
Cap. (μF)	Size φD × L(mm)	Rated ripple (Arms)	tan δ	Code
820	20 × 35	2.05	0.25	LKG1K821MESYBK
	22 × 30	2.05	0.25	LKG1K821MESZBK
	25 × 25	2.00	0.25	LKG1K821MESABK
	30 × 20	2.05	0.25	LKG1K821MESBBK
1000	20 × 45	2.20	0.25	LKG1K102MESYBK
	22 × 35	2.20	0.25	LKG1K102MESZBK
	25 × 30	2.15	0.25	LKG1K102MESABK
	35 × 20	2.10	0.25	LKG1K102MESCBK
1200	20 × 50	2.45	0.25	LKG1K122MESYBK
	22 × 40	2.45	0.25	LKG1K122MESZBK
	25 × 35	2.30	0.25	LKG1K122MESABK
	30 × 25	2.40	0.25	LKG1K122MESBBK
1500	22 × 50	2.60	0.25	LKG1K152MESZBK
	25 × 40	2.65	0.25	LKG1K152MESABK
	30 × 30	2.65	0.25	LKG1K152MESBBK
1800	25 × 45	2.85	0.25	LKG1K182MESABK
	30 × 35	2.85	0.25	LKG1K182MESBBK
	35 × 25	3.00	0.25	LKG1K182MESCBK
2200	25 × 50	3.25	0.25	LKG1K222MESABK
	30 × 40	3.15	0.25	LKG1K222MESBBK
	35 × 30	3.25	0.25	LKG1K222MESCBK
2700	30 × 45	3.60	0.25	LKG1K272MESBBK
	35 × 35	3.55	0.25	LKG1K272MESCBK
3300	30 × 50	4.10	0.25	LKG1K332MESBBK
	35 × 40	3.95	0.25	LKG1K332MESCBK
3900	35 × 45	4.35	0.25	LKG1K392MESCBK
4700	35 × 50	4.85	0.25	LKG1K472MESCBK

100V(2A)				
Cap. (μF)	Size φD × L(mm)	Rated ripple (Arms)	tan δ	Code
680	20 × 40	2.15	0.25	LKG2A681MESYBK
	22 × 35	2.15	0.25	LKG2A681MESZBK
	25 × 30	2.10	0.25	LKG2A681MESABK
820	20 × 45	2.40	0.25	LKG2A821MESYBK
	22 × 40	2.40	0.25	LKG2A821MESZBK
	30 × 25	2.35	0.25	LKG2A821MESBBK
1000	35 × 20	2.45	0.25	LKG2A821MESCBK
	22 × 45	2.70	0.25	LKG2A102MESZBK
	25 × 35	2.75	0.25	LKG2A102MESABK
1200	22 × 50	3.00	0.25	LKG2A122MESZBK
	25 × 40	2.75	0.25	LKG2A122MESABK
	30 × 30	3.05	0.25	LKG2A122MESBBK
	35 × 25	2.90	0.25	LKG2A122MESCBK
1500	25 × 50	3.20	0.25	LKG2A152MESABK
	30 × 35	3.40	0.25	LKG2A152MESBBK
	35 × 30	3.20	0.25	LKG2A152MESCBK
1800	30 × 40	3.70	0.25	LKG2A182MESBBK
	35 × 35	3.40	0.25	LKG2A182MESCBK
2200	30 × 50	3.95	0.25	LKG2A222MESBBK
	35 × 40	3.80	0.25	LKG2A222MESCBK
2700	35 × 45	4.30	0.25	LKG2A272MESCBK
3300	35 × 50	4.95	0.25	LKG2A332MESCBK

Rated ripple current (Arms) at 85°C 120Hz

## LKG

■ Dimensions (Snap-in Terminal Type : Grade TYPE-III)

16V(1C)				
Cap. (μF)	Size φD × L(mm)	Rated ripple (Arms)	tan δ	Code
1000	20 × 20	0.90	0.25	LKG1C102MESYCK
1200	22 × 20	0.95	0.25	LKG1C122MESZCK
1500	20 × 25	1.10	0.25	LKG1C152MESYCK
	25 × 20	1.10	0.25	LKG1C152MESACK
1800	22 × 25	1.20	0.25	LKG1C182MESZCK
2200	20 × 30	1.35	0.25	LKG1C222MESYCK
	30 × 20	1.35	0.25	LKG1C222MESBCK
2700	20 × 35	1.75	0.25	LKG1C272MESYCK
	25 × 25	1.75	0.25	LKG1C272MESACK
3300	20 × 40	2.00	0.25	LKG1C332MESYCK
	25 × 30	2.00	0.25	LKG1C332MESACK
	35 × 20	1.95	0.25	LKG1C332MESCK
3900	20 × 50	2.30	0.25	LKG1C392MESYCK
	22 × 45	2.30	0.25	LKG1C392MESZCK
	25 × 35	2.35	0.25	LKG1C392MESACK
4700	30 × 25	2.35	0.25	LKG1C392MESBCK
	22 × 50	2.75	0.25	LKG1C472MESZCK
	25 × 40	2.70	0.25	LKG1C472MESACK
	30 × 30	2.70	0.25	LKG1C472MESBCK
5600	35 × 25	2.60	0.25	LKG1C472MESCK
	25 × 45	2.90	0.25	LKG1C562MESACK
	30 × 35	2.90	0.25	LKG1C562MESBCK
6800	25 × 50	3.20	0.25	LKG1C682MESACK
	30 × 40	3.20	0.25	LKG1C682MESBCK
	35 × 30	3.15	0.25	LKG1C682MESCK
8200	30 × 45	3.35	0.25	LKG1C822MESBCK
	35 × 35	3.30	0.25	LKG1C822MESCK
10000	35 × 40	3.50	0.25	LKG1C103MESCK
12000	35 × 45	3.70	0.25	LKG1C123MESCK

25V(1E)				
Cap. (μF)	Size φD × L(mm)	Rated ripple (Arms)	tan δ	Code
680	20 × 20	0.65	0.22	LKG1E681MESYCK
820	22 × 20	0.75	0.22	LKG1E821MESZCK
1000	25 × 20	0.95	0.22	LKG1E102MESACK
1200	20 × 25	1.20	0.22	LKG1E122MESYCK
1500	20 × 30	1.30	0.22	LKG1E152MESYCK
	30 × 20	1.30	0.22	LKG1E152MESBCK
1800	20 × 35	1.60	0.22	LKG1E182MESYCK
	25 × 25	1.55	0.22	LKG1E182MESACK
2200	20 × 40	1.85	0.22	LKG1E222MESYCK
	22 × 35	1.85	0.22	LKG1E222MESZCK
	25 × 30	1.80	0.22	LKG1E222MESACK
	30 × 25	1.80	0.22	LKG1E222MESBCK
2700	35 × 20	1.75	0.22	LKG1E222MESCK
	20 × 50	2.20	0.22	LKG1E272MESYCK
	22 × 45	2.20	0.22	LKG1E272MESZCK
3300	25 × 35	2.15	0.22	LKG1E272MESACK
	22 × 50	2.50	0.22	LKG1E332MESZCK
	25 × 40	2.45	0.22	LKG1E332MESACK
	30 × 30	2.40	0.22	LKG1E332MESBCK
3900	35 × 25	2.45	0.22	LKG1E332MESCK
	25 × 45	2.80	0.22	LKG1E392MESACK
	30 × 35	2.80	0.22	LKG1E392MESBCK
4700	30 × 40	3.25	0.22	LKG1E472MESBCK
	35 × 30	3.15	0.22	LKG1E472MESCK
5600	30 × 45	3.50	0.22	LKG1E562MESBCK
	35 × 35	3.50	0.22	LKG1E562MESCK
6800	35 × 40	3.80	0.22	LKG1E682MESCK
8200	35 × 45	4.00	0.22	LKG1E822MESCK

35V(1V)				
Cap. (μF)	Size φD × L(mm)	Rated ripple (Arms)	tan δ	Code
820	20 × 25	0.85	0.22	LKG1V821MESYCK
	25 × 20	0.85	0.22	LKG1V821MESACK
1000	20 × 30	1.05	0.22	LKG1V102MESYCK
	22 × 25	1.00	0.22	LKG1V102MESZCK
1200	20 × 35	1.45	0.22	LKG1V122MESYCK
	22 × 30	1.45	0.22	LKG1V122MESZCK
	25 × 25	1.40	0.22	LKG1V122MESACK
	30 × 20	1.40	0.22	LKG1V122MESBCK
1500	20 × 40	1.55	0.22	LKG1V152MESYCK
	22 × 35	1.55	0.22	LKG1V152MESZCK
	25 × 30	1.50	0.22	LKG1V152MESACK
1800	20 × 45	1.80	0.22	LKG1V182MESYCK
	22 × 40	1.75	0.22	LKG1V182MESZCK
	30 × 25	1.75	0.22	LKG1V182MESBCK
	35 × 20	1.70	0.22	LKG1V182MESCK
2200	20 × 50	2.00	0.22	LKG1V222MESYCK
	22 × 45	1.95	0.22	LKG1V222MESZCK
	25 × 35	1.95	0.22	LKG1V222MESACK
	30 × 30	1.95	0.22	LKG1V222MESBCK
2700	25 × 45	2.35	0.22	LKG1V272MESACK
	30 × 35	2.30	0.22	LKG1V272MESBCK
	35 × 25	2.30	0.22	LKG1V272MESCK
3300	25 × 50	2.70	0.22	LKG1V332MESACK
	30 × 40	2.70	0.22	LKG1V332MESBCK
	35 × 30	2.65	0.22	LKG1V332MESCK
3900	30 × 45	3.00	0.22	LKG1V392MESBCK
	35 × 35	3.00	0.22	LKG1V392MESCK
4700	30 × 50	3.55	0.22	LKG1V472MESBCK
	35 × 40	3.55	0.22	LKG1V472MESCK
5600	35 × 45	3.80	0.22	LKG1V562MESCK
6800	35 × 50	4.15	0.22	LKG1V682MESCK

50V(1H)				
Cap. (μF)	Size φD × L(mm)	Rated ripple (Arms)	tan δ	Code
680	20 × 30	1.05	0.22	LKG1H681MESYCK
	22 × 25	1.00	0.22	LKG1H681MESZCK
820	22 × 30	1.40	0.22	LKG1H821MESZCK
	25 × 25	1.35	0.22	LKG1H821MESACK
	30 × 20	1.35	0.22	LKG1H821MESBCK
1000	20 × 35	1.80	0.22	LKG1H102MESYCK
	20 × 40	1.95	0.22	LKG1H122MESYCK
	25 × 30	1.95	0.22	LKG1H122MESACK
1200	30 × 25	1.90	0.22	LKG1H122MESBCK
	35 × 20	1.90	0.22	LKG1H122MESCK
	20 × 50	2.20	0.22	LKG1H152MESYCK
1500	22 × 45	2.20	0.22	LKG1H152MESZCK
	25 × 35	2.15	0.22	LKG1H152MESACK
	30 × 30	2.15	0.22	LKG1H152MESBCK
	22 × 50	2.45	0.22	LKG1H182MESZCK
1800	25 × 40	2.45	0.22	LKG1H182MESACK
	35 × 25	2.40	0.22	LKG1H182MESCK
	25 × 50	2.65	0.22	LKG1H222MESACK
2200	30 × 35	2.60	0.22	LKG1H222MESBCK
	35 × 30	2.60	0.22	LKG1H222MESCK
	30 × 45	3.00	0.22	LKG1H272MESBCK
2700	35 × 35	2.95	0.22	LKG1H272MESCK
	30 × 50	3.30	0.22	LKG1H332MESBCK
3300	35 × 40	3.25	0.22	LKG1H332MESCK
	3900	35 × 45	3.50	0.22
4700	35 × 50	3.90	0.22	LKG1H472MESCK

Rated ripple current (Arms) at 85°C 120Hz

## LKG

■ Dimensions (Snap-in Terminal Type : Grade TYPE-III)

63V(1J)				
Cap. (μF)	Size φD × L(mm)	Rated ripple (Arms)	tan δ	Code
680	20 × 30	1.75	0.22	LKG1J681MESYCK
	22 × 25	1.75	0.22	LKG1J681MESZCK
	30 × 20	1.90	0.22	LKG1J681MESBCK
820	20 × 35	1.90	0.22	LKG1J821MESYCK
	22 × 30	1.90	0.22	LKG1J821MESZCK
	25 × 25	1.85	0.22	LKG1J821MESACK
1000	20 × 40	2.10	0.22	LKG1J102MESYCK
	22 × 35	2.05	0.22	LKG1J102MESZCK
	25 × 30	2.00	0.22	LKG1J102MESACK
1200	20 × 45	2.35	0.22	LKG1J122MESYCK
	22 × 40	2.25	0.22	LKG1J122MESZCK
	30 × 25	2.20	0.22	LKG1J122MESBCK
	35 × 20	2.30	0.22	LKG1J122MESACK
1500	22 × 45	2.60	0.22	LKG1J152MESZCK
	25 × 35	2.65	0.22	LKG1J152MESACK
1800	22 × 50	2.90	0.22	LKG1J182MESZCK
	25 × 40	2.90	0.22	LKG1J182MESACK
	30 × 30	2.90	0.22	LKG1J182MESBCK
	35 × 25	2.75	0.22	LKG1J182MESACK
2200	25 × 45	3.25	0.22	LKG1J222MESACK
	30 × 35	3.20	0.22	LKG1J222MESBCK
2700	30 × 45	3.30	0.22	LKG1J272MESBCK
	35 × 30	3.65	0.22	LKG1J272MESACK
3300	30 × 50	3.80	0.22	LKG1J332MESBCK
	35 × 35	4.00	0.22	LKG1J332MESACK
3900	35 × 40	4.30	0.22	LKG1J392MESACK
4700	35 × 50	4.50	0.22	LKG1J472MESACK

80V(1K)				
Cap. (μF)	Size φD × L(mm)	Rated ripple (Arms)	tan δ	Code
680	20 × 45	2.10	0.20	LKG1K681MESYCK
	22 × 35	2.25	0.20	LKG1K681MESZCK
	25 × 30	2.15	0.20	LKG1K681MESACK
820	20 × 50	2.40	0.20	LKG1K821MESYCK
	22 × 40	2.45	0.20	LKG1K821MESZCK
	25 × 35	2.35	0.20	LKG1K821MESACK
	30 × 25	2.40	0.20	LKG1K821MESBCK
1000	35 × 20	2.55	0.20	LKG1K821MESACK
	22 × 50	2.60	0.20	LKG1K102MESZCK
	25 × 40	2.60	0.20	LKG1K102MESACK
1200	30 × 30	2.60	0.20	LKG1K102MESBCK
	25 × 45	2.85	0.20	LKG1K122MESACK
	30 × 35	2.80	0.20	LKG1K122MESBCK
1500	35 × 25	2.95	0.20	LKG1K122MESACK
	25 × 50	3.30	0.20	LKG1K152MESACK
	30 × 40	3.20	0.20	LKG1K152MESBCK
1800	35 × 30	3.25	0.20	LKG1K152MESACK
	30 × 45	3.55	0.20	LKG1K182MESBCK
	35 × 35	3.50	0.20	LKG1K182MESACK
2200	30 × 50	4.05	0.20	LKG1K222MESBCK
	35 × 40	3.90	0.20	LKG1K222MESACK
2700	35 × 45	4.45	0.20	LKG1K272MESACK
3300	35 × 50	5.05	0.20	LKG1K332MESACK

100V(2A)				
Cap. (μF)	Size φD × L(mm)	Rated ripple (Arms)	tan δ	Code
680	22 × 45	2.65	0.20	LKG2A681MESZCK
	25 × 35	2.70	0.20	LKG2A681MESACK
820	22 × 50	3.00	0.20	LKG2A821MESZCK
	25 × 40	3.00	0.20	LKG2A821MESACK
	30 × 30	3.00	0.20	LKG2A821MESBCK
	35 × 25	2.85	0.20	LKG2A821MESACK
1000	25 × 50	3.10	0.20	LKG2A102MESACK
	30 × 35	3.30	0.20	LKG2A102MESBCK
	35 × 30	3.05	0.20	LKG2A102MESACK
1200	30 × 40	3.60	0.20	LKG2A122MESBCK
	35 × 35	3.30	0.20	LKG2A122MESACK
1500	30 × 50	3.90	0.20	LKG2A152MESBCK
	35 × 40	3.75	0.20	LKG2A152MESACK
1800	35 × 45	4.15	0.20	LKG2A182MESACK
2200	35 × 50	4.75	0.20	LKG2A222MESACK

Rated ripple current (Arms) at 85°C 120Hz

## LKG

### ■ Dimensions (Lug Terminal Type : Grade TYPE- I )

Rated Voltage (V)(code)	Cap. (μF)	Size φD × L(mm)	Rated ripple (Arms)	tan δ	Code
50V(1H)	22000	40 × 68	5.40	0.30	LKG1H223MKNF
63V(1J)	15000	40 × 68	5.60	0.30	LKG1J153MKNF
	22000	40 × 100	6.60	0.30	LKG1J223MKNF
80V(1K)	10000	40 × 68	5.40	0.25	LKG1K103MKNF
	15000	40 × 100	6.50	0.25	LKG1K153MKNF
	22000	50 × 100	7.80	0.25	LKG1K223MKZF
100V(2A)	6800	40 × 68	5.10	0.25	LKG2A682MKNF
	10000	40 × 100	6.00	0.25	LKG2A103MKNF
	15000	50 × 100	7.40	0.25	LKG2A153MKZF
	22000	63 × 80	9.70	0.25	LKG2A223MKZF

### ■ Dimensions (Lug Terminal Type : Grade TYPE- II )

Rated Voltage (V)(code)	Cap. (μF)	Size φD × L(mm)	Rated ripple (Arms)	tan δ	Code
50(1H)	10000	35 × 80	4.60	0.30	LKG1H103MKN
	15000	40 × 80	6.10	0.30	LKG1H153MKN
	22000	50 × 80	8.30	0.30	LKG1H223MKZ
63(1J)	6800	35 × 68	4.30	0.30	LKG1J682MKN
	10000	40 × 80	4.90	0.30	LKG1J103MKN
	15000	40 × 100	6.70	0.30	LKG1J153MKN
	22000	50 × 100	9.10	0.30	LKG1J223MKZ
80(1K)	6800	40 × 100	6.10	0.25	LKG1K682MKN
	10000	50 × 80	6.20	0.25	LKG1K103MKZ
	15000	50 × 100	8.40	0.25	LKG1K153MKZ
	22000	63 × 100	11.6	0.25	LKG1K223MKZ
100(2A)	6800	50 × 80	6.20	0.25	LKG2A682MKZ
	10000	50 × 100	6.90	0.25	LKG2A103MKZ
	15000	63 × 80	8.70	0.25	LKG2A153MKZ
	22000	76 × 100	12.9	0.25	LKG2A223MKZ

### ■ Dimensions (Lug Terminal Type : Grade TYPE- III )

Rated Voltage (V)(code)	Cap. (μF)	Size φD × L(mm)	Rated ripple (Arms)	tan δ	Code
50(1H)	6800	40 × 80	5.50	0.22	LKG1H682MKNS
	10000	40 × 100	6.10	0.22	LKG1H103MKNS
	15000	50 × 100	8.40	0.22	LKG1H153MKZS
	22000	63 × 80	10.5	0.22	LKG1H223MKZS
63(1J)	6800	40 × 100	6.10	0.22	LKG1J682MKNS
	10000	50 × 80	6.20	0.22	LKG1J103MKZS
	15000	63 × 80	8.70	0.22	LKG1J153MKZS
	22000	63 × 100	11.6	0.22	LKG1J223MKZS
80(1K)	6800	50 × 80	6.70	0.20	LKG1K682MKZS
	10000	63 × 80	7.60	0.20	LKG1K103MKZS
	15000	63 × 100	10.1	0.20	LKG1K153MKZS
	22000	76 × 100	13.7	0.20	LKG1K223MKZS
100(2A)	6800	50 × 100	7.30	0.20	LKG2A682MKZS
	10000	63 × 100	8.30	0.20	LKG2A103MKZS
	15000	76 × 100	11.3	0.20	LKG2A153MKZS

Rated ripple current (Arms) at 85°C 120Hz