

Description

The DIODES™ AP7368 is a low dropout regulator featuring 500mA/1A that provides high output voltage accuracy, low $R_{DS(on)}$, high PSRR, low output noise, and low quiescent current. This regulator is based on a CMOS process.

The AP7368 includes a voltage reference, error amplifier, current-limit circuit, and enable inputs to turn on and off separately. With the integrated resistor network, fixed output voltage versions can be delivered.

With the device's low power consumption and line and load transient response, the AP7368 is well suited for low power handheld communication equipment.

The AP7368 can select the output current limit 1.0A or 500mA by alternating the LCON pin between "H" or "L".

The AP7368 is packaged in the X1-DFN1612-8 (Type B) package, allowing for the smallest footprint and a dense PCB layout.

Features

- Low V_{IN} and Wide V_{IN} Range: 1.7V to 5.5V
- Guarantee Output Current: 500mA/1A (set by LCON)
- V_{OUT} Accuracy $\pm 1\%$
- Ripple Rejection 80dB at 1kHz
- Low Output Noise, 16 μ Vrms from 10Hz to 100kHz
- Quiescent Current as Low as 110 μ A
- V_{OUT} Fixed 0.9V to 3.3V
- Inrush Current Limit: 300mA (LCON="L")
- Foldback Short Circuit Protection: 60mA (LCON="L")
- **Totally Lead-Free & Fully RoHS Compliant (Notes 1 & 2)**
- **Halogen and Antimony Free. "Green" Device (Note 3)**
- **For automotive applications requiring specific change control (i.e. parts qualified to AEC-Q100/101/104/200, PPAP capable, and manufactured in IATF 16949 certified facilities), please [contact us](mailto:contact@diodes.com) or your local Diodes representative. <https://www.diodes.com/quality/product-definitions/>**

- Notes:
1. No purposely added lead. Fully EU Directive 2002/95/EC (RoHS), 2011/65/EU (RoHS 2) & 2015/863/EU (RoHS 3) compliant.
 2. See <https://www.diodes.com/quality/lead-free/> for more information about Diodes Incorporated's definitions of Halogen- and Antimony-free, "Green" and Lead-free.
 3. Halogen- and Antimony-free "Green" products are defined as those which contain <900ppm bromine, <900ppm chlorine (<1500ppm total Br + Cl) and <1000ppm antimony compounds.

Typical Applications Circuit

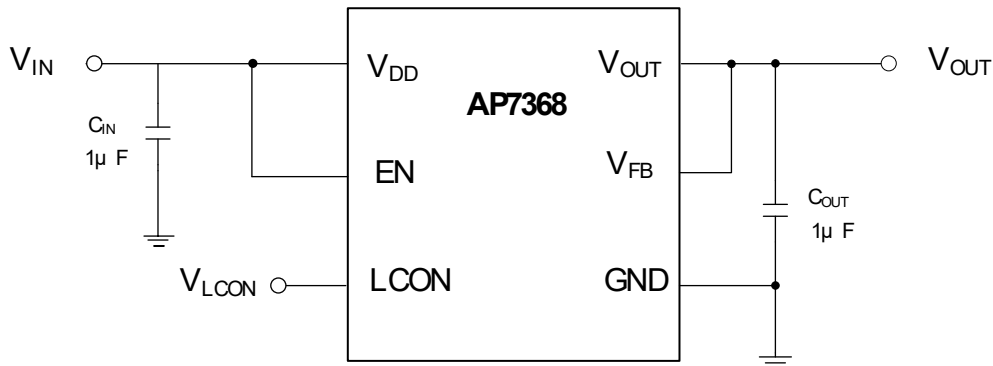

Pin Assignments

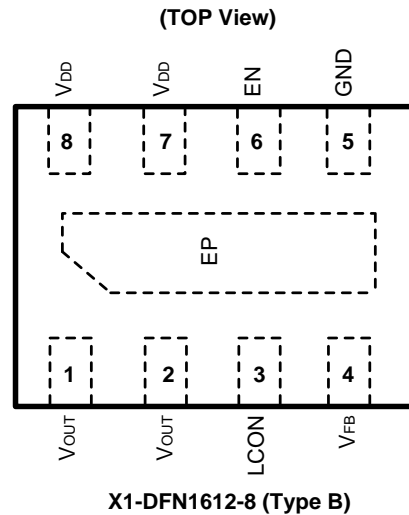

Applications

- Smart Phones/Tablets
- RF Supplies
- Cameras
- Portable Videos
- Portable Media Players
- Wireless Adapters
- Wireless Communication

Pin Descriptions

Pin Number	Pin Name	Function
1, 2	V _{OUT}	Output Voltage Pin
3	LCON	Output Current Limit Setting Pin ("H"=1A, "L"=500mA)
4	V _{FB}	Feedback Voltage Pin
5	GND	Ground
6	EN	Enable Pin This pin should be driven either high or low and must not be floating. Driving this pin high enables the regulator, while pulling it low puts the regulator into shutdown mode
7,8	V _{DD}	Power Input Pin
EP	Exposed Pad	In PCB layout, prefer to use large copper area to cover this pad for better thermal dissipation, then connect this area to GND or leave it open. However, do not use it as GND electrode function alone

Functional Block Diagram

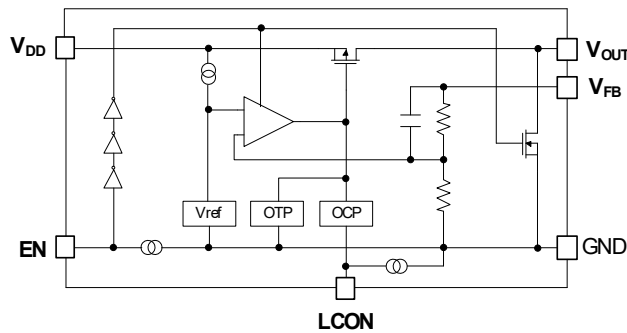

Absolute Maximum Ratings (Note 4) (@T_A = +25°C, unless otherwise specified.)

Symbol	Parameter	Ratings	Unit
ESD HBM	Human Body Mode ESD Protection	> 2	KV
ESD MM	Machine Mode ESD Protection	> 200	V
V _{IN}	Input Voltage	6.0	V
V _{EN}	Input Voltage for EN Pin	6.0	V
V _{OUT}	Output Voltage	-0.3 to V _{IN} + 0.3	V
I _{OUT}	Each Channel Output Current	1000	mA
P _D	Power Dissipation	1700	mW
T _A	Operating Ambient Temperature	-40 to +85	°C
T _J	Operating Junction Temperature	-40 to +150	°C
T _{STG}	Storage Temperature	-55 to +150	°C

- Note:
- a). Stresses beyond those listed under Absolute Maximum Ratings may cause permanent damage to the device. These are stress ratings only and functional operation of the device at these conditions is not implied. Exposure to absolute-maximum-rated conditions for extended period may affect device reliability.
 - b). Ratings apply to ambient temperature at +25°C. The JEDEC High-K board design used to derive this data was a 3 inch x 3 inch multilayer board with 1oz. internal power and ground planes and 2oz. copper traces on the top and bottom of the board.

Recommended Operating Conditions (@T_A = +25°C, unless otherwise specified.)

Symbol	Parameter	Min	Max	Unit
V _{IN}	Input Voltage	1.7	5.5	V
I _{OUT}	Each Channel Output Current	0	1000	mA
T _A	Operating Ambient Temperature	-40	+85	°C

Electrical Characteristics (@T_A = +25°C, V_{DD} = V_{OUT} + 1.0V, C_{IN} = C_{OUT} = 1.0μF, I_{OUT} = 1.0mA, unless otherwise specified.)

Parameter	Condition	Min	Typ	Max	Units	
Input Voltage	T _A = -40°C to +85°C	1.7	-	5.5	V	
Output Voltage Accuracy	T _A = -40°C to +85°C	V _{OUT(T)} * 0.99	V _{OUT(T)}	V _{OUT(T)} * 1.01	V	
Line Regulation (dV _{OUT} /dV _{IN} /V _{OUT})	V _{IN} = (V _{OUT-Nom} + 1.0V) to 5.5V, I _{OUT} = 1.0mA	-	0.02	0.1	%/V	
Load Regulation	V _{IN} = V _{OUT} + 1V, I _{OUT} = 1mA to 500mA, LCON="L"	-	1	20	mV	
	V _{IN} = V _{OUT} + 1V, I _{OUT} = 1mA to 1A, LCON="H"	-	1	40		
Quiescent Current (Note 6)	I _{OUT} = 0mA	-	110	170	μA	
I _{STANDBY}	V _{EN} = 0V (Disabled)	-	0.5	3	μA	
Output Current Limit	V _{IN} = V _{OUT} + 1V	LCON="L"	500	-	-	mA
		LCON="H"	1	-	-	A
Foldback Short Current (Note 7)	V _{OUT} Short to Ground, LCON="L"	-	60	-	mA	
	V _{OUT} Short to Ground, LCON="H"	-	110	-		
PSRR (Note 8)	V _{IN} = (V _{OUT} +1V) V _{DC} + 0.2Vp-pAC, I _{OUT} = 30mA, V _{OUT} ≥ 1.8V	f = 1kHz	-	80	-	dB
	V _{IN} = (V _{OUT} +1V) V _{DC} + 0.2Vp-pAC, I _{OUT} = 30mA, V _{OUT} ≤ 1.8V		-	75	-	
Output Noise Voltage (Note 8) (Note 9)	BW = 10Hz to 100kHz, I _{OUT} = 100mA	-	16	-	μVrms	
Dropout Voltage (Note 5)	I _{OUT} = 500mA	0.9V ≤ V _{OUT} ≤ 1.5V	-	(Note 10)	(Note 10)	V
		V _{OUT} =1.8V	-	0.095	0.135	
		V _{OUT} =2.5V	-	0.074	0.105	
		V _{OUT} =2.8V	-	0.07	0.1	
		V _{OUT} =2.85V	-	0.07	0.1	
		V _{OUT} =3.0V	-	0.066	0.095	
		V _{OUT} =3.3V	-	0.06	0.09	
	I _{OUT} = 1A	0.9V ≤ V _{OUT} ≤ 1.2V	-	(Note 10)	(Note 10)	
		V _{OUT} =1.5V	-	0.24	0.33	
		V _{OUT} =1.8V	-	0.2	0.28	
		V _{OUT} =2.5V	-	0.155	0.22	
		V _{OUT} =2.8V	-	0.145	0.205	
		V _{OUT} =2.85V	-	0.145	0.205	
		V _{OUT} =3.0V	-	0.14	0.2	
V _{OUT} =3.3V	-	0.125	0.19			
Output Voltage Temperature Coefficient	I _{OUT} = 30mA, T _A = -40°C to +85°C	-	±30	-	ppm/°C	
Thermal Shutdown Threshold (TSHDN)	-	-	+150	-	°C	
Thermal Shutdown Hysteresis (THYS)	-	-	+20	-	°C	
EN Input Low Voltage	-	0	-	0.4	V	
EN Input High Voltage	-	1	-	5.5	V	
EN Input Leakage	V _{EN} = 0, V _{IN} = 5.0V or V _{EN} = 5.0V, V _{IN} = 0V	-	-	0.6	μA	
LCON Pull-down Current	-	-	0.3	-	μA	
LCON Input Low Voltage	-	-	-	0.4	V	
LCON Input High Voltage	-	1	-	-	V	
Inrush Current Limit	-	LCON="L"	-	300	-	mA
		LCON="H"	-	500	-	
On Resistance of N-Channel for Auto-Discharge	V _{IN} = 4.0V, V _{EN} = 0V (Disabled)	-	30	-	Ω	

- Notes:
- Dropout voltage is the voltage difference between the input and the output at which the output voltage drops 2% below its nominal value.
 - Quiescent current is defined here is the difference in current between the input and the output.
 - Short circuit current is measured with V_{OUT} pulled to GND.
 - This specification is guaranteed by design.
 - To make sure lowest environment noise minimizes the influence on noise measurement.
 - Input voltage should be equal or more than the minimum operating voltage

Electrical Characteristics (@T_A = +25°C, V_{DD} = V_{OUT} + 1.0V, C_{IN} = C_{OUT} = 1.0μF, I_{OUT} = 1.0mA, unless otherwise specified.) (cont.)

Parameter	Condition	Min	Typ	Max	Units
Thermal Resistance Junction to Ambient (θ _{JA}) (Note 4)	X1-DFN1612-8 (Type B)	-	55.5	-	°C/W
Thermal Resistance Junction to Case (θ _{JC}) (Note 4)	X1-DFN1612-8 (Type B)	-	15.4	-	

- Notes:
- 5. Dropout voltage is the voltage difference between the input and the output at which the output voltage drops 2% below its nominal value.
 - 6. Quiescent current is defined here is the difference in current between the input and the output.
 - 7. Short circuit current is measured with V_{OUT} pulled to GND.
 - 8. This specification is guaranteed by design.
 - 9. To make sure lowest environment noise minimizes the influence on noise measurement.
 - 10. Input voltage should be equal or more than the minimum operating voltage

Typical Performance Characteristics

1) Output Voltage vs. Input Voltage (C_{IN} = Ceramic 1.0 μ F, C_{OUT} = Ceramic 1.0 μ F, T_a = 25°C)

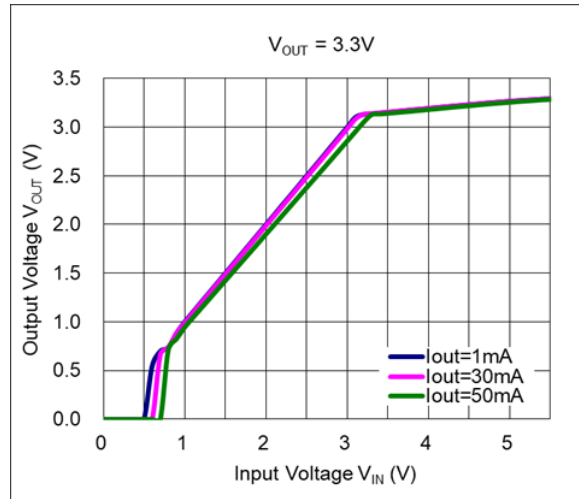
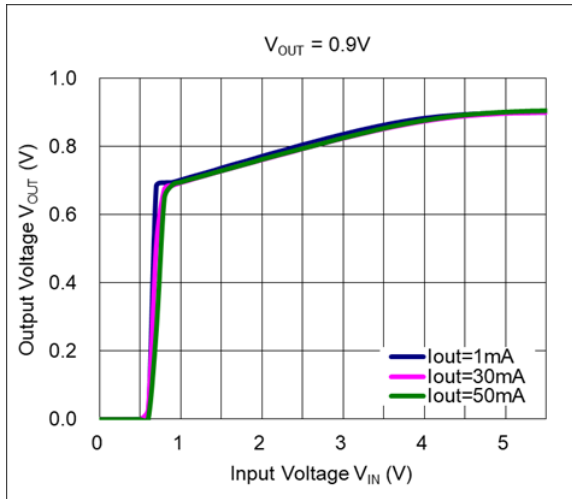

2) Supply Current vs. Input Voltage (C_{IN} = Ceramic 1.0 μ F, C_{OUT} = Ceramic 1.0 μ F, T_a = 25°C)

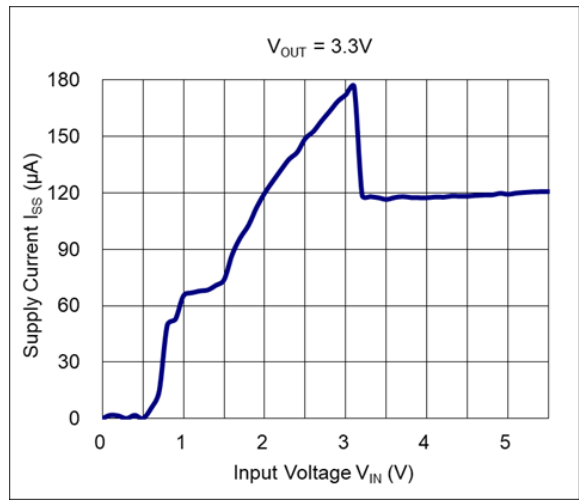
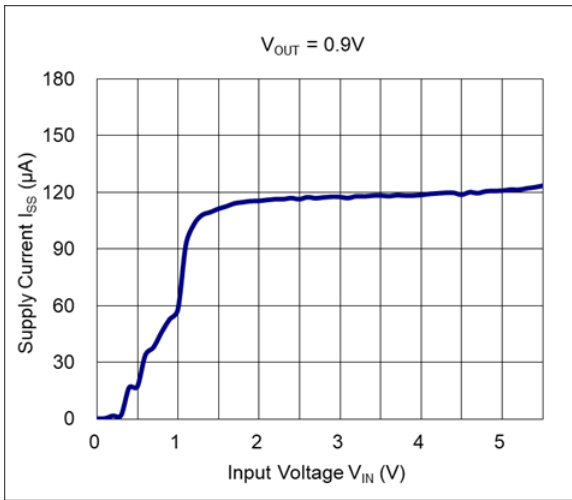

3) Short Current Limit vs. Temperature

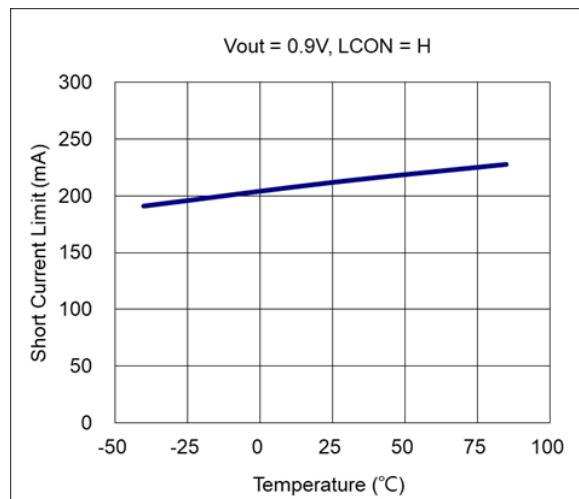
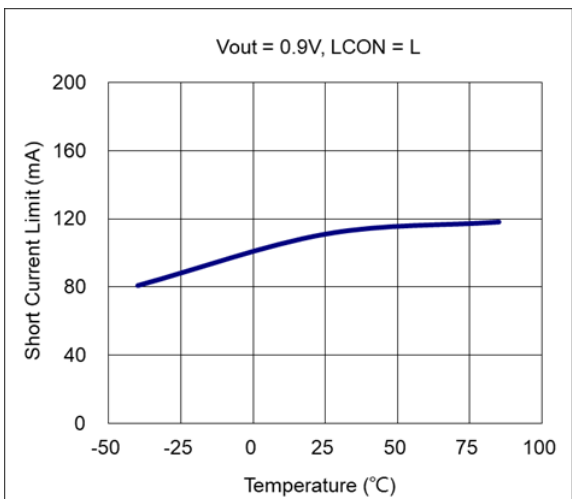

Typical Performance Characteristics (continued)

4) Peak Current Limit vs. Temperature (C_{IN} = Ceramic 1.0 μ F, C_{OUT} = Ceramic 1.0 μ F, $V_{IN}=V_{OUT}+1V$)

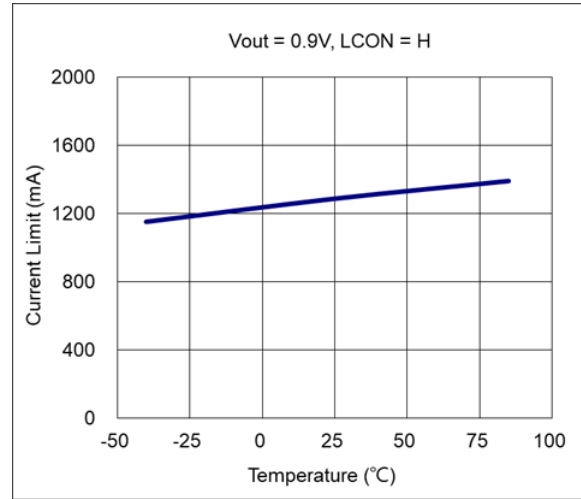
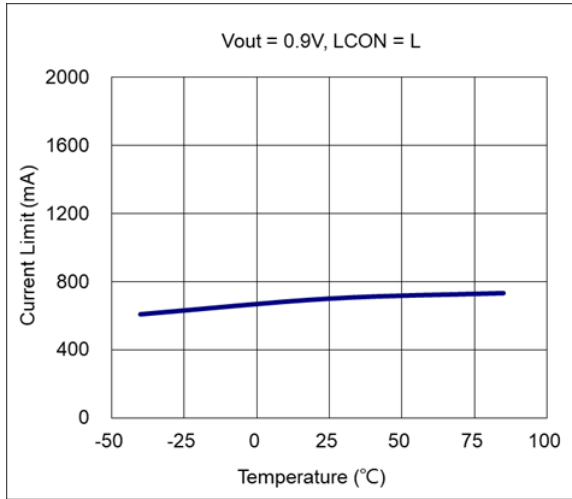

5) Output Voltage vs. Temperature (C_{IN} = Ceramic 1.0 μ F, C_{OUT} = Ceramic 1.0 μ F, $V_{IN}=V_{OUT}+1V$, I_{OUT} = 1 mA)

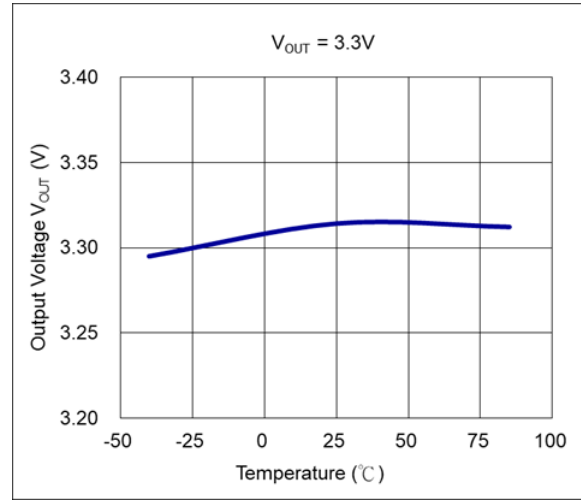
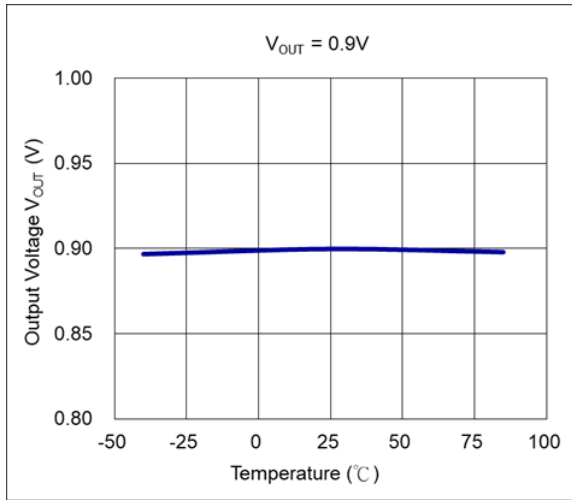

6) Supply Current vs. Temperature (C_{IN} = Ceramic 1.0 μ F, C_{OUT} = Ceramic 1.0 μ F, $V_{IN}=V_{OUT}+1V$, I_{OUT} = 0 mA)

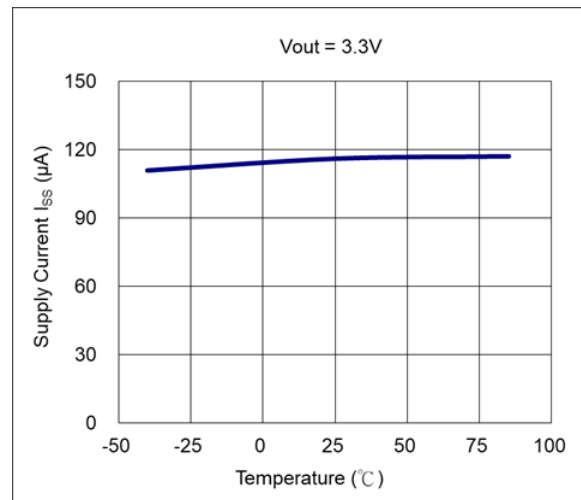
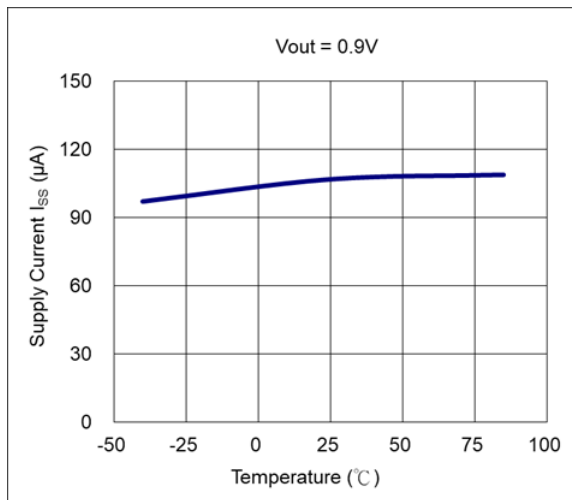

Typical Performance Characteristics (continued)

7) Dropout Voltage vs. Output Current ($C_{IN} = \text{Ceramic } 1.0 \mu\text{F}$, $C_{OUT} = \text{Ceramic } 1.0 \mu\text{F}$, $V_{IN}=V_{OUT}+1\text{V}$)

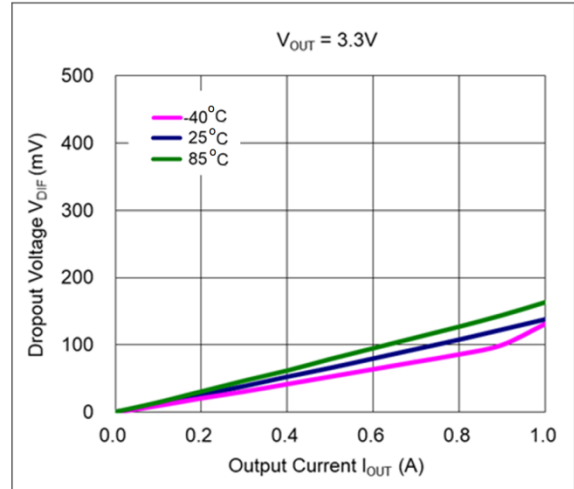
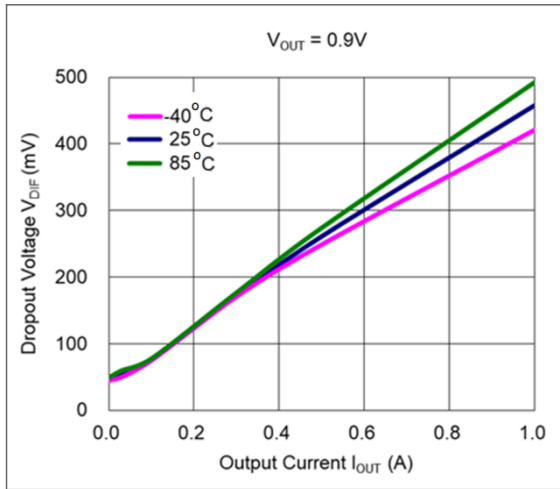

8) Dropout Voltage vs. Set Output Voltage ($C_{IN} = \text{Ceramic } 1.0 \mu\text{F}$, $C_{OUT} = \text{Ceramic } 1.0 \mu\text{F}$, $T_a = 25^\circ\text{C}$)

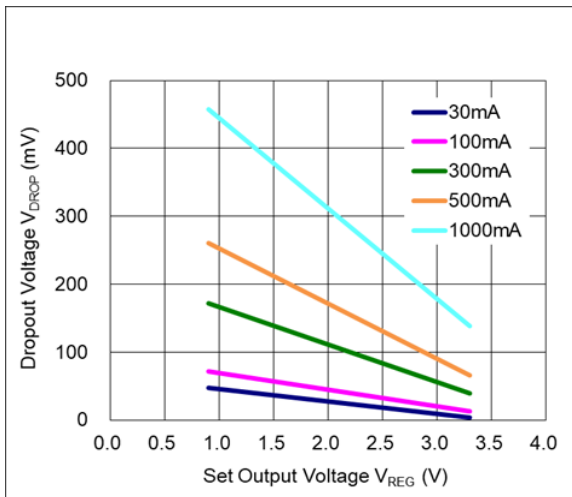

9) Dropout Voltage vs. Temperature ($C_{IN} = \text{Ceramic } 1.0 \mu\text{F}$, $C_{OUT} = \text{Ceramic } 1.0 \mu\text{F}$)

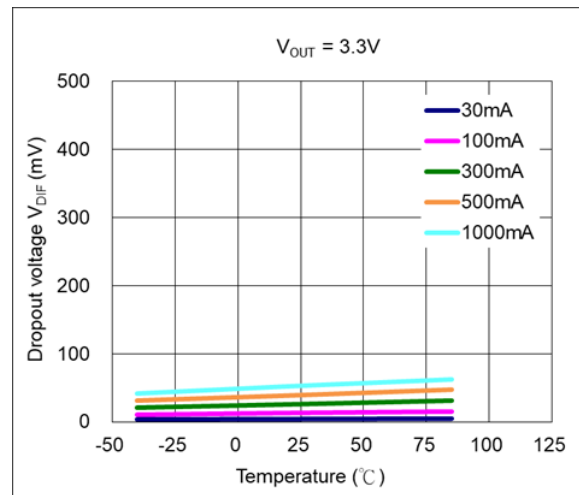
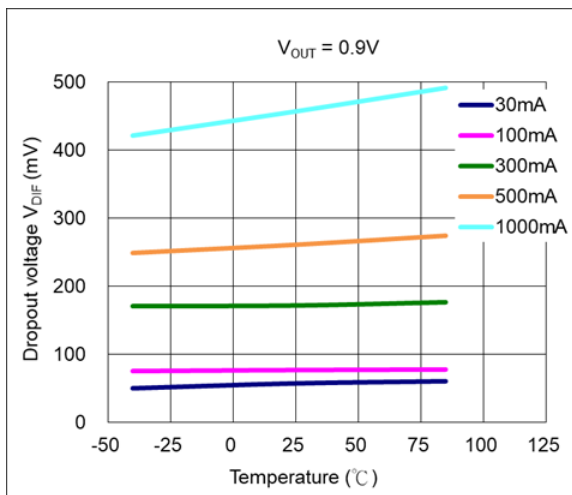

Typical Performance Characteristics (continued)

10) Ripple Rejection vs. Input Voltage ($C_{IN} = \text{none}$, $C_{OUT} = \text{Ceramic } 1.0 \mu\text{F}$, Ripple = 0.2 Vp-p, $T_a = 25^\circ\text{C}$)

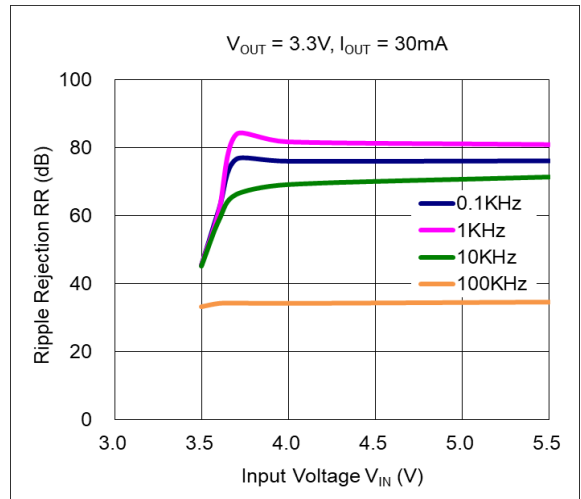
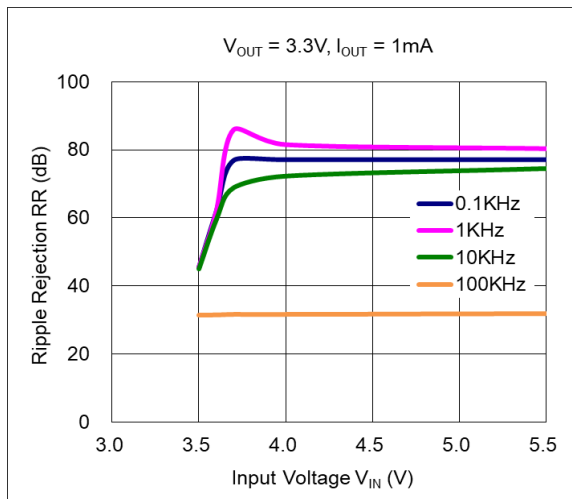
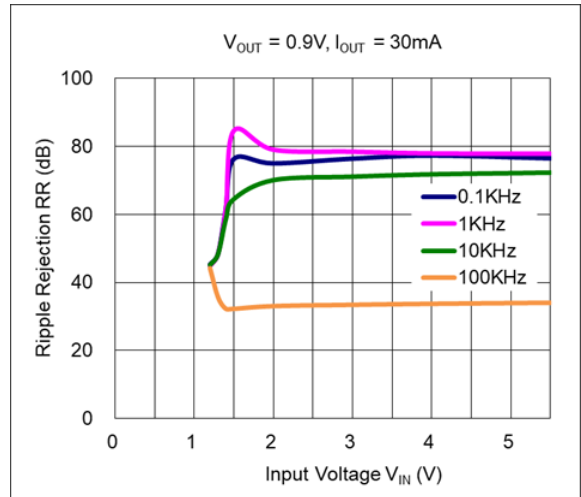
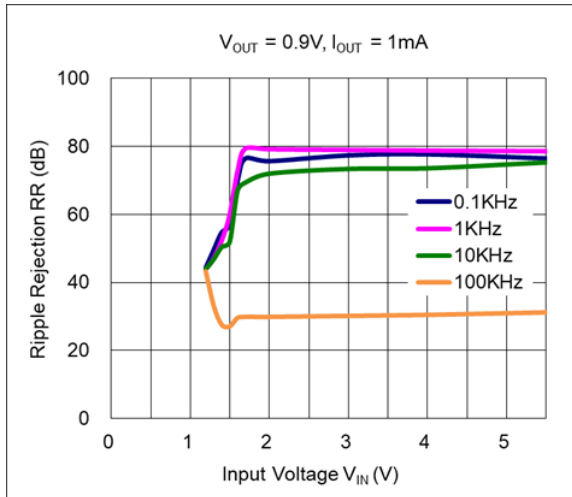

11) Ripple Rejection vs. Frequency ($C_{IN} = \text{none}$, $C_{OUT} = \text{Ceramic } 1.0 \mu\text{F}$, Ripple = 0.2 Vp-p, $T_a = 25^\circ\text{C}$)

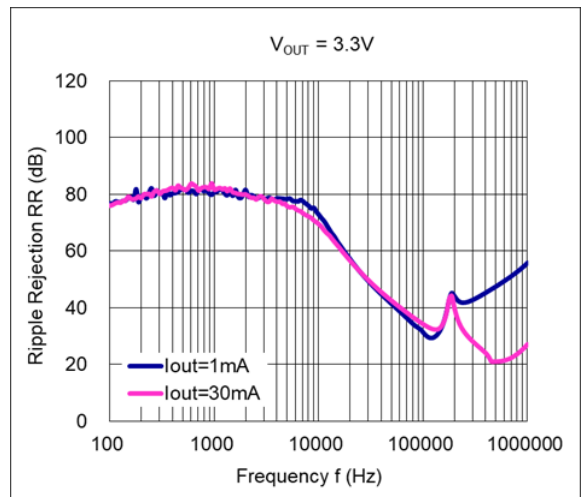
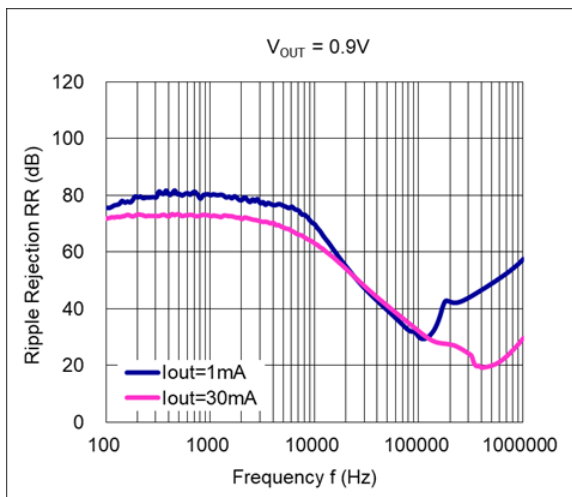

Typical Performance Characteristics (continued)

12) Line Transient Response $C_{IN} = \text{none}$, $C_{OUT} = \text{Ceramic } 1.0 \mu\text{F}$, $I_{OUT} = 30 \text{ mA}$, $t_r = t_f = 5 \mu\text{s}$, $T_a = 25^\circ\text{C}$

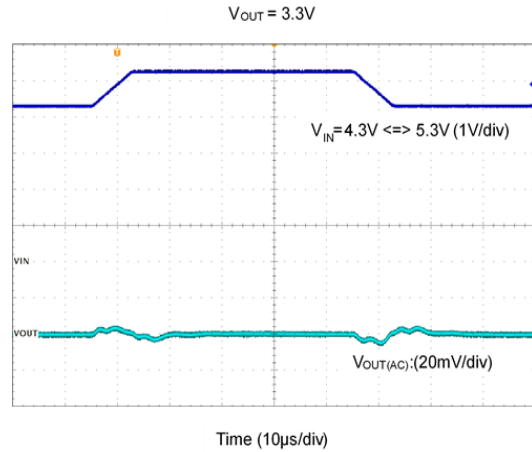
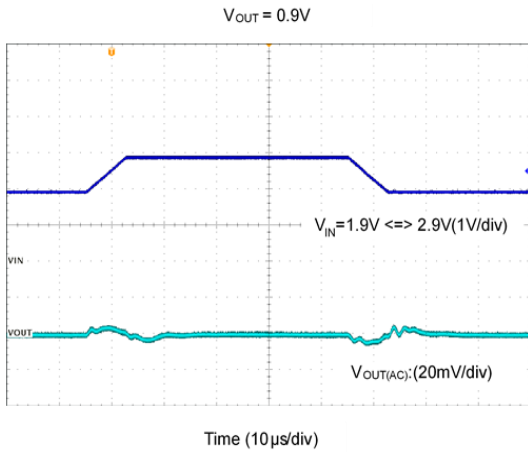

13) Load Transient Response ($C_{IN} = \text{Ceramic } 1.0 \mu\text{F}$, $C_{OUT} = \text{Ceramic } 1.0 \mu\text{F}$, $t_r = t_f = 0.5 \mu\text{s}$, $T_a = 25^\circ\text{C}$)

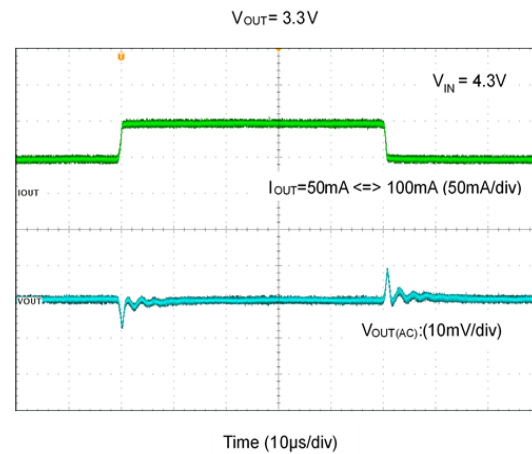
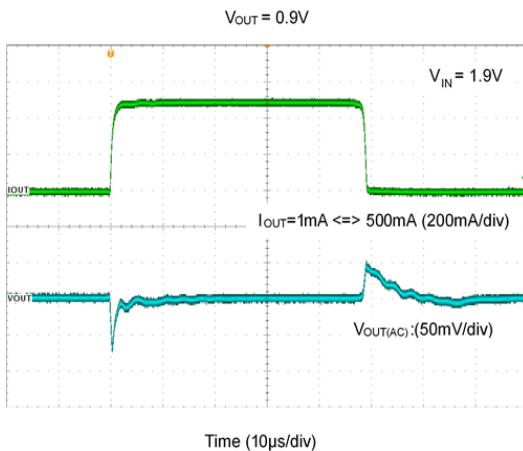
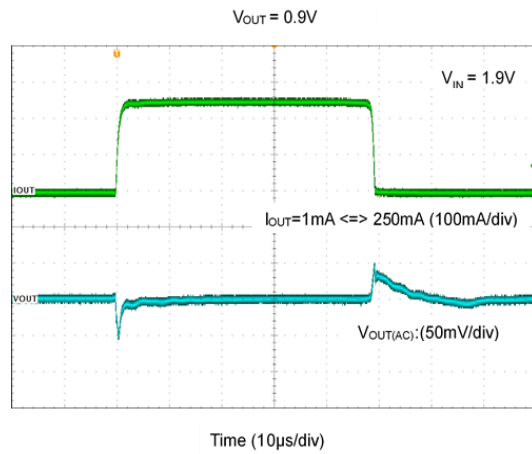
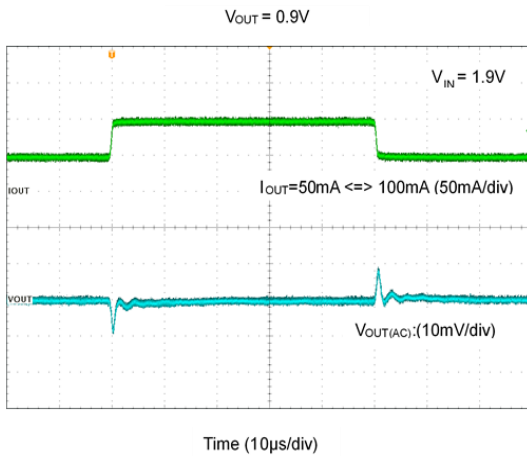

Typical Performance Characteristics

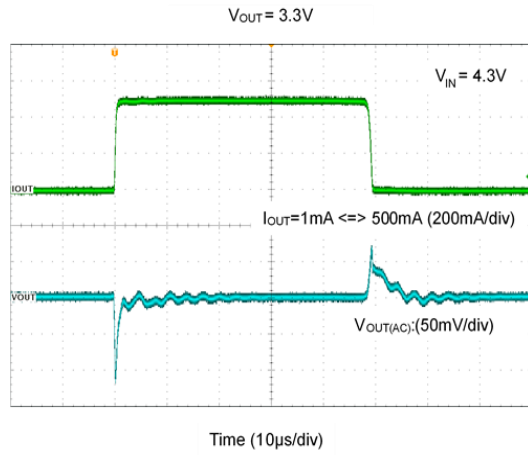
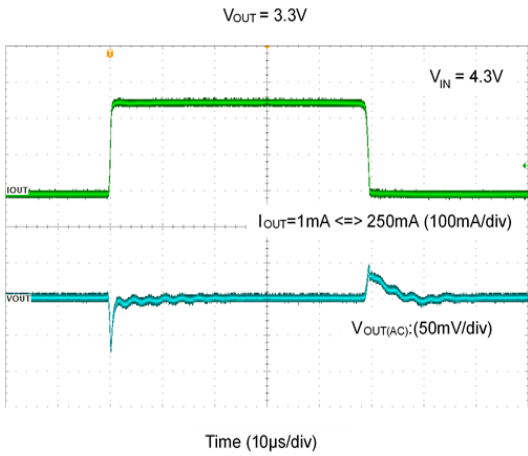

14) Turn-on Waveform by EN Pin Signal ($C_{IN} = \text{Ceramic } 1.0 \mu\text{F}$, $C_{OUT} = \text{Ceramic } 1.0 \mu\text{F}$, $T_a = 25^\circ\text{C}$)

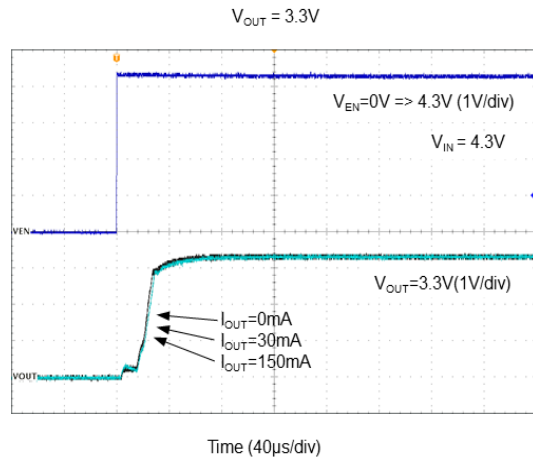
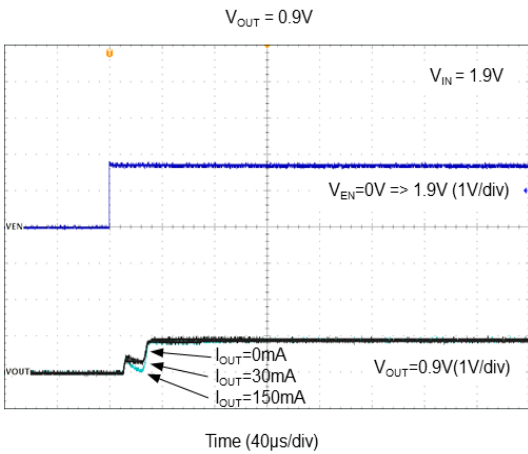

15) Turn-off Waveform by EN Pin Signal ($C_{IN} = \text{Ceramic } 1.0 \mu\text{F}$, $C_{OUT} = \text{Ceramic } 1.0 \mu\text{F}$, $T_a = 25^\circ\text{C}$)

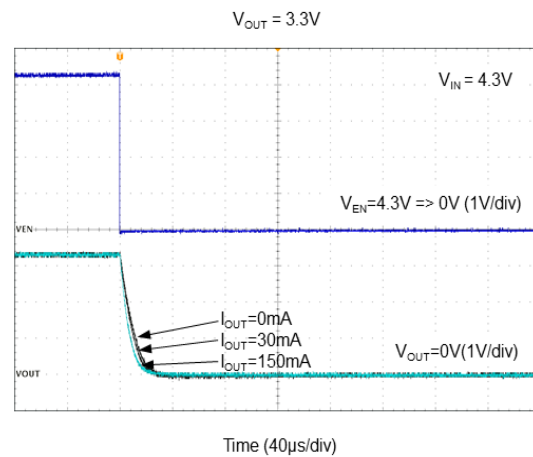
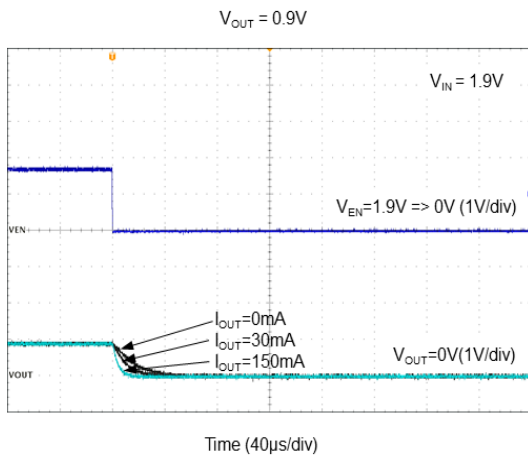

Typical Performance Characteristics

16) LCON Pin Transient Response (C_{IN} = Ceramic 1.0 μ F, C_{OUT} = Ceramic 1.0 μ F, T_a = 25°C)

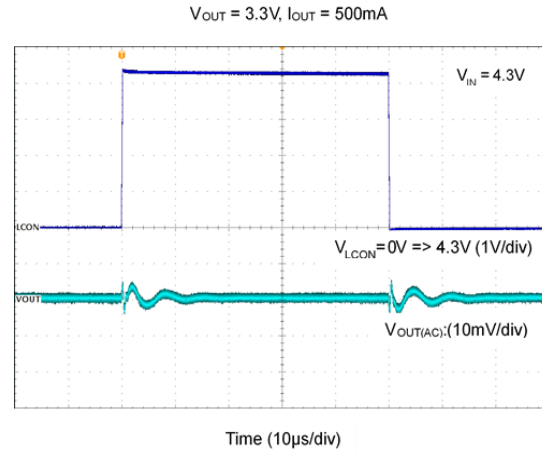
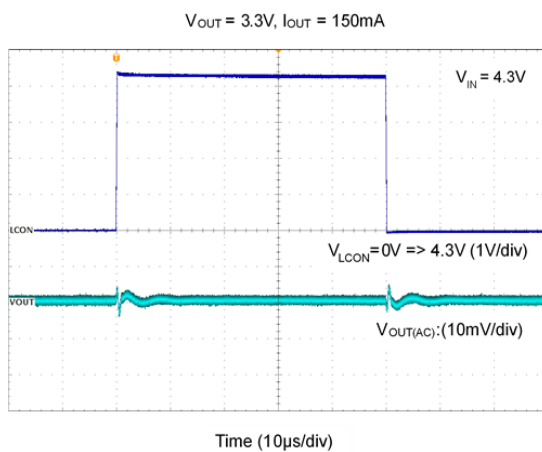
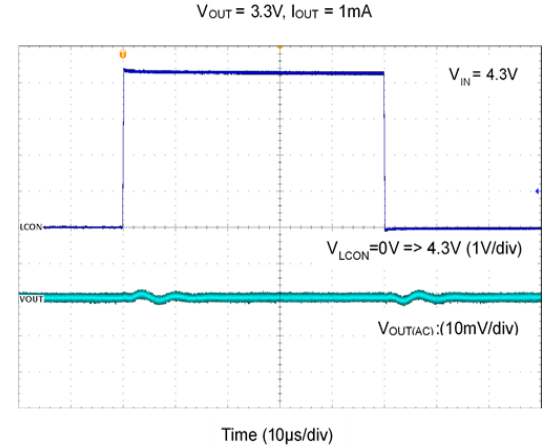
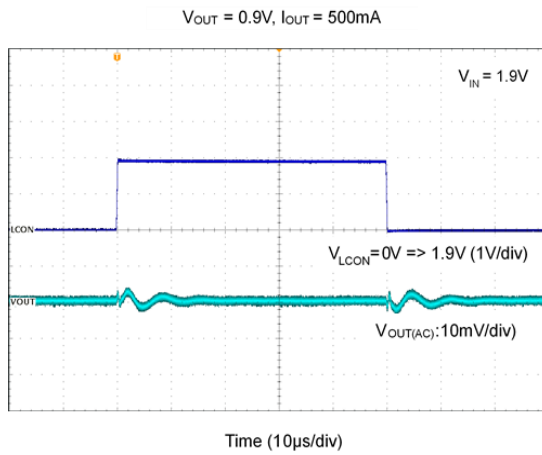
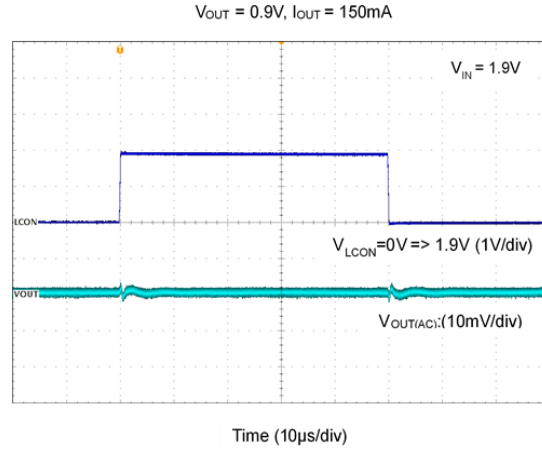
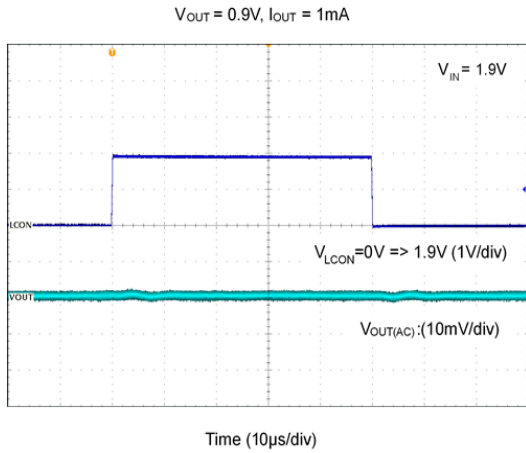

Application Information

Overview

The AP7368 is a low dropout regulator featuring 500mA/1A and provides high output voltage accuracy, low $R_{DS(on)}$, high PSRR, low output noise, and low quiescent current. The AP7368 is well suited for low power handheld communication equipment.

Output Capacitor

An output capacitor (C_{OUT}) is needed to improve transient response and maintain stability. The AP7368 is stable with very small ceramic output capacitors. The ESR (equivalent series resistance) and capacitance drives the selection. If the application has large load variations, it is recommended to utilize low-ESR bulk capacitors. It is recommended to place ceramic capacitors as close as possible to the load and the ground pin and care should be taken to reduce the impedance in the layout.

Input Capacitor

To prevent the input voltage from dropping during load steps, it is recommended to utilize an input capacitor (C_{IN}). A minimum 1 μ F ceramic capacitor is recommended between V_{IN} and GND pins to decouple input power supply glitch. This input capacitor must be located as close as possible to the device to assure input stability and reduce noise. For PCB layout, a wide copper trace is required for both V_{IN} and GND pins.

Enable Control

The AP7368 is turned on by setting the EN pin high, and is turned off by pulling it low. If this feature is not used, the EN pin should be tied to V_{IN} pin to keep the regulator output on at all times. To ensure proper operation, the signal source used to drive the EN pin must be able to swing above and below the specified turn-on/off voltage thresholds listed in the Electrical Characteristics section.

LCON Pin

The AP7368 can select the output current limit 1A or 500mA by alternating the LCON pin between "H" or "L".

- LCON = "L" 500mA
- LCON = "H" 1A

Short Circuit Protection

When V_{OUT} pin is short-circuit to GND, short circuit protection will be triggered and clamp the output current to approximately 60mA. This feature protects the regulator from overcurrent and damage due to overheating.

Layout Considerations

For good ground loop and stability, the input and output capacitors should be located close to the input, output, and ground pins of the device. The regulator ground pin should be connected to the external circuit ground to reduce voltage drop caused by trace impedance. Ground plane is generally used to reduce trace impedance. Wide trace should be used for large current paths from V_{IN} to V_{OUT} , and load circuit.

ESR vs. Output Current

Ceramic type output capacitor is recommended for this AP7368; however, the other output capacitors with low ESR also can be used. The relations between I_{OUT} (Output Current) and ESR of an output capacitor are shown below. The stable region is marked as the hatched area in the graph.

Measurement conditions: Frequency Band: 10Hz to 2MHz, Temperature: -40°C to $+85^{\circ}\text{C}$.

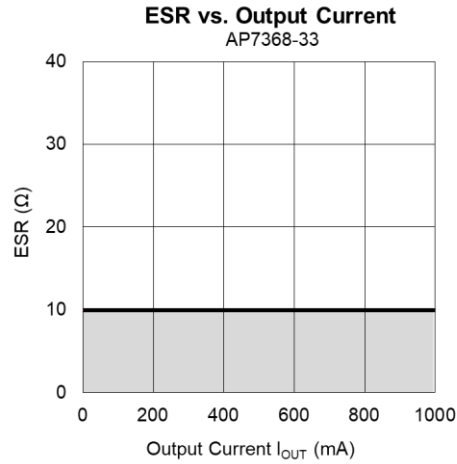
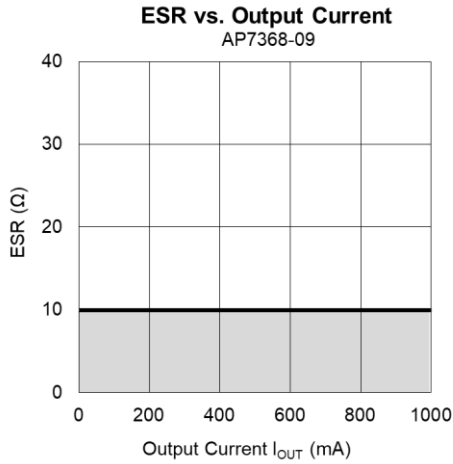

Ordering Information (Note 11)

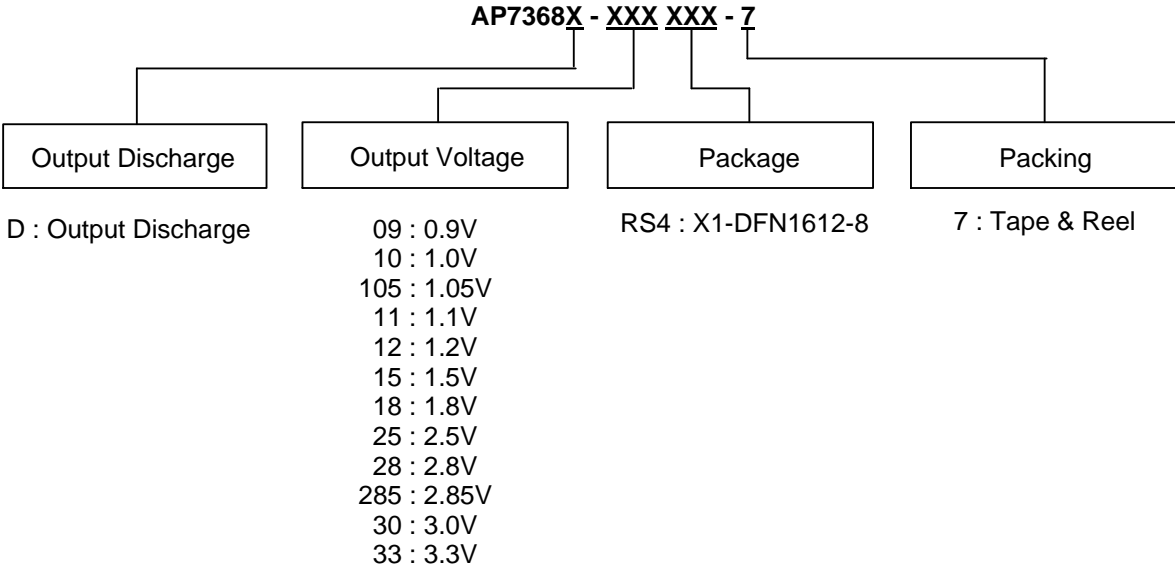

Part Number	Package Code	Package	7" Tape and Reel	
			Quantity	Part Number Suffix
AP7368D-XXRS4-7	RS4	X1-DFN1612-8 (Type B)	5,000/Tape & Reel	-7

Note: 11. For packaging details, go to our website at <https://www.diodes.com/design/support/packaging/diodes-packaging/>.

Marking Information

(1) X1-DFN1612-8 (Type B)

(Top View)

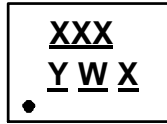

XXX : Identification Code
Y : Year : 0~9
W : Week : A~Z : 1~26 week;
a~z : 27~52 week; z represents
52 and 53 week
X : Internal code

Part Number	Package	Identification Code
AP7368D-09RS4-7	X1-DFN1612-8 (Type B)	H9A
AP7368D-10RS4-7	X1-DFN1612-8 (Type B)	H9B
AP7368D-105RS4-7	X1-DFN1612-8 (Type B)	H9R
AP7368D-11RS4-7	X1-DFN1612-8 (Type B)	H9N
AP7368D-12RS4-7	X1-DFN1612-8 (Type B)	H9C
AP7368D-15RS4-7	X1-DFN1612-8 (Type B)	H9D
AP7368D-18RS4-7	X1-DFN1612-8 (Type B)	H9E
AP7368D-25RS4-7	X1-DFN1612-8 (Type B)	H9F
AP7368D-28RS4-7	X1-DFN1612-8 (Type B)	H9G
AP7368D-285RS4-7	X1-DFN1612-8 (Type B)	H9P
AP7368D-30RS4-7	X1-DFN1612-8 (Type B)	H9H
AP7368D-33RS4-7	X1-DFN1612-8 (Type B)	H9J

Package Outline Dimensions

Please see <http://www.diodes.com/package-outlines.html> for the latest version.

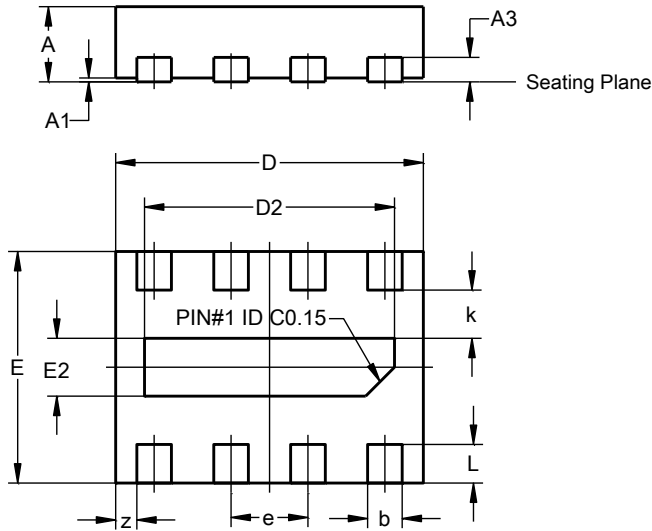

X1-DFN1612-8 (Type B)			
Dim	Min	Max	Typ
A	0.36	0.43	0.39
A1	0.00	0.05	0.02
A3	--	--	0.127
b	0.13	0.23	0.18
D	1.55	1.65	1.60
D2	1.20	1.40	1.30
E	1.15	1.25	1.20
E2	0.20	0.40	0.30
e	--	--	0.40
k	--	--	0.25
L	0.15	0.25	0.20
z	--	--	0.11
All Dimensions in mm			

Suggested Pad Layout

Please see <http://www.diodes.com/package-outlines.html> for the latest version.

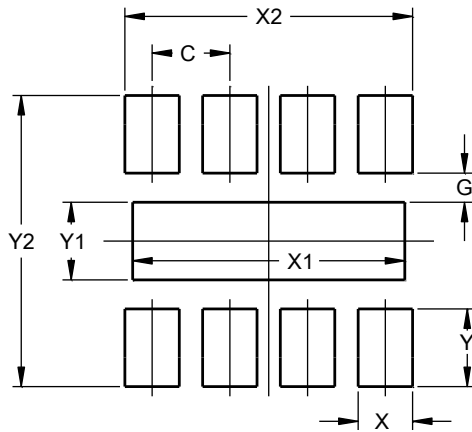

Dimensions	Value (in mm)
C	0.400
G	0.150
X	0.280
X1	1.400
X2	1.480
Y	0.400
Y1	0.400
Y2	1.500

Mechanical Data

- Moisture Sensitivity: Level 1 Per J-STD-020
- Terminals: Finish - NiPdAu over Copper Leads, Solderable per JESD22-B102 Test Method 208 @4
- Weight: 0.003grams (Approximate)

IMPORTANT NOTICE

1. DIODES INCORPORATED (Diodes) AND ITS SUBSIDIARIES MAKE NO WARRANTY OF ANY KIND, EXPRESS OR IMPLIED, WITH REGARDS TO ANY INFORMATION CONTAINED IN THIS DOCUMENT, INCLUDING, BUT NOT LIMITED TO, THE IMPLIED WARRANTIES OF MERCHANTABILITY, FITNESS FOR A PARTICULAR PURPOSE OR NON-INFRINGEMENT OF THIRD PARTY INTELLECTUAL PROPERTY RIGHTS (AND THEIR EQUIVALENTS UNDER THE LAWS OF ANY JURISDICTION).
2. The Information contained herein is for informational purpose only and is provided only to illustrate the operation of Diodes' products described herein and application examples. Diodes does not assume any liability arising out of the application or use of this document or any product described herein. This document is intended for skilled and technically trained engineering customers and users who design with Diodes' products. Diodes' products may be used to facilitate safety-related applications; however, in all instances customers and users are responsible for (a) selecting the appropriate Diodes products for their applications, (b) evaluating the suitability of Diodes' products for their intended applications, (c) ensuring their applications, which incorporate Diodes' products, comply the applicable legal and regulatory requirements as well as safety and functional-safety related standards, and (d) ensuring they design with appropriate safeguards (including testing, validation, quality control techniques, redundancy, malfunction prevention, and appropriate treatment for aging degradation) to minimize the risks associated with their applications.
3. Diodes assumes no liability for any application-related information, support, assistance or feedback that may be provided by Diodes from time to time. Any customer or user of this document or products described herein will assume all risks and liabilities associated with such use, and will hold Diodes and all companies whose products are represented herein or on Diodes' websites, harmless against all damages and liabilities.
4. Products described herein may be covered by one or more United States, international or foreign patents and pending patent applications. Product names and markings noted herein may also be covered by one or more United States, international or foreign trademarks and trademark applications. Diodes does not convey any license under any of its intellectual property rights or the rights of any third parties (including third parties whose products and services may be described in this document or on Diodes' website) under this document.
5. Diodes' products are provided subject to Diodes' Standard Terms and Conditions of Sale (<https://www.diodes.com/about/company/terms-and-conditions/terms-and-conditions-of-sales/>) or other applicable terms. This document does not alter or expand the applicable warranties provided by Diodes. Diodes does not warrant or accept any liability whatsoever in respect of any products purchased through unauthorized sales channel.
6. Diodes' products and technology may not be used for or incorporated into any products or systems whose manufacture, use or sale is prohibited under any applicable laws and regulations. Should customers or users use Diodes' products in contravention of any applicable laws or regulations, or for any unintended or unauthorized application, customers and users will (a) be solely responsible for any damages, losses or penalties arising in connection therewith or as a result thereof, and (b) indemnify and hold Diodes and its representatives and agents harmless against any and all claims, damages, expenses, and attorney fees arising out of, directly or indirectly, any claim relating to any noncompliance with the applicable laws and regulations, as well as any unintended or unauthorized application.
7. While efforts have been made to ensure the information contained in this document is accurate, complete and current, it may contain technical inaccuracies, omissions and typographical errors. Diodes does not warrant that information contained in this document is error-free and Diodes is under no obligation to update or otherwise correct this information. Notwithstanding the foregoing, Diodes reserves the right to make modifications, enhancements, improvements, corrections or other changes without further notice to this document and any product described herein. This document is written in English but may be translated into multiple languages for reference. Only the English version of this document is the final and determinative format released by Diodes.
8. Any unauthorized copying, modification, distribution, transmission, display or other use of this document (or any portion hereof) is prohibited. Diodes assumes no responsibility for any losses incurred by the customers or users or any third parties arising from any such unauthorized use.
9. This Notice may be periodically updated with the most recent version available at <https://www.diodes.com/about/company/terms-and-conditions/important-notice>

DIODES is a trademark of Diodes Incorporated in the United States and other countries.
The Diodes logo is a registered trademark of Diodes Incorporated in the United States and other countries.
© 2022 Diodes Incorporated. All Rights Reserved.

www.diodes.com