

# Miniature PCB Relays 8 - 10 - 12 - 16 A



Medical and dentistry



Control panels



Panels for electrical distribution



Toys



Automation for blinds, grilles and shutters



Door and gate openers

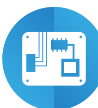

Electronic circuit boards



Vending machines

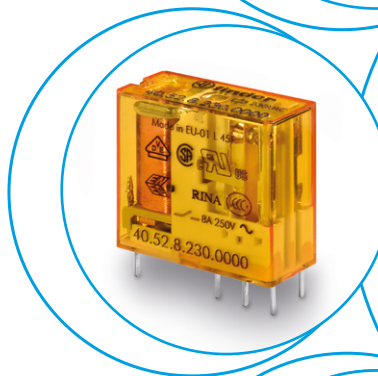



**Power relays 1 and 2 pole for direct PCB or socket mount**

**Type 40.31/51**

- 1 CO 12 A (3.5 mm pin pitch)
- 1 CO 12 A (5.0 mm pin pitch)

**Type 40.52**

- 2 CO 8 A (5.0 mm pin pitch)

**Type 40.61**

- 1 CO 16 A (5.0 mm pin pitch)

- Pin length 3.5 mm for PCB mount
- Pin length 5.2 mm for Plug-in mount
- DC coils (650 mW or 500 mW) and AC coils
- 8 mm Creepage and Clearance, 6 kV (1.2/50µs) between coil and contact
- Meets EN 60335-1 glow wire requirements
- 95 series sockets for PCB or 35 mm rail mounting (EN 60715) with Screw, Screwless or Push-in terminals
- Coil Indication and EMC suppression modules 99 series and Timer module 86.30 options
- Environmental protection:  
RT II - flux proof (Standard)  
RT III - wash tight (Option)

\* Mounted on sockets ≤ 10 A

\*\* With the AgSnO<sub>2</sub> material the maximum peak current on normally open contact, is 120 A - 5 ms (for 40.61) and 60 A - 5 ms (for 40.52)

FOR UL RATINGS SEE:

"General technical information" page VIII

For outline drawing see page 10

**40.31/51**



- 1 CO 12 A on PCB, 10 A with socket
- 3.5 mm pin pitch (40.31), 5.0 mm pin pitch (40.51)
- PCB or 95 Series socket mount

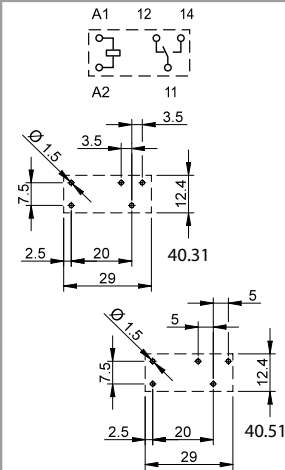

Copper side view  
Pin length 3.5 mm for PCB only  
Pin length 5.2 mm for PCB or sockets  
See ordering information

**40.52**



- 2 CO 8 A
- 5.0 mm pin pitch
- PCB or 95 Series socket mount

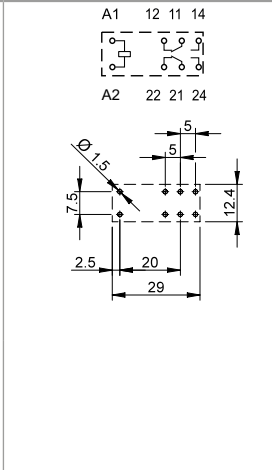

Copper side view  
Pin length 5.2 mm for PCB or sockets  
See ordering information

**40.61**



- 1 CO 16 A
- 5.0 mm pin pitch
- PCB or 95 Series socket mount

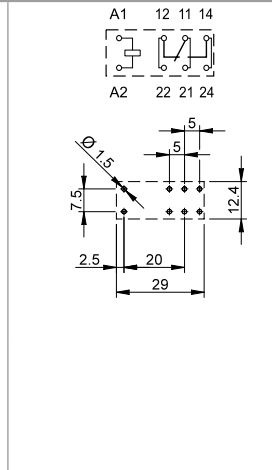

Copper side view  
Pin length 3.5 mm for PCB only  
Pin length 5.2 mm for PCB or sockets  
See ordering information

**Contact specification**

Contact configuration		1 CO (SPDT)	2 CO (DPDT)	1 CO (SPDT)
Rated current/Maximum peak current	A	12*/20	8/15**	16/30**
Rated voltage/Maximum switching voltage	V AC	250/400	250/400	250/400
Rated load AC1	VA	3000	2000	4000
Rated load AC15 (230 V AC)	VA	1000	750	1000
Single phase motor rating (230 V AC)	kW	0.55	0.37	0.55
Breaking capacity DC1: 24/110/220 V	A	12/0.6/0.25	8/0.6/0.25	16/0.6/0.25
Minimum switching load	mW (V/mA)	300 (5/5)	300 (5/5)	500 (10/5)
Standard contact material		AgNi	AgNi	AgNi

**Coil specification**

Nominal voltage (U <sub>N</sub> )	V AC (50/60 Hz)	6 - 12 - 24 - 48 - 60 - 110 - 120 - 230 - 240		
	V DC	5 - 6 - 7 - 9 - 12 - 14 - 18 - 21 - 24 - 28 - 36 - 48 - 60 - 90 - 110 - 125		
Rated power AC/DC/sensitive DC	VA (50 Hz)/W/W	1.2/0.65/0.5	1.2/0.65/0.5	1.2/0.65/0.5
Operating range	AC	(0.8...1.1)U <sub>N</sub>	(0.8...1.1)U <sub>N</sub>	(0.8...1.1)U <sub>N</sub>
	DC/sensitive DC	(0.73...1.5)U <sub>N</sub> /(0.73...1.5)U <sub>N</sub>	(0.73...1.5)U <sub>N</sub> /(0.73...1.5)U <sub>N</sub>	(0.73...1.5)U <sub>N</sub> /(0.8...1.5)U <sub>N</sub>
Holding voltage	AC/DC	0.8 U <sub>N</sub> /0.4 U <sub>N</sub>	0.8 U <sub>N</sub> /0.4 U <sub>N</sub>	0.8 U <sub>N</sub> /0.4 U <sub>N</sub>
Must drop-out voltage	AC/DC	0.2 U <sub>N</sub> /0.1 U <sub>N</sub>	0.2 U <sub>N</sub> /0.1 U <sub>N</sub>	0.2 U <sub>N</sub> /0.1 U <sub>N</sub>

**Technical data**

Mechanical life	cycles	10 · 10 <sup>6</sup>	10 · 10 <sup>6</sup>	10 · 10 <sup>6</sup>
Electrical life at rated load AC1	cycles	200 · 10 <sup>3</sup>	100 · 10 <sup>3</sup>	100 · 10 <sup>3</sup>
Operate/release time	ms	7/3 (10/3 sensitive)	7/3 (12/4 sensitive)	7/3 (10/3 sensitive)
Insulation between coil and contacts (1.2/50 µs)	kV	6 (8 mm)	6 (8 mm)	6 (8 mm)
Dielectric strength between open contacts	V AC	1000	1000	1000
Ambient temperature range	°C	-40...+85	-40...+85	-40...+85
Environmental protection		RT II***	RT II***	RT II***

**Approvals (according to type)**



\*\*\* See general technical information "Guidelines for automatic flow solder processes" page II.

**Power relays 1 and 2 pole for direct PCB or socket mount**

**Type 40.62**

- 2 CO 10A (5.0 mm pin pitch)
- DC coils (650 mW or 500 mW) and AC coils
- Meets EN 60335-1 glow wire requirements

**Type 40.xx.6**

- Bistable versions of the types 40.31, 40.51, 40.52 and 40.61
- Bistable (single coil)

- Cadmium-free contact material available
- 8 mm Creepage and Clearance, 6 kV (1.2/50µs) between coil and contact
- 95 series sockets for PCB or 35 mm rail mounting (EN 60715) with Screw, Screwless or Push-in terminals
- Environmental protection:  
RT II - flux proof (Standard)  
RT III - wash tight (Option)

\* With the AgSnO<sub>2</sub> material the maximum peak current on normally open contact is 60 A - 5 ms (for 40.62)

FOR UL RATINGS SEE:

"General technical information" page VIII

For outline drawing see page 10

**Contact specification**

Contact configuration		2 CO (DPDT)
Rated current/Maximum peak current	A	10/20*
Rated voltage/Maximum switching voltage	V AC	250/400
Rated load AC1	VA	2500
Rated load AC15 (230 V AC)	VA	750
Single phase motor rating (230 V AC)	kW	0.37
Breaking capacity DC1: 24/110/220 V	A	10/0.6/0.25
Minimum switching load	mW (V/mA)	300 (5/5)
Standard contact material		AgNi

**Coil specification**

Nominal voltage (U <sub>N</sub> )	V AC (50/60 Hz)	110 - 120 - 230 - 240
	V DC	5 - 6 - 7 - 9 - 12 - 14 - 18 - 21 - 24 - 28 - 48 - 60 - 110 - 125
Rated power AC/DC/sens. DC	VA (50 Hz)/W/W	1.2/0.65/0.5
Operating range	AC	(0.8...1.1)U <sub>N</sub>
	DC/sens. DC	(0.73...1.5)U <sub>N</sub> / (0.73..1.5) U <sub>N</sub>
Holding voltage	AC/DC	0.8/0.4 U <sub>N</sub>
Must drop-out voltage	AC/DC	0.2/0.1 U <sub>N</sub>

**Technical data**

Mechanical life	cycles	10 · 10 <sup>6</sup>
Electrical life at rated load AC1	cycles	100 · 10 <sup>3</sup>
Operate/release time	ms	7/3 (12/4 sensitive)
Insulation between coil and contacts (1.2/50 µs)	kV	6 (8 mm)
Dielectric strength between open contacts	V AC	1000
Ambient temperature range	°C	-40...+85
Environmental protection		RT II

**Approvals** (according to type)

**NEW 40.62**

- 2 CO 10 A
- 5.0 mm pin pitch
- PCB or 95 Series sockets mount

**40.xx.6**

- Bistable (single coil)
- 3.5 or 5.0 mm pin pitch
- PCB or 95 Series socket mount

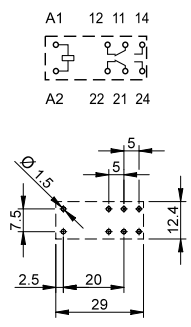

Copper side view  
Pin length 5.2 mm for PCB or sockets

Bistable version (1 coil) types:

- 40.31.6...
- 40.51.6...
- 40.52.6...
- 40.61.6...

For wiring diagrams see page 10

Pin length 5.2 mm for PCB or sockets

\*\* See general technical information "Guidelines for automatic flow solder processes" page II.



## Ordering information

Example: 40 series PCB relay, 2 CO, 230 V AC coil.

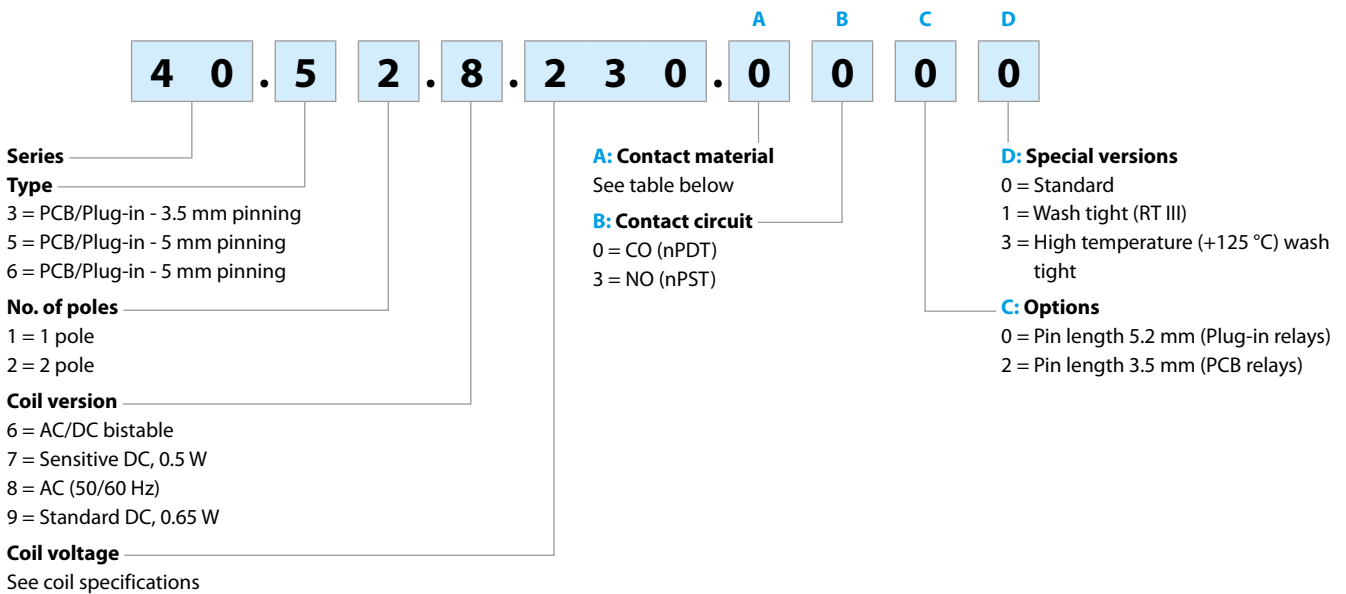

**Selecting features and options: only combinations in the same row are possible.**

Preferred selections for best availability are shown in **bold**.

Terminal pin	Type	Coil version	A	B	C	D
PCB relay, pin length 3.5 mm	40.31/51	Standard DC/sensitive DC	<b>1</b> (AgNi)	<b>0</b> - 3	<b>2</b>	<b>0</b> - 1
	40.61	Standard DC/sensitive DC	1 (AgNi) - <b>4</b> (AgSnO <sub>2</sub> )	<b>0</b> - 3	<b>2</b>	<b>0</b> - 1
PCB/Plug-in relay pin length 5.2 mm	40.31/51	AC/sensitive DC	<b>0</b> (AgNi) - 4 (AgSnO <sub>2</sub> ) - 5 (AgNi+Au)	<b>0</b> - 3	<b>0</b>	<b>0</b> - 1
	40.31/51	Standard DC	<b>0</b> (AgNi) - 4 (AgSnO <sub>2</sub> ) - 5 (AgNi+Au)	<b>0</b> - 3	<b>0</b>	<b>0</b> - 1 - 3
	40.52	AC/sensitive DC	<b>0</b> (AgNi) - 4 (AgSnO <sub>2</sub> ) - 5 (AgNi+Au)	<b>0</b> - 3	<b>0</b>	<b>0</b> - 1
	40.52	Standard DC	<b>0</b> (AgNi) - 4 (AgSnO <sub>2</sub> ) - 5 (AgNi+Au)	<b>0</b> - 3	<b>0</b>	<b>0</b> - 1 - 3
	40.61	AC/sensitive DC	<b>1</b> (AgNi) - 4 (AgSnO <sub>2</sub> )	<b>0</b> - 3	<b>0</b>	<b>0</b> - 1
	40.61	Standard DC	<b>1</b> (AgNi) - 4 (AgSnO <sub>2</sub> )	<b>0</b> - 3	<b>0</b>	<b>0</b> - 1 - 3
	40.62	AC/DC/sensitive DC	<b>0</b> (AgNi) - 4 (AgSnO <sub>2</sub> )	<b>0</b>	<b>0</b>	<b>0</b> - 1
	40.31/51/52	Bistable	<b>0</b> (AgNi)	<b>0</b>	<b>0</b>	<b>0</b>
	40.61	Bistable	1 (AgNi) - <b>4</b> (AgSnO <sub>2</sub> )	<b>0</b>	<b>0</b>	<b>0</b>

## Technical data

### Insulation according to EN 61810-1

		1 pole		2 pole	
Nominal voltage of supply system	V AC	230/400		230/400	
Rated insulation voltage	V AC	250	400	250	400
Pollution degree		3	2	3	2
<b>Insulation between coil and contact set</b>					
Type of insulation		Reinforced (8 mm)		Reinforced (8 mm)	
Overvoltage category		III		III	
Rated impulse voltage	kV (1.2/50 μs)	6		6	
Dielectric strength	V AC	4000		4000	
<b>Insulation between adjacent contacts (40.52)</b>					
Type of insulation		—		Basic	
Overvoltage category		—		II	
Rated impulse voltage	kV (1.2/50 μs)	—		2.5	
Dielectric strength	V AC	—		2000	
<b>Insulation between adjacent contacts (40.52 + 40.62)</b>					
Type of insulation		—		Basic	
Overvoltage category		—		III	
Rated impulse voltage	kV (1.2/50 μs)	—		4	
Dielectric strength	V AC	—		2500	
<b>Insulation between open contacts</b>					
Type of disconnection		Micro-disconnection		Micro-disconnection	
Dielectric strength	V AC/kV (1.2/50 μs)	1000/1.5		1000/1.5	
<b>Insulation between coil terminals</b>					
Rated impulse voltage (surge) differential mode (according to EN 61000-4-5)	kV (1.2/50 μs)	2			
<b>Other data</b>					
Bounce time: NO/NC	ms	2/5			
Vibration resistance (10...150)Hz: NO/NC	g	20/5 (1 changeover)		15/4 (2 changeover)	
Shock resistance NO/NC	g	20/13 (1 changeover)		20/12 (2 changeover)	
Power lost to the environment	without contact current	W	0.65		
	with rated current	W	1.2 (40.31/51)		2 (40.61/52/62)
Recommended distance between relays mounted on PCB	mm	≥ 5			

## Contact specification

**F 40.1 - Electrical life (AC) v contact current**  
Types 40.31/51/61

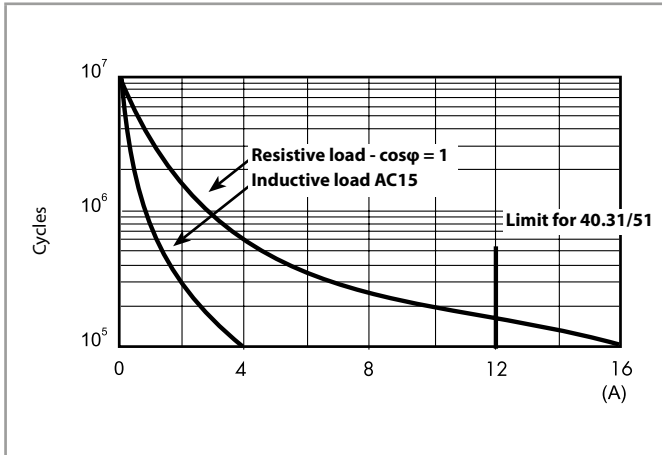

**F 40.2 - Electrical life (AC) v contact current**  
Type 40.52

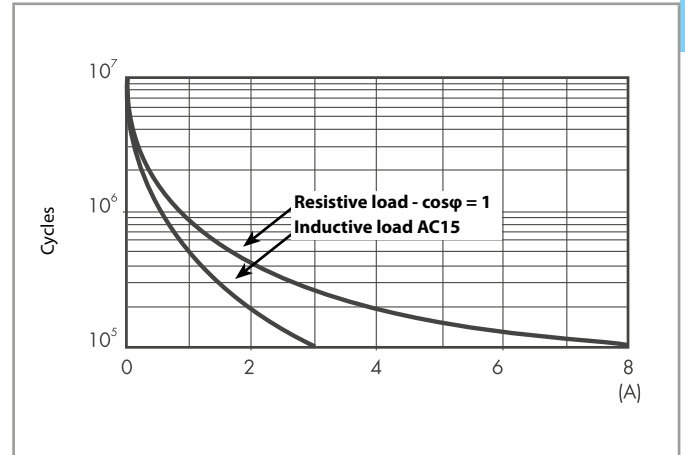

**F 40.6 - Electrical life (AC) v contact current**  
Type 40.62

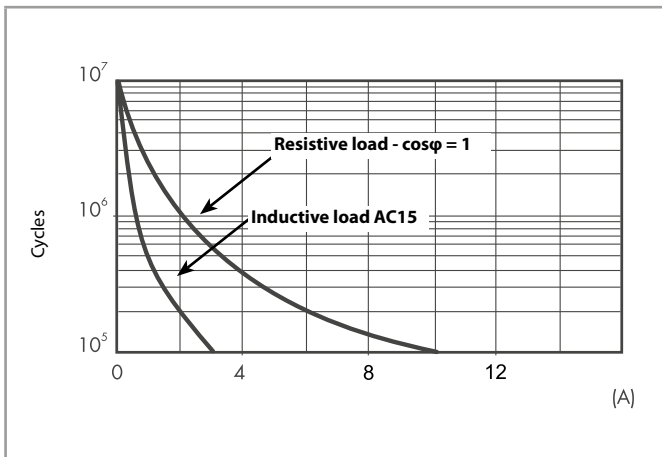

## Contact specification

**H 40.1 - Maximum DC1 breaking capacity**  
Types 40.31/51/52/61

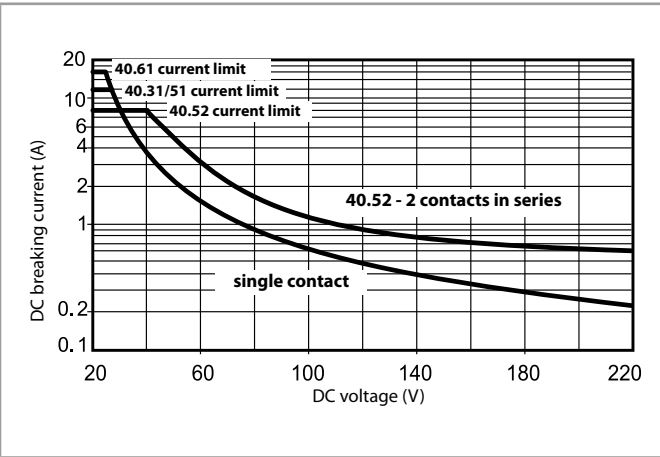

**H 40.6 - Maximum DC1 breaking capacity**  
Type 40.62

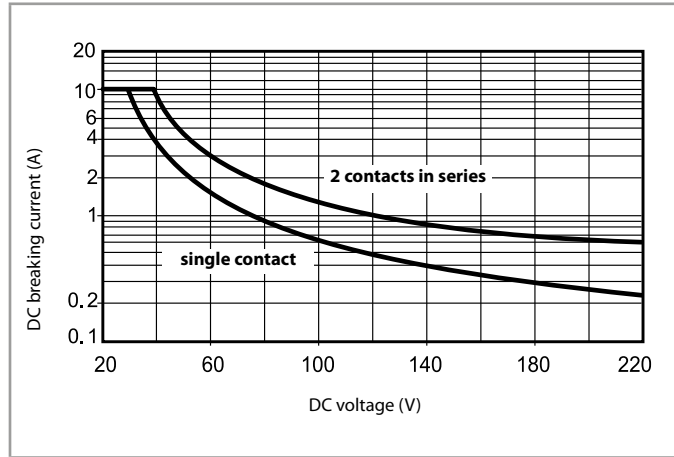

- When switching a resistive load (DC1) having voltage and current values under the curve, an electrical life of  $\geq 100 \cdot 10^3$  can be expected.
  - In the case of DC13 loads, the connection of a diode in parallel with the load will permit a similar electrical life as for a DC1 load.
- Note: the release time for the load will be increased.



## Coil specifications

**DC coil data - 0.65 W standard** (types 40.31/51/52/61/62)

Nominal voltage $U_N$ V	Coil code	Operating range		Resistance R $\Omega$	Rated coil consumption I at $U_N$ mA
		$U_{min}$ V	$U_{max}$ V		
5	9.005	3.65	7.5	38	130
6	9.006	4.4	9	55	109
7	9.007	5.1	10.5	75	94
9	9.009	6.6	13.5	125	72
12	9.012	8.8	18	220	55
14	9.014	10.2	21	300	47
18	9.018	13.1	27	500	36
21	9.021	15.3	31.5	700	30
24	9.024	17.5	36	900	27
28	9.028	20.5	42	1200	23
36	9.036	26.3	54	2000	18
48	9.048	35	72	3500	14
60	9.060	43.8	90	5500	11
90	9.090	65.7	135	12500	7.2
110	9.110	80.3	165	18000	6.2
125	9.125	91.2	188	23500	5.3

**DC coil data - 0.5 W sensitive** (types 40.31/51/52/61/62)

Nominal voltage $U_N$ V	Coil code	Operating range		Resistance R $\Omega$	Rated coil consumption I at $U_N$ mA
		$U_{min}^*$ V	$U_{max}$ V		
5	7.005	3.7	7.5	50	100
6	7.006	4.4	9	75	80
7	7.007	5.1	10.5	100	70
9	7.009	6.6	13.5	160	56
12	7.012	8.8	18	288	42
14	7.014	10.2	21	400	35
18	7.018	13.2	27	650	27.7
21	7.021	15.4	31.5	900	23.4
24	7.024	17.5	36	1150	21
28	7.028	20.5	42	1600	17.5
36	7.036	26.3	54	2600	13.8
48	7.048	35	72	4800	10
60	7.060	43.8	90	7200	8.4
90	7.090	65.7	135	16200	5.6
110	7.110	80.3	165	23500	4.7
125	7.125	91.2	188	32000	3.9

\*  $U_{min} = 0.8 U_N$  for 40.61

**AC coil data** (types 40.31/51/52/61/62)

Nominal voltage $U_N$ V	Coil code	Operating range		Resistance R $\Omega$	Rated coil consumption I at $U_N$ (50 Hz) mA
		$U_{min}$ V	$U_{max}$ V		
6	8.006	4.8	6.6	21	168
12	8.012	9.6	13.2	80	90
24	8.024	19.2	26.4	320	45
48	8.048	38.4	52.8	1350	21
60	8.060	48	66	2100	16.8
110	8.110	88	121	6900	9.4
120	8.120	96	132	9000	8.4
230	8.230	184	253	28000	5
240	8.240	192	264	31500	4.1

**AC/DC coil data - bistable** (types 40.31/51/52/61)

Nominal voltage $U_N$ V	Coil code	Operating range		Resistance R $\Omega$	Rated coil consumption I at $U_N$ mA	DC: Release resistance** $R_{DC}$ $\Omega$
		$U_{min}$ V	$U_{max}$ V			
5	6.005	4	5.5	23	215	37
6	6.006	4.8	6.6	33	165	62
12	6.012	9.6	13.2	130	83	220
24	6.024	19.2	26.4	520	40	910
48	6.048	38.4	52.8	2100	21	3600
110	6.110	88	121	11000	10	16500

\*\*  $R_{DC}$  = Resistance in DC,  $R_{AC} = 1.3 \times R_{DC}$  1 W

## Coil specifications

### R 40 - DC coil operating range v ambient temperature

Standard coil

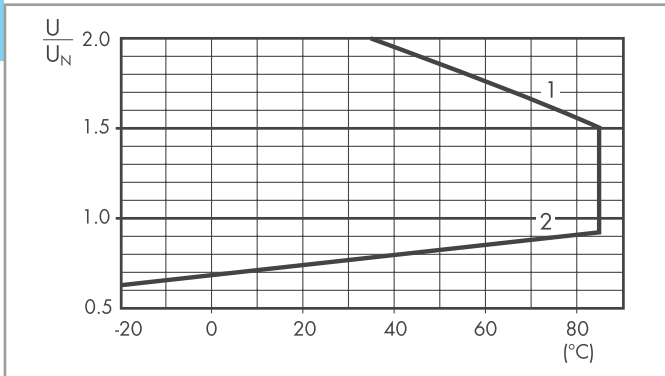

### R 40 - DC coil operating range v ambient temperature

Sensitive coil, types 40.31/51/52/61/62

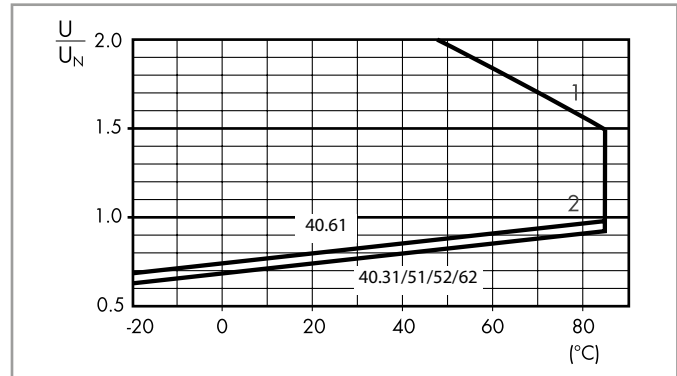

### R 40 - AC coil operating range v ambient temperature

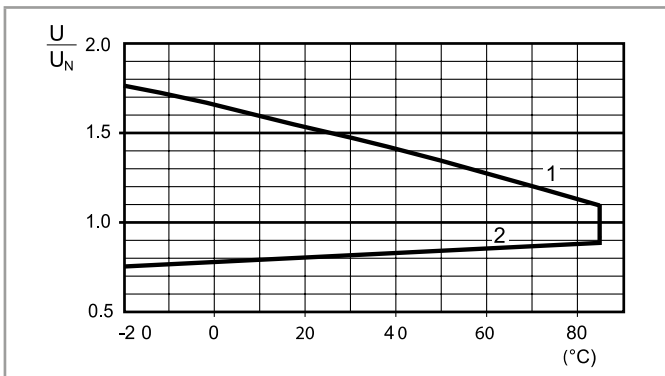

1 - Max. permitted coil voltage.

2 - Min. pick-up voltage with coil at ambient temperature.

### Wiring diagram for 40 series bistable coil version

#### AC Operation

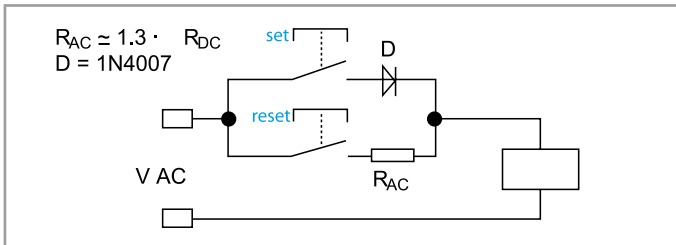

#### DC Operation

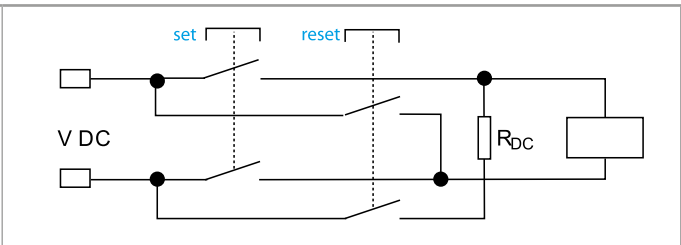

On momentary closure of the SET switch the relay is magnetised through the diode and the relay contacts transfer to the set position and remain in this position.

On momentary closure of the RESET switch the relay is demagnetised through limiting resistor ( $R_{AC}$ ) and the contacts return to the reset position.

On momentary closure of the SET switch the relay is magnetised and the relay contacts transfer to the set position and remain in this position.

On momentary closure of the RESET switch the relay is demagnetised through limiting resistor ( $R_{DC}$ ) and the contacts return to the reset position.

**Notes:** The minimum SET or RESET impulse time is 20 ms. The maximum time can be continuous. In practice, always ensure that the SET and RESET contacts cannot be operated simultaneously.

## Outline drawings

Types 40.31/51/52/61/62

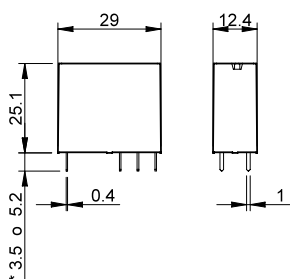

\* (3.5 or 5.2 mm) see ordering code



95.P5

See page 12

Module	Socket	Relay	Description	Mounting	Accessories
99.02	95.P3	40.31	<b>Push-in terminal sockets</b> - For fast cable connection - Top terminals - Contacts - Bottom terminals - Coil	Panel or 35 mm rail (EN 60715) mount	- Coil indication and EMC suppression modules - Jumper link - Timer modules - Plastic retaining and release clip
	95.P5	40.51 40.52 40.61 40.62			

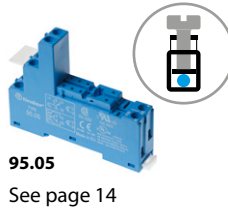

95.05

See page 14

Module	Socket	Relay	Description	Mounting	Accessories
99.02	95.03	40.31	<b>Box clamp socket</b> - Top terminals - Contacts - Bottom terminals - Coil	Panel or 35 mm rail (EN 60715) mount	- Coil indication and EMC suppression modules - Jumper link - Timer modules - Plastic retaining and release clip
	95.05	40.51 40.52 40.61 40.62			

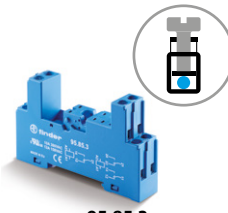

95.85.3

See page 15

Module	Socket	Relay	Description	Mounting	Accessories
99.80	95.83.3	40.31	<b>Box clamp socket</b> - Top terminals - NO and COM Contacts - Bottom terminals - Coil and NC Contacts	Panel or 35 mm rail (EN 60715) mount	- Coil indication and EMC suppression modules - Jumper link - Plastic retaining and release clip
	95.85.3	40.51 40.52 40.61 40.62			

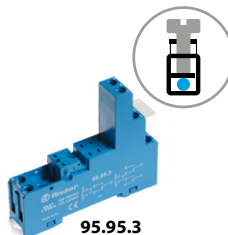

95.95.3

See page 16

Module	Socket	Relay	Description	Mounting	Accessories
99.80	95.93.3	40.31	<b>Box clamp socket</b> - Top terminals - Contacts - Bottom terminals - Coil	Panel or 35 mm rail (EN 60715) mount	- Coil indication and EMC suppression modules - Jumper link - Plastic retaining and release clip
	95.95.3	40.51 40.52 40.61 40.62			

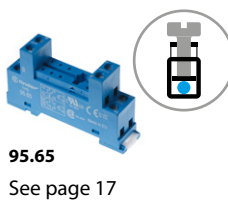

95.65

See page 17

Module	Socket	Relay	Description	Mounting	Accessories
99.01	95.63	40.31	<b>Box clamp socket</b> - Top terminals - Contacts - Bottom terminals - Coil	Panel or 35 mm rail (EN 60715) mount	- Metal retaining clip
	95.65	40.51 40.52 40.61 40.62			



95.13.2

See page 18

Module	Socket	Relay	Description	Mounting	Accessories
—	95.13.2	40.31	<b>PCB socket</b>	PCB mounting	- Metal retaining clip - Plastic retaining clip
—	95.15.2	40.51			
		40.52			
		40.61 40.62			

A

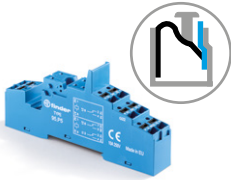

**95.P5**  
Approvals  
(according to type):



**95.91.3**

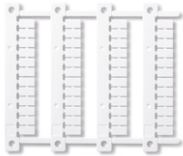

**060.48**

<b>Push-in terminals socket</b> panel or 35 mm rail mount	<b>95.P3</b>	<b>95.P5</b>
For relay type	40.31	40.51, 40.52, 40.61, 40.62
<b>Accessories</b>		
Metal retaining clip		095.71
Plastic retaining and release clip (supplied with socket - packaging code SPA)		095.91.3
8-way jumper link		097.58
2-way jumper link (12.5 mm pitch)		097.52
2-way jumper link (4.6 mm pitch)		097.42
Marker tag holder (for tags 060.48 type)		097.00
Identification tag		095.00.4
Modules (see table below)		99.02
Timer modules (see table below)		86.30
Sheet of marker tags for plastic retaining and release clip 095.91.3 and for marker tag holder 097.00, 48 tags, 6 x 12 mm, for CEMBRE thermal transfert printer		060.48
<b>Technical data</b>		
Rated values	10 A - 250 V*	
Dielectric strength between coil and contacts (1.2/50 μs)	6 kV	
Protection category	IP 20	
Ambient temperature	°C -40...+70 (see diagram L95)	
Wire strip length	mm 10	
Min. wire size for 95.P3 and 95.P5 sockets	solid wire	stranded wire
	mm <sup>2</sup> 0.5	0.5
	AWG 21	21
Max. wire size for 95.P3 and 95.P5 sockets	solid wire	stranded wire
	mm <sup>2</sup> 2 x 1.5 / 1 x 2.5	2 x 1.5 / 1 x 2.5
	AWG 2 x 16 / 1 x 14	2 x 16 / 1 x 14

\* For currents > 10 A, contact terminals must be connected in parallel (21 with 11, 24 with 14, 22 with 12).  
With the relay 40.51 the change-over contact will be 21-12-14.

**L 95 - Total socket current v ambient temperature**

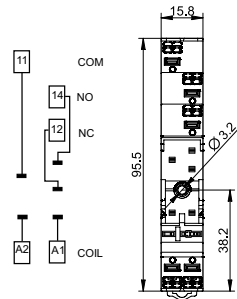
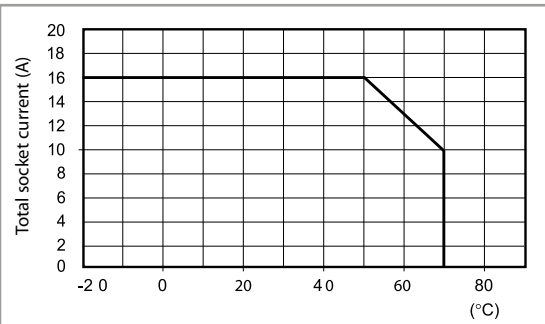

95.P3

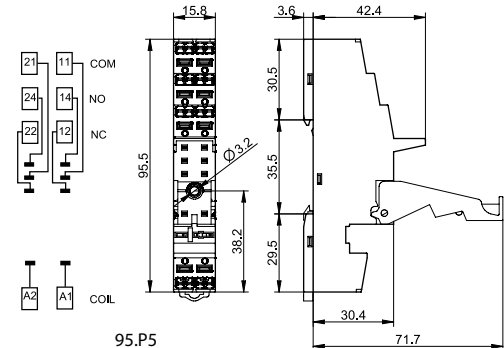

95.P5



**097.58**

<b>8-way jumper link</b> for 95.P3 and 95.P5 sockets	<b>097.58</b>
Rated values	10 A - 250 V

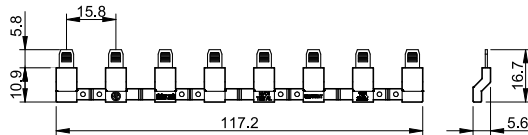

**097.52**

<b>2-way jumper link</b> for 95.P3 and 95.P5 sockets	<b>097.52</b>
Rated values	10 A - 250 V

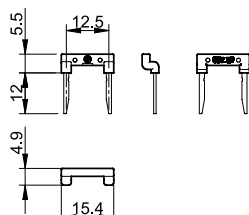



097.42

<b>2-way jumper link</b> for 95.P3 and 95.P5 sockets	097.42
Rated values	10 A - 250 V

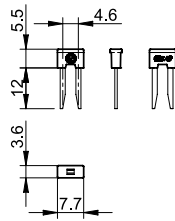

097.00

<b>Marker tag holder</b> for 95.P3 and 95.P5 sockets	097.00
--	--------

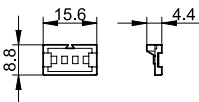

86.30

<b>86 series timer modules</b>	
(12...24)V AC/DC; Bi-function: AI, DI; (0.05 s...100 h)	86.30.0.024.0000
(110...125)V AC; Bi-function: AI, DI; (0.05 s...100 h)	86.30.8.120.0000
(230...240)V AC; Bi-function: AI, DI; (0.05 s...100 h)	86.30.8.240.0000

Approvals (according to type):



99.02

Approvals  
(according to type):



DC Modules with  
non-standard polarity  
(+A2) on request.

<b>99.02 coil indication and EMC suppression modules</b> for 95.P3 and 95.P5 sockets		
Diode (+A1, standard polarity)	(6...220)V DC	99.02.3.000.00
LED	(6...24)V DC/AC	99.02.0.024.59
LED	(28...60)V DC/AC	99.02.0.060.59
LED	(110...240)V DC/AC	99.02.0.230.59
LED + Diode (+A1, standard polarity)	(6...24)V DC	99.02.9.024.99
LED + Diode (+A1, standard polarity)	(28...60)V DC	99.02.9.060.99
LED + Diode (+A1, standard polarity)	(110...220)V DC	99.02.9.220.99
LED + Varistor	(6...24)V DC/AC	99.02.0.024.98
LED + Varistor	(28...60)V DC/AC	99.02.0.060.98
LED + Varistor	(110...240)V DC/AC	99.02.0.230.98
RC circuit	(6...24)V DC/AC	99.02.0.024.09
RC circuit	(28...60)V DC/AC	99.02.0.060.09
RC circuit	(110...240)V DC/AC	99.02.0.230.09
Residual current by-pass*	(110...240)V AC	99.02.8.230.07

\* Additional 0.9 W power dissipation

A

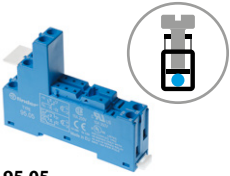

95.05  
Approvals  
(according to type):



095.01

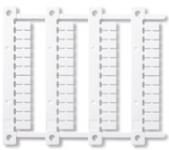

060.48

<b>Box clamp socket</b> panel or 35 mm rail mount	<b>95.03 (blue)</b>	<b>95.03.0 (black)</b>	<b>95.05 (blue)</b>	<b>95.05.0 (black)</b>
For relay type	40.31		40.51, 40.52, 40.61, 40.62	
<b>Accessories</b>				
Metal retaining clip	095.71			
Plastic retaining and release clip (supplied with socket - packaging code SPA)	095.01	095.01.0	095.01	095.01.0
8-way jumper link	095.18	095.18.0	095.18	095.18.0
Marker tag holder (for tags 060.48 type)	097.00			
Identification tag	095.00.4			
Modules (see table below)	99.02			
Timer modules (see table below)	86.30			
Sheet of marker tags for plastic retaining and release clip 095.01 and for marker tag holder 097.00, 48 tags, 6 x 12 mm, for CEMBRE thermal transfer printers	060.48			
<b>Technical data</b>				
Rated values	10 A - 250 V*			
Dielectric strength between coil and contacts (1.2/50 μs)	6 kV			
Protection category	IP 20			
Ambient temperature	°C -40...+70 (see diagram L95)			
⊕ Screw torque	Nm 0.5			
Wire strip length	mm 8			
Max. wire size for 95.03 and 95.05 sockets	solid wire		stranded wire	
	mm <sup>2</sup> 1 x 6 / 2 x 2.5		1 x 4 / 2 x 2.5	
	AWG 1 x 10 / 2 x 14		1 x 12 / 2 x 14	

\* For currents > 10 A, contact terminals must be connected in parallel (21 with 11, 24 with 14, 22 with 12).  
With the relay 40.51 the change-over contact will be 21-12-14.

**L 95 - Total socket current v ambient temperature**

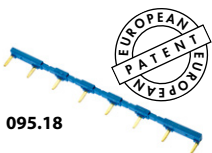
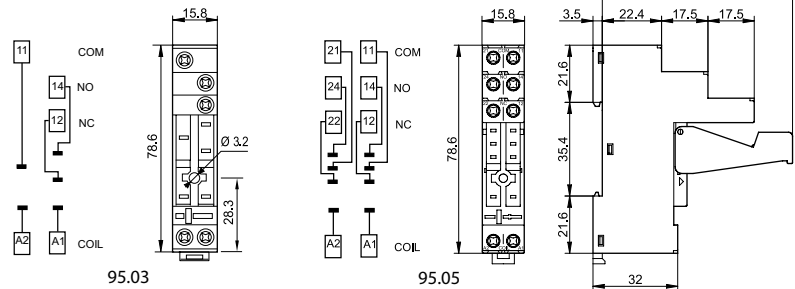
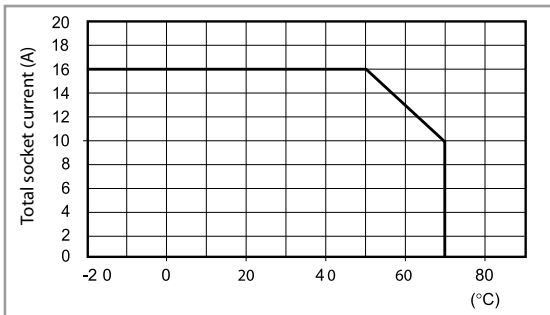

095.18

<b>8-way jumper link</b> for 95.03 and 95.05 sockets	<b>095.18 (blue)</b>	<b>095.18.0 (black)</b>
Rated values	10 A - 250 V	

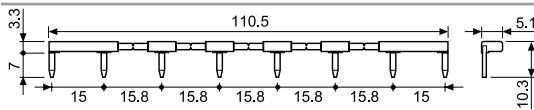

86.30

<b>86 series timer modules</b>		
(12...24)V AC/DC; Bi-function: AI, DI; (0.05 s...100 h)	86.30.0.024.0000	
(110...125)V AC; Bi-function: AI, DI; (0.05 s...100 h)	86.30.8.120.0000	
(230...240)V AC; Bi-function: AI, DI; (0.05 s...100 h)	86.30.8.240.0000	

Approvals (according to type):



99.02

Approvals  
(according to type):



DC Modules with non-standard polarity (+A2) on request.

<b>99.02 coil indication and EMC suppression modules</b> for 95.03 and 95.05 sockets		
Diode (+A1, standard polarity)	(6...220)V DC	99.02.3.000.00
LED	(6...24)V DC/AC	99.02.0.024.59
LED	(28...60)V DC/AC	99.02.0.060.59
LED	(110...240)V DC/AC	99.02.0.230.59
LED + Diode (+A1, standard polarity)	(6...24)V DC	99.02.9.024.99
LED + Diode (+A1, standard polarity)	(28...60)V DC	99.02.9.060.99
LED + Diode (+A1, standard polarity)	(110...220)V DC	99.02.9.220.99
LED + Varistor	(6...24)V DC/AC	99.02.0.024.98
LED + Varistor	(28...60)V DC/AC	99.02.0.060.98
LED + Varistor	(110...240)V DC/AC	99.02.0.230.98
RC circuit	(6...24)V DC/AC	99.02.0.024.09
RC circuit	(28...60)V DC/AC	99.02.0.060.09
RC circuit	(110...240)V DC/AC	99.02.0.230.09
Residual current by-pass*	(110...240)V AC	99.02.8.230.07

\* Additional 0.9 W power dissipation

A

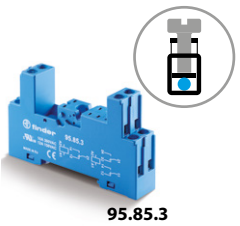

95.85.3

Approvals  
(according to type):



95.91.3



060.48

Box clamp socket panel or 35 mm rail mount	95.83.3 (blue)	95.83.30 (black)	95.85.3 (blue)	95.85.30 (black)
For relay type	40.31		40.51, 40.52, 40.61, 40.62	
<b>Accessories</b>				
Metal retaining clip	095.71			
Plastic retaining and release clip (supplied with socket - packaging code SPA)	095.91.3	095.91.30	095.91.3	095.91.30
8-way jumper link	095.08	095.08.0	095.08	095.08.0
Identification tag	095.00.4			
Modules (see table below)	99.80			
Marker tag holder	097.00			
Sheet of marker tags for plastic retaining and release clip 095.91.3, 48 tags, 6 x 12 mm, for CEMBRE thermal transfert printer	060.48			
<b>Technical data</b>				
Rated values	10 A - 250 V*			
Dielectric strength between coil and contacts (1.2/50 μs)	6 kV		2 kV	
Protection category	IP 20			
Ambient temperature	°C -40...+70 (see diagram L95)			
Screw torque	Nm	0.5		
Wire strip length	mm 7			
Max. wire size for 95.83.3 and 95.85.3 sockets	solid wire		stranded wire	
	mm <sup>2</sup>	1 x 6 / 2 x 2.5		1 x 4 / 2 x 2.5
	AWG	1 x 10 / 2 x 14		1 x 12 / 2 x 14

\* For currents > 10 A, contact terminals must be connected in parallel (21 with 11, 24 with 14, 22 with 12).

With the relay 40.51 the change-over contact will be 21-12-14.

**L 95 - Total socket current v ambient temperature**

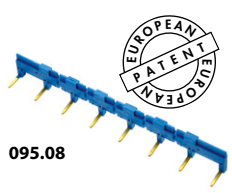
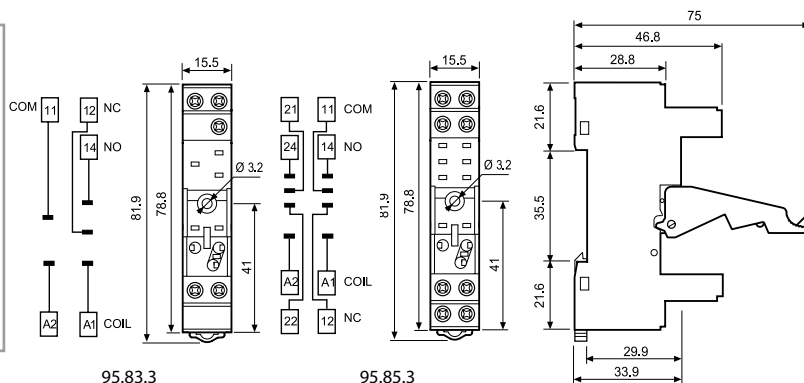
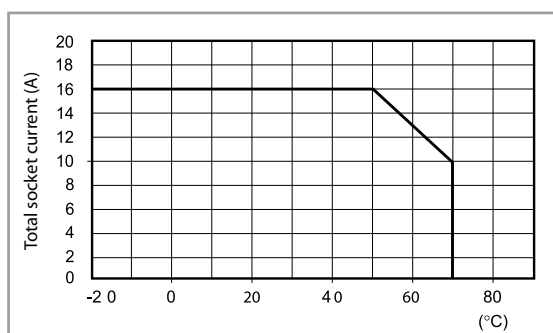

95.08

8-way jumper link for 95.83.3 and 95.85.3 sockets	095.08 (blue)	095.08.0 (black)
Rated values	10 A - 250 V	

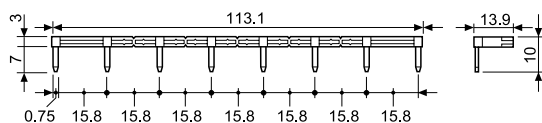

99.80

Approvals  
(according to type):



\* Modules in Black housing are available on request.

Green LED is standard. Red LED available on request.

99.80 coil indication and EMC suppression modules for 95.83.3 and 95.85.3 sockets		Blue*
Diode (+A1, standard polarity)	(6...220)V DC	99.80.3.000.00
LED	(6...24)V DC/AC	99.80.0.024.59
LED	(28...60)V DC/AC	99.80.0.060.59
LED	(110...240)V DC/AC	99.80.0.230.59
LED + Diode (+A1, standard polarity)	(6...24)V DC	99.80.9.024.99
LED + Diode (+A1, standard polarity)	(28...60)V DC	99.80.9.060.99
LED + Diode (+A1, standard polarity)	(110...220)V DC	99.80.9.220.99
LED + Varistor	(6...24)V DC/AC	99.80.0.024.98
LED + Varistor	(28...60)V DC/AC	99.80.0.060.98
LED + Varistor	(110...240)V DC/AC	99.80.0.230.98
RC circuit	(6...24)V DC/AC	99.80.0.024.09
RC circuit	(28...60)V DC/AC	99.80.0.060.09
RC circuit	(110...240)V DC/AC	99.80.0.230.09
Residual current by-pass*	(110...240)V AC	99.80.8.230.07

\* Additional 0.9 W power dissipation

A

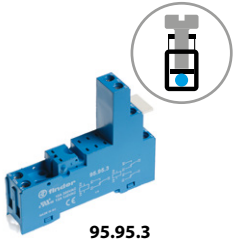

95.95.3

Approvals  
(according to type):



095.91.3

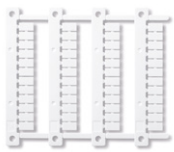

060.48

<b>Screw (Box clamp) terminal socket</b> panel or 35 mm rail mount	<b>95.93.3 (blue)</b>	<b>95.93.30 (black)</b>	<b>95.95.3 (blue)</b>	<b>95.95.30 (black)</b>
For relay type	40.31		40.51, 40.52, 40.61, 40.62	
<b>Accessories</b>				
Metal retaining clip	095.71			
Plastic retaining and release clip (supplied with socket - packaging code SPA)	095.91.3	095.91.30	095.91.3	095.91.30
8-way jumper link	095.08	095.08.0	095.08	095.08.0
Identification tag	095.00.4			
Modules (see table below)	99.80			
Sheet of marker tags for plastic retaining and release clip 095.91.3 and for marker tag holder 097.00, 48 tags, 6 x 12 mm, for CEMBRE thermal transfer printers	060.48			
<b>Technical data</b>				
Rated values	10 A - 250 V*			
Dielectric strength between coil and contacts (1.2/50 μs)	6 kV			
Protection category	IP 20			
Ambient temperature	°C -40...+70 (see diagram L95)			
Screw torque	Nm 0.5			
Wire strip length	mm 8			
Max. wire size for 95.93.3 and 95.95.3 sockets	solid wire		stranded wire	
	mm <sup>2</sup> 1 x 6 / 2 x 2.5		1 x 4 / 2 x 2.5	
	AWG 1 x 10 / 2 x 14		1 x 12 / 2 x 14	

\* For currents > 10 A, contact terminals must be connected in parallel (21 with 11, 24 with 14, 22 with 12).  
With the relay 40.51 the change-over contact will be 21-12-14.

**L 95 - Total socket current v ambient temperature**

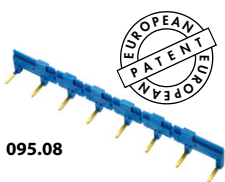
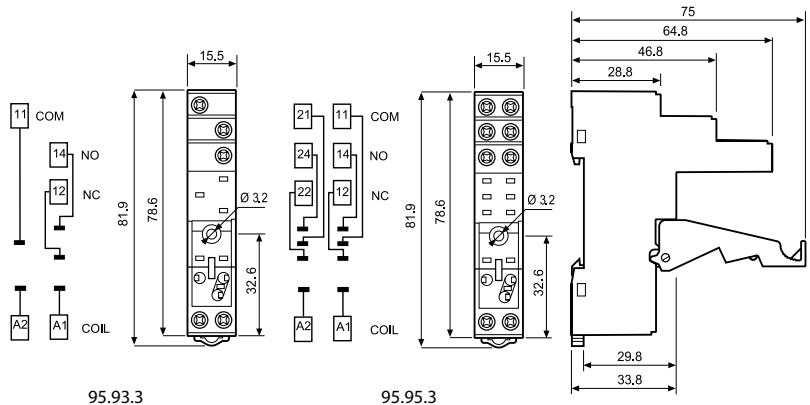
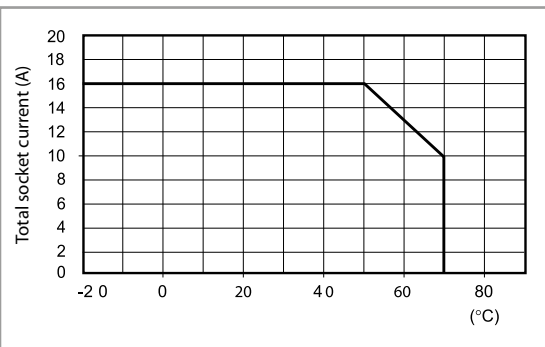

095.08

<b>8-way jumper link</b> for 95.93.3 and 95.95.3 sockets	<b>095.08 (blue)</b>	<b>095.08.0 (black)</b>
Rated values	10 A - 250 V	

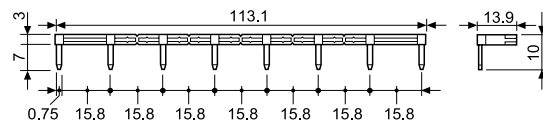

99.80  
Approvals  
(according to type):



\* Modules in Black housing are available on request.

Green LED is standard. Red LED available on request.

<b>99.80 coil indication and EMC suppression modules</b> for 95.93.3 and 95.95.3 sockets		<b>Blue*</b>
Diode (+A1, standard polarity)	(6...220)V DC	99.80.3.000.00
LED	(6...24)V DC/AC	99.80.0.024.59
LED	(28...60)V DC/AC	99.80.0.060.59
LED	(110...240)V DC/AC	99.80.0.230.59
LED + Diode (+A1, standard polarity)	(6...24)V DC	99.80.9.024.99
LED + Diode (+A1, standard polarity)	(28...60)V DC	99.80.9.060.99
LED + Diode (+A1, standard polarity)	(110...220)V DC	99.80.9.220.99
LED + Varistor	(6...24)V DC/AC	99.80.0.024.98
LED + Varistor	(28...60)V DC/AC	99.80.0.060.98
LED + Varistor	(110...240)V DC/AC	99.80.0.230.98
RC circuit	(6...24)V DC/AC	99.80.0.024.09
RC circuit	(28...60)V DC/AC	99.80.0.060.09
RC circuit	(110...240)V DC/AC	99.80.0.230.09
Residual current by-pass*	(110...240)V AC	99.80.8.230.07

\* Additional 0.9 W power dissipation



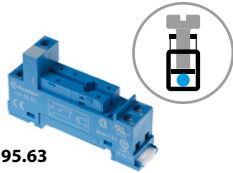

95.63

Approvals  
(according to type):



95.65

Approvals  
(according to type):



<b>Box clamp socket panel or 35 mm rail mount</b>	<b>95.63</b>	<b>95.65</b>
For relay type	40.31	40.51, 40.52, 40.61, 40.62
<b>Accessories</b>		
Metal retaining clip		095.71
8-way jumper link	095.08	095.08
Modules (see table below)	99.01	—
<b>Technical data</b>		
Rated values	10 A - 250 V*	
Dielectric strength between coil and contacts (1.2/50 μs)	6 kV	2 kV
Protection category	IP 20	
Ambient temperature	°C -40...+70 (see diagram L95)	
⊕ Screw torque	Nm 0.5	
Wire strip length	mm 7	
Max. wire size for 95.63 and 95.65 sockets	solid wire	stranded wire
	mm <sup>2</sup>	1 x 6 / 2 x 2.5
	AWG	1 x 10 / 2 x 14

\* For currents > 10 A, contact terminals must be connected in parallel (21 with 11, 24 with 14, 22 with 12).  
With the relay 40.51 the change-over contact will be 21-12-14.

**L 95 - Total socket current v ambient temperature**

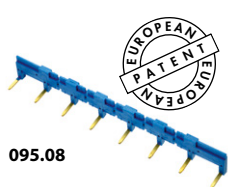
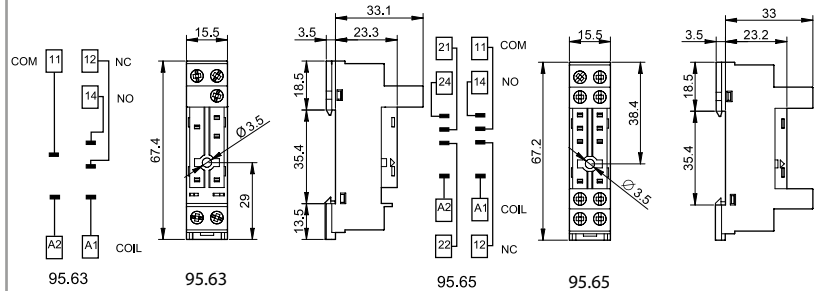
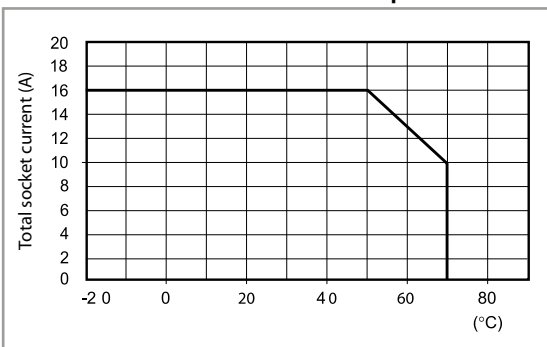

095.08



<b>8-way jumper link for 95.63 and 95.65 sockets</b>	095.08 (blue)
Rated values	10 A - 250 V

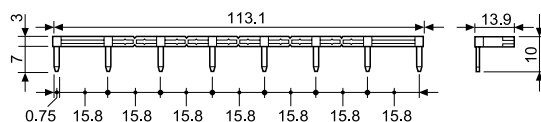

**99.01 coil indication and EMC suppression modules for type 95.63 socket**

		Blue*
Diode (+A1, standard polarity)	(6...220)V DC	99.01.3.000.00
Diode (+A2, non-standard polarity)	(6...220)V DC	99.01.2.000.00
LED	(6...24)V DC/AC	99.01.0.024.59
LED	(28...60)V DC/AC	99.01.0.060.59
LED	(110...240)V DC/AC	99.01.0.230.59
LED + Diode (+A1, standard polarity)	(6...24)V DC	99.01.9.024.99
LED + Diode (+A1, standard polarity)	(28...60)V DC	99.01.9.060.99
LED + Diode (+A1, standard polarity)	(110...220)V DC	99.01.9.220.99
LED + Diode (+A2, non-standard polarity)	(6...24)V DC	99.01.9.024.79
LED + Diode (+A2, non-standard polarity)	(28...60)V DC	99.01.9.060.79
LED + Diode (+A2, non-standard polarity)	(110...220)V DC	99.01.9.220.79
LED + Varistor	(6...24)V DC/AC	99.01.0.024.98
LED + Varistor	(28...60)V DC/AC	99.01.0.060.98
LED + Varistor	(110...240)V DC/AC	99.01.0.230.98
RC circuit	(6...24)V DC/AC	99.01.0.024.09
RC circuit	(28...60)V DC/AC	99.01.0.060.09
RC circuit	(110...240)V DC/AC	99.01.0.230.09
Residual current by-pass*	(110...240)V AC	99.01.8.230.07

\* Additional 0.9 W power dissipation



99.01

Approvals  
(according to type):



\* Modules in Black housing are available on request.

Green LED is standard.  
Red LED available on request.

A



95.13.2



95.15.2

Approvals  
(according to type):



PCB socket	95.13.2 (blue)	95.13.20 (black)	95.15.2 (blue)	95.15.20 (black)
For relay type	40.31		40.51, 40.52, 40.61, 40.62	
<b>Accessories</b>				
Metal retaining clip (supplied with socket - packaging code SMA)			095.51	
Plastic retaining clip			095.52	
<b>Technical data</b>				
Rated values	12 A - 250 V		10 A - 250 V*	
Dielectric strength between coil and contacts (1.2/50 μs)	6 kV			
Protection category	IP 20			
Ambient temperature	°C	-40...+70		

\* For currents > 10 A, contact terminals must be connected in parallel (21 with 11, 24 with 14, 22 with 12).  
With the relay 40.51 the change-over contact will be 21-12-14.

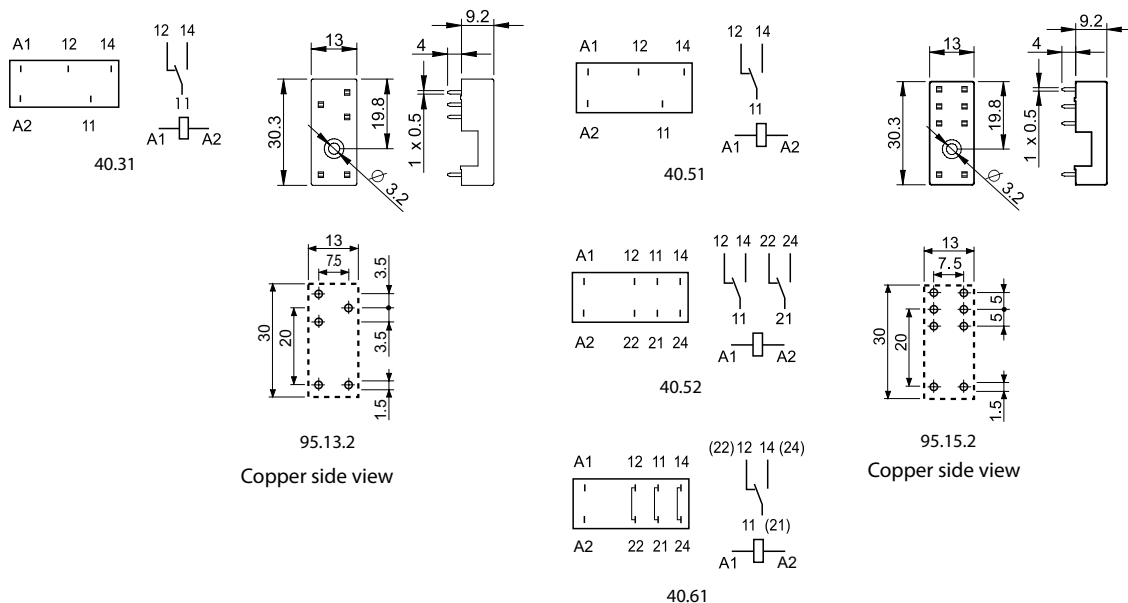

### Packaging codes

How to code and identify retaining clip and packaging options for sockets.

Example:

