

## InGaP HBT 1 Watt High IP3 AMPLIFIER, 1.7 - 2.2 GHz



### Typical Applications

A high linearity 1 watt amplifier for:

- Multi-Carrier Systems
- GSM, GPRS & EDGE
- CDMA & W-CDMA
- PHS
- Balanced or Push-Pull Configurable

### Features

- +45 dBm Output IP3 (Balanced Configuration)
- 12 dB Gain
- 48% PAE @ +30.5 dBm Pout
- +20 dBm W-CDMA Channel Power @ -45 dBc ACP
- 3x3 mm QFN SMT Package

### Functional Diagram

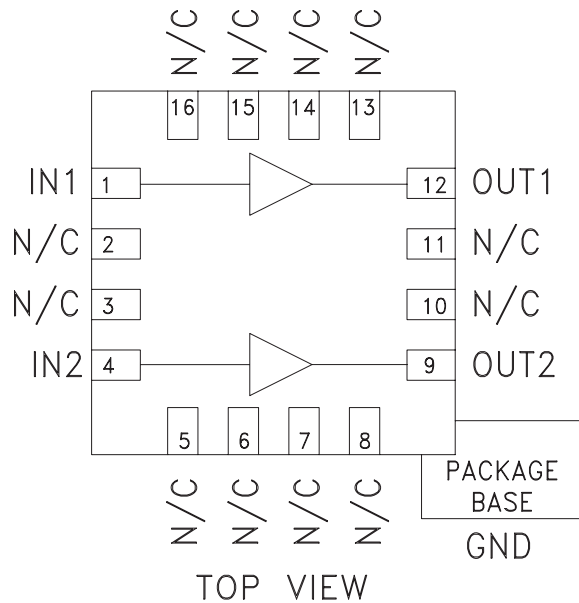

### General Description

The HMC461LP3 & HMC461LP3E are 1.7 - 2.2 GHz high output IP3 GaAs InGaP Heterojunction Bipolar Transistor (HBT) dual-channel MMIC amplifiers. The linear performance of two HMC455LP3 high IP3 drivers is offered in this single IC which can be configured in a balanced or push-pull amplifier circuit. The amplifier provides 12 dB of gain and +30.5 dBm of saturated power at 48% PAE from a single +5 Vdc supply while utilizing external baluns in a balanced configuration. The high output IP3 of +45 dBm coupled with the low VSWR of 1.2:1 make the HMC461LP3 & HMC461LP3E ideal driver amplifiers for PCS/3G wireless infrastructures. A low cost, leadless 3x3 mm QFN surface mount package (LP3) houses the dual MMIC amplifier IC. The LP3 provides an exposed base for excellent RF and thermal performance.

### Electrical Specifications\*, $T_A = +25^\circ\text{C}$ , $V_s = +5\text{V}$

Parameter	Min.	Typ.	Max.	Min.	Typ.	Max.	Units
Frequency Range	1.7 - 1.9		1.9 - 2.2				GHz
Gain	10	12.5		9	12		dB
Gain Variation Over Temperature		0.012	0.02		0.012	0.02	dB / °C
Input Return Loss		17			18		dB
Output Return Loss		20			25		dB
Output Power for 1dB Compression (P1dB)	26	29		26.5	29.5		dBm
Saturated Output Power (P <sub>sat</sub> )		29.5			30.5		dBm
Output Third Order Intercept (IP3)	41	44		42	45		dBm
Noise Figure		6.5			6		dB
Supply Current (I <sub>cc</sub> )		300			300		mA

\* Specifications and data reflect HMC461LP3 measured with external baluns in a balanced amplifier configuration optimized for 1.85 - 2.2 GHz per application circuit herein. Contact HMC Applications for 1.7 - 1.85 GHz performance optimization.

Information furnished by Analog Devices is believed to be accurate and reliable. However, no responsibility is assumed by Analog Devices for its use, nor for any infringements of patents or other rights of third parties that may result from its use. Specifications subject to change without notice. No license is granted by implication or otherwise under any patent or patent rights of Analog Devices. Trademarks and registered trademarks are the property of their respective owners.

For price, delivery, and to place orders: Analog Devices, Inc., One Technology Way, P.O. Box 9106, Norwood, MA 02062-9106  
Phone: 781-329-4700 • Order online at [www.analog.com](http://www.analog.com)  
Application Support: Phone: 1-800-ANALOG-D



**Broadband Gain & Return Loss**

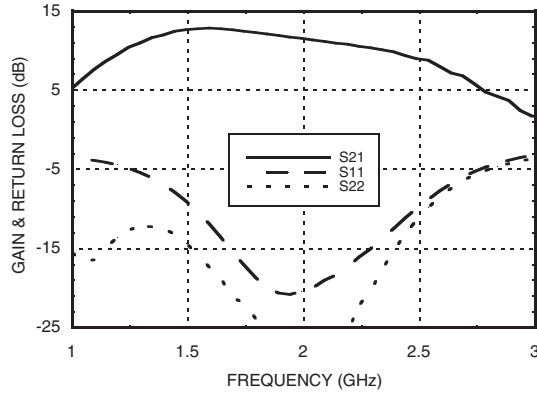

**Gain vs. Temperature**

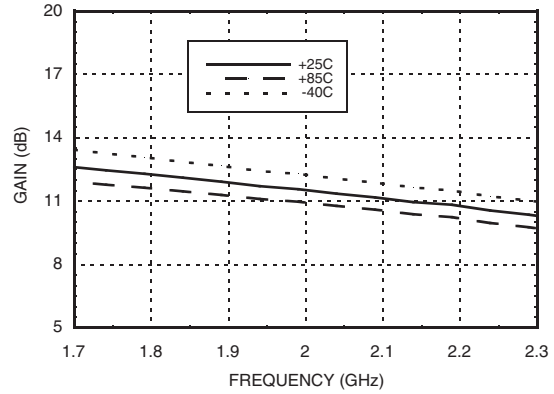

**Input Return Loss vs. Temperature**

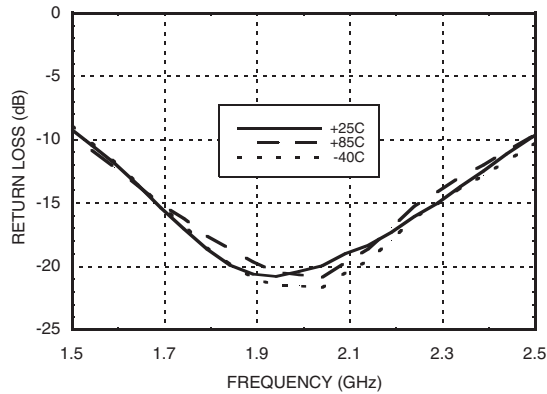

**Output Return Loss vs. Temperature**

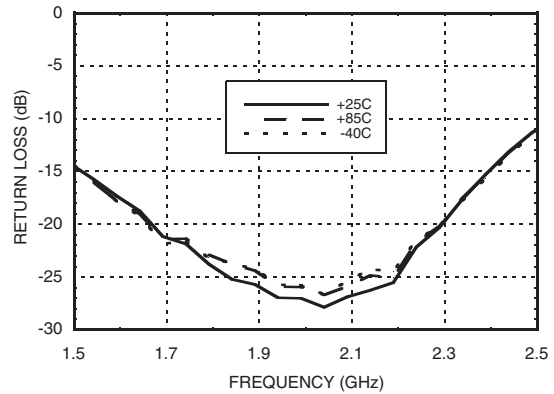

**P1dB vs. Temperature**

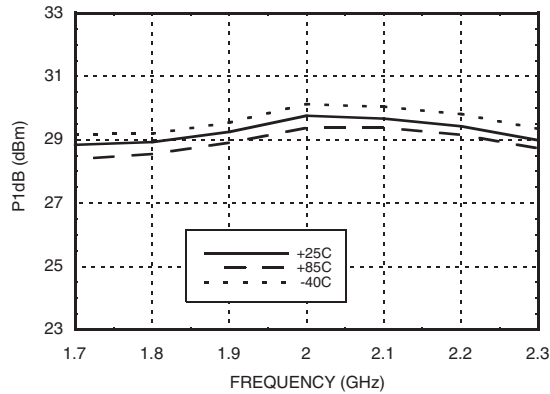

**Psat vs. Temperature**

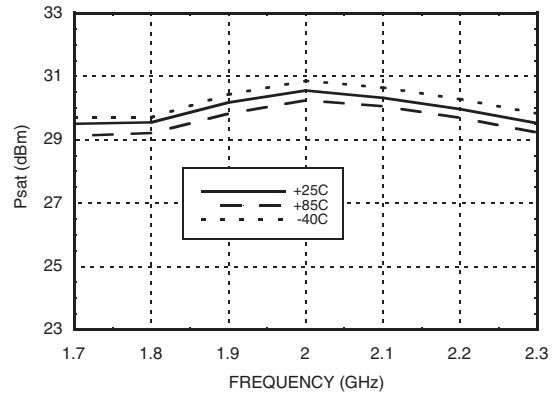

Specifications and data reflect HMC461LP3 measured with external baluns in a balanced amplifier configuration optimized for 1.85 - 2.2 GHz per application circuit herein. Contact HMC Applications for 1.7 - 1.85 GHz performance optimization.

Information furnished by Analog Devices is believed to be accurate and reliable. However, no responsibility is assumed by Analog Devices for its use, nor for any infringements of patents or other rights of third parties that may result from its use. Specifications subject to change without notice. No license is granted by implication or otherwise under any patent or patent rights of Analog Devices. Trademarks and registered trademarks are the property of their respective owners.

For price, delivery, and to place orders: Analog Devices, Inc., One Technology Way, P.O. Box 9106, Norwood, MA 02062-9106 Phone: 781-329-4700 • Order online at [www.analog.com](http://www.analog.com) Application Support: Phone: 1-800-ANALOG-D



**Output IP3 vs. Temperature**

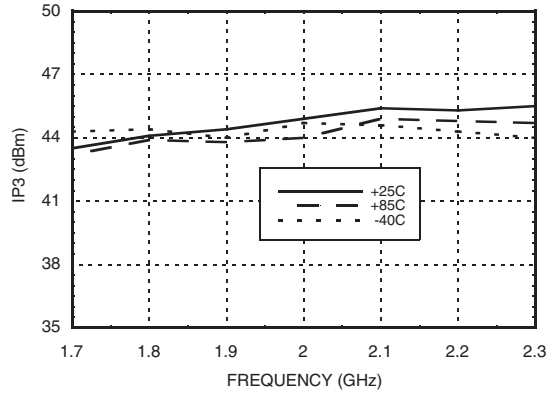

**Noise Figure vs. Temperature**

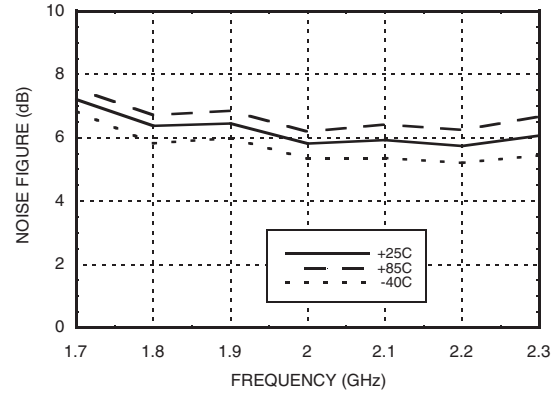

**Power Compression @ 1.95 GHz**

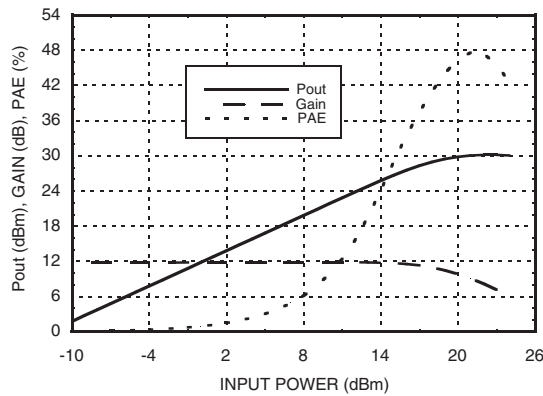

**Power Compression @ 2.15 GHz**

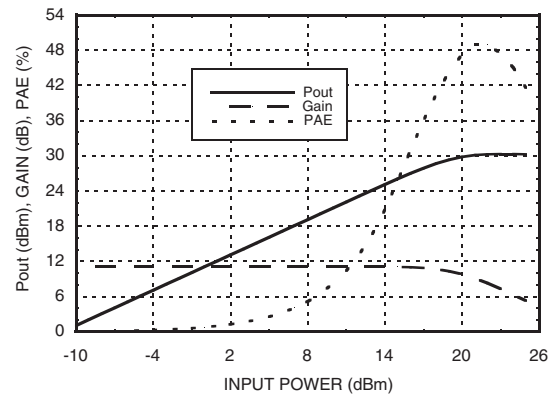

**Reverse Isolation vs. Temperature**

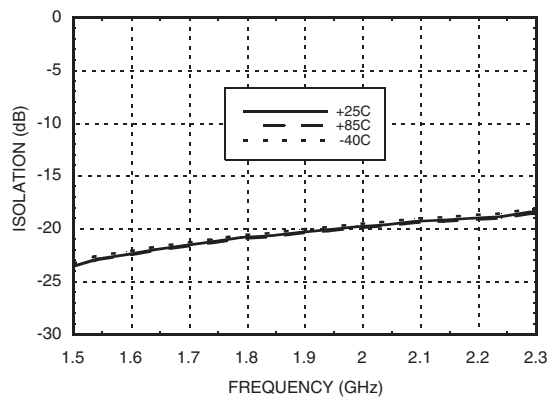

**Gain & Power vs. Supply Voltage @ 2.15 GHz**

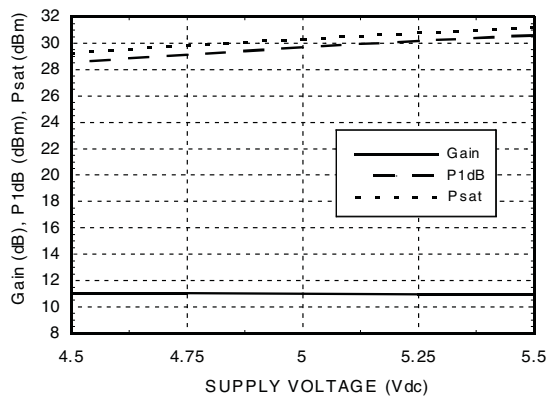

Specifications and data reflect HMC461LP3 measured with external baluns in a balanced amplifier configuration optimized for 1.85 - 2.2 GHz per application circuit herein. Contact HMC Applications for 1.7 - 1.85 GHz performance optimization.

Information furnished by Analog Devices is believed to be accurate and reliable. However, no responsibility is assumed by Analog Devices for its use, nor for any infringements of patents or other rights of third parties that may result from its use. Specifications subject to change without notice. No license is granted by implication or otherwise under any patent or patent rights of Analog Devices. Trademarks and registered trademarks are the property of their respective owners.

For price, delivery, and to place orders: Analog Devices, Inc., One Technology Way, P.O. Box 9106, Norwood, MA 02062-9106 Phone: 781-329-4700 • Order online at [www.analog.com](http://www.analog.com) Application Support: Phone: 1-800-ANALOG-D

## InGaP HBT 1 Watt High IP3 AMPLIFIER, 1.7 - 2.2 GHz



**ACPR vs. Supply Voltage @ 1.96 GHz  
CDMA2000, 9 Channels Forward**

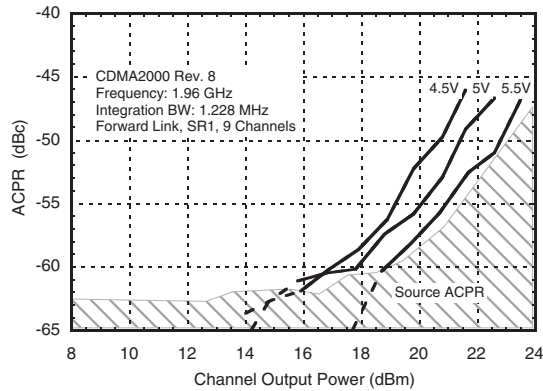

**ACPR vs. Supply Voltage @ 2.14 GHz  
W-CDMA, 64 DCPH**

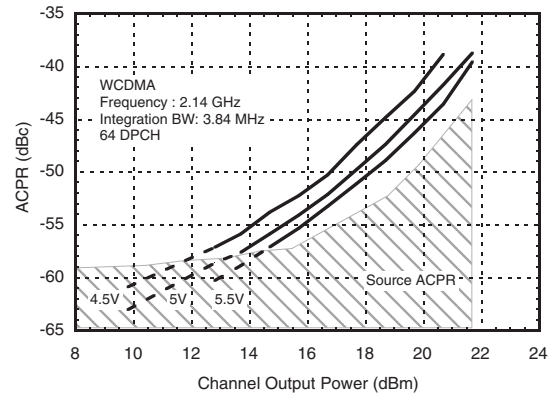

\* Source ACPR: All data is RSS corrected for source ACPR. Dashed lines are shown where corrected data is below source ACPR.

### Output IP2 vs. Temperature

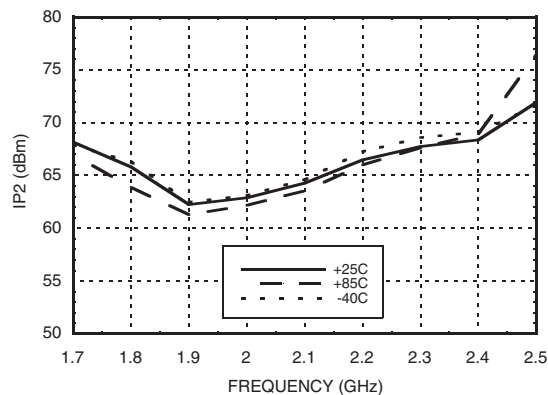

### Absolute Maximum Ratings

Collector Bias Voltage (Vcc1, Vcc2)	+6 Vdc
RF Input Power (RFIN)(Vs = +5Vdc)	+30 dBm
Junction Temperature	150 °C
Continuous P <sub>diss</sub> (T = 85 °C) (derate 32 mW/°C above 85 °C)	2.08 W
Thermal Resistance (junction to ground paddle)	31 °C/W
Storage Temperature	-65 to +150 °C
Operating Temperature	-40 to +85 °C



ELECTROSTATIC SENSITIVE DEVICE  
OBSERVE HANDLING PRECAUTIONS

Specifications and data reflect HMC461LP3 measured with external baluns in a balanced amplifier configuration optimized for 1.85 - 2.2 GHz per application circuit herein.  
Contact HMC Applications for 1.7 - 1.85 GHz performance optimization.

Information furnished by Analog Devices is believed to be accurate and reliable. However, no responsibility is assumed by Analog Devices for its use, nor for any infringements of patents or other rights of third parties that may result from its use. Specifications subject to change without notice. No license is granted by implication or otherwise under any patent or patent rights of Analog Devices. Trademarks and registered trademarks are the property of their respective owners.

For price, delivery, and to place orders: Analog Devices, Inc.,  
One Technology Way, P.O. Box 9106, Norwood, MA 02062-9106  
Phone: 781-329-4700 • Order online at [www.analog.com](http://www.analog.com)  
Application Support: Phone: 1-800-ANALOG-D



### Outline Drawing

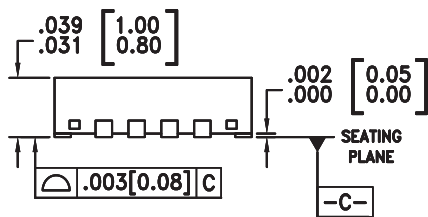
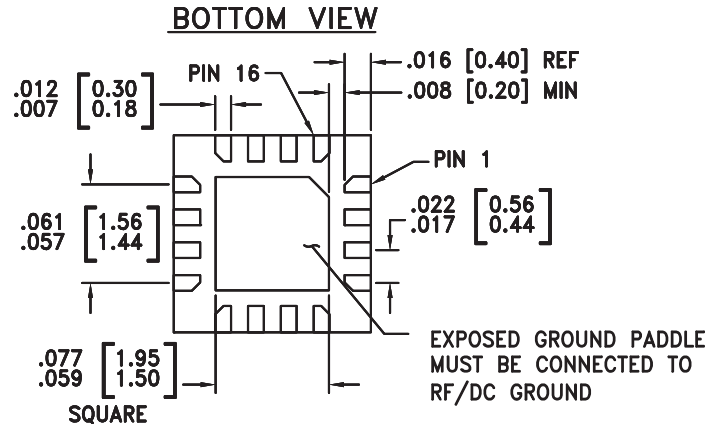
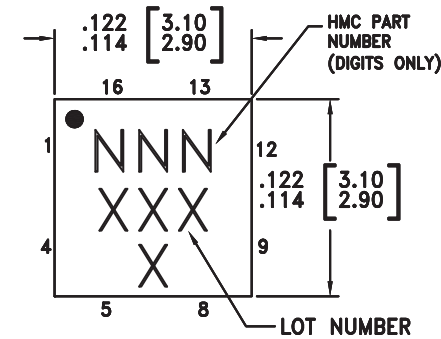

NOTES:

1. LEADFRAME MATERIAL: COPPER ALLOY
2. DIMENSIONS ARE IN INCHES [MILLIMETERS]
3. LEAD SPACING TOLERANCE IS NON-CUMULATIVE
4. PAD BURR LENGTH SHALL BE 0.15mm MAXIMUM.  
PAD BURR HEIGHT SHALL BE 0.05mm MAXIMUM.
5. PACKAGE WARP SHALL NOT EXCEED 0.05mm.
6. ALL GROUND LEADS AND GROUND PADDLE MUST BE SOLDERED TO PCB RF GROUND.
7. REFER TO HITTITE APPLICATION NOTE FOR SUGGESTED LAND PATTERN.

### Package Information

Part Number	Package Body Material	Lead Finish	MSL Rating	Package Marking <sup>[3]</sup>
HMC461LP3	Low Stress Injection Molded Plastic	Sn/Pb Solder	MSL1 <sup>[1]</sup>	461 XXXX
HMC461LP3E	RoHS-compliant Low Stress Injection Molded Plastic	100% matte Sn	MSL1 <sup>[2]</sup>	461 XXXX

[1] Max peak reflow temperature of 235 °C  
 [2] Max peak reflow temperature of 260 °C  
 [3] 4-Digit lot number XXXX

Specifications and data reflect HMC461LP3 measured with external baluns in a balanced amplifier configuration optimized for 1.85 - 2.2 GHz per application circuit herein.  
 Contact HMC Applications for 1.7 - 1.85 GHz performance optimization.



### Pin Descriptions

Pin Number	Function	Description	Interface Schematic
2, 3, 5 - 8, 10, 11, 13 - 16	N/C	This pin may be connected to RF ground.	
1, 4	IN1, IN2	RF Input. This pin is AC coupled. An off chip series matching capacitor is required.	
9, 12	OUT1, OUT2	RF output and DC Bias for the output stage.	
	GND	Package bottom must be connected to RF/DC ground.	

### Recommended Application Circuit for Balanced Amplifier Configuration

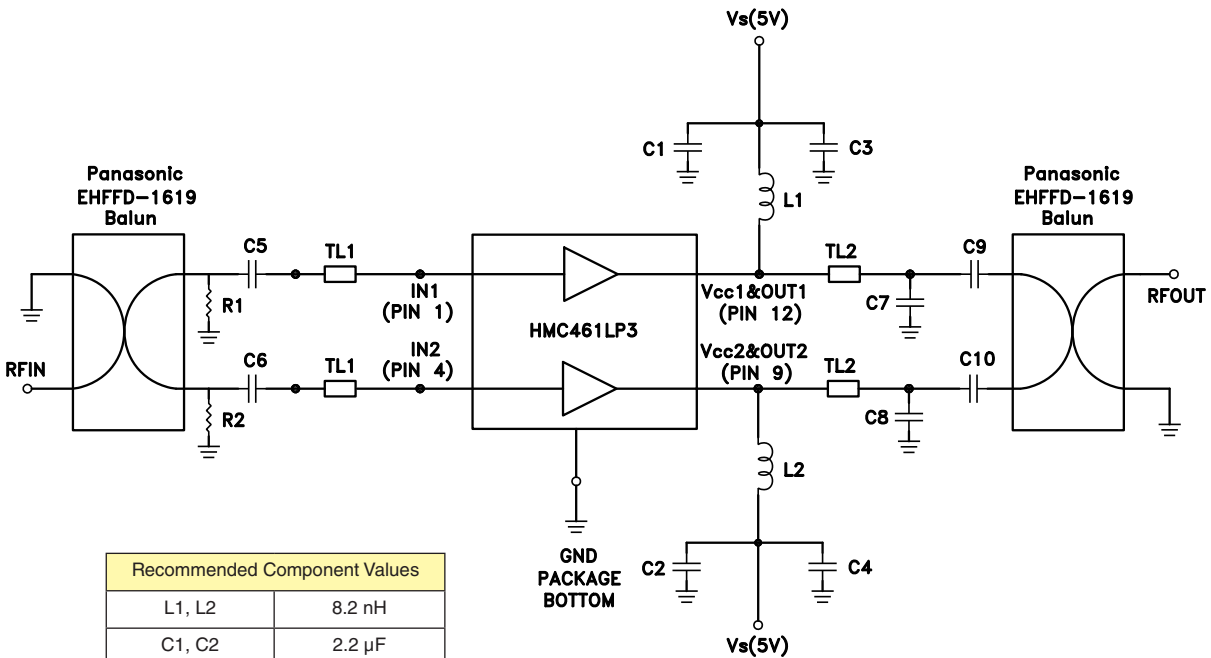

Recommended Component Values	
L1, L2	8.2 nH
C1, C2	2.2 $\mu$ F
C5, C6	5.0 pF
C7, C8	0.9 pF
C3, C4	100 pF
C7, C8	0.8 pF
C9, C10	4.0 pF
R1, R2	130 Ohm

	TL1	TL2
Impedance	50 Ohm	50 Ohm
Physical Length	0.09"	0.18"
Electrical Length	9.5°	19°
PCB Material: 10 mil Rogers 4350, Er = 3.48		

Specifications and data reflect HMC461LP3 measured with external baluns in a balanced amplifier configuration optimized for 1.85 - 2.2 GHz per application circuit herein.  
Contact HMC Applications for 1.7 - 1.85 GHz performance optimization.

Information furnished by Analog Devices is believed to be accurate and reliable. However, no responsibility is assumed by Analog Devices for its use, nor for any infringements of patents or other rights of third parties that may result from its use. Specifications subject to change without notice. No license is granted by implication or otherwise under any patent or patent rights of Analog Devices. Trademarks and registered trademarks are the property of their respective owners.

For price, delivery, and to place orders: Analog Devices, Inc., One Technology Way, P.O. Box 9106, Norwood, MA 02062-9106  
Phone: 781-329-4700 • Order online at [www.analog.com](http://www.analog.com)  
Application Support: Phone: 1-800-ANALOG-D



**Evaluation PCB**

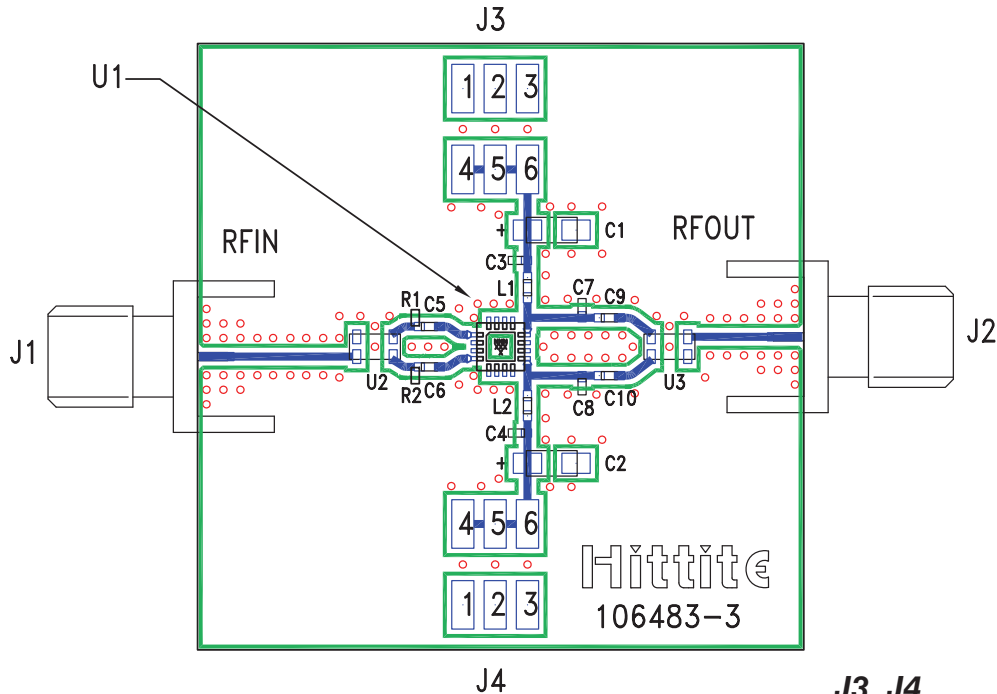

Pin Number	Description
1, 2, 3	GND
4, 5, 6	Vs

**List of Materials for Evaluation PCB 106485 [1]**

Item	Description
J1, J2	PCB Mount SMA Connector
J3, J4	2 mm DC Header
C1, C2	2.2 $\mu$ F Capacitor, Tantalum
C3, C4	100 pF Capacitor, 0402 Pkg.
C5, C6	5 pF Capacitor, 0402 Pkg.
C7, C8	0.8 pF Capacitor, 0402 Pkg.
C9, C10	4 pF Capacitor, 0402 Pkg.
L1, L2	8.2 nH Inductor, 0402 Pkg.
U1	HMC461LP3 / HMC461LP3E Power Amplifier
U2, U3	Panasonic Balun, P/N EHFFD - 1619
PCB [2]	106483 Evaluation PCB, 10 mils

The circuit board used in the final application should use RF circuit design techniques. Signal lines should have 50 ohm impedance while the package ground leads and exposed paddle should be connected directly to the ground plane similar to that shown. A sufficient number of via holes should be used to connect the top and bottom ground planes. The evaluation board should be mounted to an appropriate heat sink. The evaluation circuit board shown is available from Hittite upon request.

[1] Reference this number when ordering complete evaluation PCB

[2] Circuit Board Material: Rogers 4350, Er = 3.48

Specifications and data reflect HMC461LP3 measured with external baluns in a balanced amplifier configuration optimized for 1.85 - 2.2 GHz per application circuit herein. Contact HMC Applications for 1.7 - 1.85 GHz performance optimization.

**Notes:**

v02.0705

**HMC461LP3 / 461LP3E*****InGaP HBT 1 Watt High IP3  
AMPLIFIER, 1.7 - 2.2 GHz*****11****LINEAR & POWER AMPLIFIERS - SMT**