

# Metallized Polypropylene Film Capacitors

## MKP Radial Potted Type

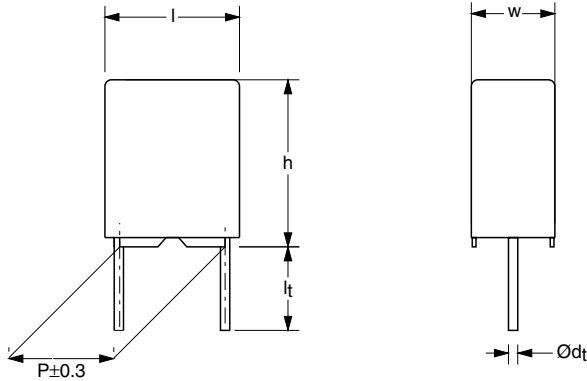

Dimensions in mm

### APPLICATIONS

Low losses due to low contact resistance and low loss dielectric result in applications where high frequency occur or high stability is preferred. Their small dimensions make them suitable for circuits with high packaging density.

### MARKING

C-value; rated voltage; tolerance; code for manufacturer; year and week of manufacture; manufacturers type designation

### DIELECTRIC

Polypropylene film

### ELECTRODES

Vacuum deposited aluminum

### ENCAPSULATION

Flame retardant plastic case and epoxy resin (UL-class 94 V-0)

### CONSTRUCTION

Wound mono construction

### LEADS

Tinned wire

### CAPACITANCE RANGE (E24 SERIES)

0.001 to 1.2  $\mu$ F

### FEATURES

5, 10 and 15 mm lead pitch. Supplied loose in box, in ammpack and taped on reel. Intermediate values are available of the E96 series

Lead (Pb)-free product

RoHS-compliant product

### CAPACITANCE TOLERANCE

$\pm 5\%$ ;  $\pm 2\%$

### RATED (DC) VOLTAGE

63 V; 160 V; 250 V; 400 V; 630 V

### RATED (AC) VOLTAGE

25 V; 63 V; 100 V; 125 V; 160 V

### RATED PEAK-TO-PEAK VOLTAGE

70 V; 180 V; 280 V; 350 V; 450 V

### CLIMATIC CATEGORY

55/085/56

### RATED TEMPERATURE (DC)

85 °C

### RATED TEMPERATURE (AC)

85 °C

### MAXIMUM APPLICATION TEMPERATURE

85 °C

### REFERENCE SPECIFICATIONS

IEC 60384-16

### PERFORMANCE GRADE

Grade 1 (long life)

### STABILITY GRADE

Grade 1

### DETAIL SPECIFICATION

For more detailed data and test requirements contact:  
[filmcaps.roeselare@vishay.com](mailto:filmcaps.roeselare@vishay.com)



**RoHS**  
COMPLIANT

## COMPOSITION OF CATALOG NUMBER

TYPE AND PITCHES	
416	5.0/10.0/15.0 mm
417	5.0/10.0/15.0 mm
418	5.0/10.0/15.0 mm
419	5.0/10.0/15.0 mm
420	5.0/10.0/15.0 mm

**CAPACITANCE**  
(numerically)

MULTIPLIER (nF)	
0.01	2
0.1	3
1	4

2222	4..	XX	XX	X
BFC2*	4..	XX	XX	X

Example:  
1004 = 100 x 1 = 100 nF

\* Use this partnumber for those with access to the Vishay's SAP system and Partners website within the Americas

TYPE	PACKAGING	PITCH (mm)	LEAD CONFIGURATION	PREFERRED TYPES						
				C-TOL	63 V	160 V	250 V	400 V	630 V	
416	Taped; see note	5/10/15	H = 18.5 mm; P <sub>0</sub> = 12.7 mm	± 2 %	1					
	Loose in box	15	lead length 3.5 ± 0.3 mm	± 2 %	7					
417	Taped; see note	5/10/15	H = 18.5 mm; P <sub>0</sub> = 12.7 mm	± 2 %		1				
	Loose in box	15	lead length 3.5 ± 0.3 mm	± 2 %		7				
418	Taped; see note	5/10/15	H = 18.5 mm; P <sub>0</sub> = 12.7 mm	± 2 %			1			
	Loose in box	15	lead length 3.5 ± 0.3 mm	± 2 %			7			
419	Taped; see note	5/10/15	H = 18.5 mm; P <sub>0</sub> = 12.7 mm	± 2 %				1		
	Loose in box	15	lead length 3.5 ± 0.3 mm	± 2 %				7		
420	Taped; see note	5/10/15	H = 18.5 mm; P <sub>0</sub> = 12.7 mm	± 2 %					1	
	Loose in box	15	lead length 3.5 ± 0.3 mm	± 2 %					7	
					ON REQUEST					
416	Taped; see note	5/10/15	H = 18.5 mm; P <sub>0</sub> = 12.7 mm	± 5 %	0					
	Loose in box	5/10	lead length 4.0 + 1.0/- 0.5 mm	± 5 %	3					
		15	lead length 3.5 ± 0.3 mm	± 2 %	4					
417	Taped; see note	5/10/15	H = 18.5 mm; P <sub>0</sub> = 12.7 mm	± 5 %		0				
	Loose in box	5/10	lead length 4.0 + 1.0/- 0.5 mm	± 5 %		3				
		15	lead length 3.5 ± 0.3 mm	± 2 %	4					
418	Taped; see note	5/10/15	H = 18.5 mm; P <sub>0</sub> = 12.7 mm	± 5 %			0			
	Loose in box	5/10	lead length 4.0 + 1.0/- 0.5 mm	± 5 %			3			
		15	lead length 3.5 ± 0.3 mm	± 2 %	4					
419	Taped; see note	5/10/15	H = 18.5 mm; P <sub>0</sub> = 12.7 mm	± 5 %				0		
	Loose in box	5/10	lead length 4.0 + 1.0/- 0.5 mm	± 5 %				3		
		15	lead length 3.5 ± 0.3 mm	± 2 %	4					
420	Taped; see note	5/10/15	H = 18.5 mm; P <sub>0</sub> = 12.7 mm	± 5 %					0	
	Loose in box	5/10	lead length 4.0 + 1.0/- 0.5 mm	± 5 %					3	
		15	lead length 3.5 ± 0.3 mm	± 2 %	4					
		15	lead length 3.5 ± 0.3 mm	± 5 %					6	

**Note:**

Pitch = 5 and 10 mm: taped on ammpack

Pitch = 15 mm: taped on reel with diameter = 356 mm



Metallized Polypropylene Film Capacitors Vishay BCcomponents  
MKP Radial Potted Type

**SPECIFIC REFERENCE DATA**

DESCRIPTION	VALUE				
	at 10 kHz		at 100 kHz		
Tangent of loss angle:					
$C \leq 0.0091 \mu\text{F}$	$\leq 5 \times 10^{-4}$		$\leq 10 \times 10^{-4}$		
$0.0091 \mu\text{F} < C \leq 0.027 \mu\text{F}$	$\leq 5 \times 10^{-4}$		$\leq 15 \times 10^{-4}$		
$0.027 \mu\text{F} < C \leq 0.075 \mu\text{F}$	$\leq 5 \times 10^{-4}$		$\leq 20 \times 10^{-4}$		
$0.075 \mu\text{F} < C \leq 0.11 \mu\text{F}$	$\leq 5 \times 10^{-4}$		$\leq 25 \times 10^{-4}$		
$0.11 \mu\text{F} < C \leq 0.18 \mu\text{F}$	$\leq 10 \times 10^{-4}$		$\leq 30 \times 10^{-4}$		
$0.18 \mu\text{F} < C \leq 0.27 \mu\text{F}$	$\leq 10 \times 10^{-4}$		$\leq 35 \times 10^{-4}$		
$0.27 \mu\text{F} < C \leq 0.39 \mu\text{F}$	$\leq 10 \times 10^{-4}$		$\leq 40 \times 10^{-4}$		
$0.39 \mu\text{F} < C \leq 0.56 \mu\text{F}$	$\leq 10 \times 10^{-4}$		$\leq 45 \times 10^{-4}$		
$0.56 \mu\text{F} < C \leq 0.75 \mu\text{F}$	$\leq 10 \times 10^{-4}$		$\leq 50 \times 10^{-4}$		
$0.75 \mu\text{F} < C \leq 1.1 \mu\text{F}$	$\leq 10 \times 10^{-4}$		$\leq 60 \times 10^{-4}$		
Rated voltage pulse slope $(dU/dt)_R$ :	at 63 V (DC)	at 100 V (DC)	at 250 V (DC)	at 400 V (DC)	at 630 V (DC)
P = 5 mm	50 V/ $\mu\text{s}$	50 V/ $\mu\text{s}$	50 V/ $\mu\text{s}$	50 V/ $\mu\text{s}$	50 V/ $\mu\text{s}$
P = 10 mm	20 V/ $\mu\text{s}$	20 V/ $\mu\text{s}$	20 V/ $\mu\text{s}$	20 V/ $\mu\text{s}$	50 V/ $\mu\text{s}$
P = 15 mm	50 V/ $\mu\text{s}$	50 V/ $\mu\text{s}$	50 V/ $\mu\text{s}$	50 V/ $\mu\text{s}$	50 V/ $\mu\text{s}$
R between leads, for $C \leq 0.33 \mu\text{F}$ :					
at 50 V; 1 minute	> 100000 M $\Omega$				
at 100 V; 1 minute		> 100000 M $\Omega$	> 100000 M $\Omega$	> 100000 M $\Omega$	> 100000 M $\Omega$
RC between leads, for $C > 0.33 \mu\text{F}$ at 10 V; 1 minute	> 30000 s	>30000 s	>30000 s	>30000 s	
R between interconnecting leads and casing; 50 V; 1 minute	> 100000 M $\Omega$	> 100000 M $\Omega$	> 100000 M $\Omega$	> 100000 M $\Omega$	> 100000 M $\Omega$
Withstanding (DC) voltage (cut off current 10 mA); rise time 100 V/s	100 V; 1 minute	260 V; 1 minute	400 V; 1 minute	640 V; 1 minute	1000 V; 1 minute
Withstanding (DC) voltage between leads and case	2840 V; 1 minute	2840 V; 1 minute	2840 V; 1 minute	2840 V; 1 minute	1260 V; 1 minute

# MKP 416 to 420



## Vishay BCcomponents Metallized Polypropylene Film Capacitors MKP Radial Potted Type

$U_{Rdc} = 63 V$ ;  $U_{Rac} = 25 V$ ;  $U_{p-p} = 70 V$

C (E 24) ( $\mu F$ )	DIMENSIONS $w \times h \times l$ (mm)	MASS (g)	CATALOG NUMBER 2222 416 ..... AND PACKAGING							
			AMMOPACK		LOOSE IN BOX		REEL		LOOSE IN BOX	
			H = 18.5 mm; P <sub>0</sub> = 12.7 mm		It = 4.0 + 1.0/- 0.5 mm		H = 18.5 mm; P <sub>0</sub> = 12.7 mm		It = 3.5 ± 0.3 mm	
			C-tol = ± 2 %	SPQ	C-tol = ± 2 %	SPQ	C-tol = ± 2 %	SPQ	C-tol = ± 2 %	SPQ
last 5 digits of catalog number	last 5 digits of catalog number	last 5 digits of catalog number	last 5 digits of catalog number							
<b>Pitch = 5.0 ± 0.3 mm; d<sub>t</sub> = 0.50 ± 0.05 mm</b>										
0.036	4.5 × 9.0 × 7.2	0.45	13603	1000	43603	2000				
0.039			13903		43903					
0.043			14303		44303					
0.047			14703		44703					
0.051	6.0 × 11.0 × 7.2	0.60	15103	750	45103	1500				
0.056			15603		45603					
0.062			16203		46203					
0.068			16803		46803					
0.075			17503		47503					
0.082			18203		48203					
0.091			19103		49103					
0.1			11004		41004					
0.11	11104	41104								
0.12	11204	41204								
<b>Pitch = 10.0 ± 0.4 mm; d<sub>t</sub> = 0.60 ± 0.06 mm</b>										
0.13	5.0 × 11.0 × 12.5	0.85	11304	600	41304	1000				
0.15			11504		41504					
0.16	6.0 × 12.0 × 12.5	1.10	11604	500	41604	750				
0.18			11804		41804					
0.20			12004		42004					
0.22			12204		42204					
0.24			12404		42404					
0.27			12704		42704					
<b>Pitch = 15.0 ± 0.4 mm; d<sub>t</sub> = 0.60 ± 0.06 mm</b>										
0.3	6.0 × 12.0 × 17.5	1.4			13004	900	73004	1000		
0.33			13304	73304						
0.36			13604	73604						
0.39			13904	73904						
<b>Pitch = 15.0 ± 0.4 mm; d<sub>t</sub> = 0.80 ± 0.08 mm</b>										
0.43	7.0 × 13.5 × 17.5	1.9			14304	800	74304	750		
0.47			14704	74704						
0.51			15104	75104						
0.56			15604	75604						
0.62	8.5 × 15.0 × 17.5	2.6			16204	650	76204	750		
0.68			16804	76804						
0.75			17504	77504						
0.82			18204	78204						
0.91	10.0 × 16.5 × 17.5	3.1			19104	600	79104	500		
1.0			11005	71005						
1.1			11105	71105						



Metallized Polypropylene Film Capacitors Vishay BCcomponents  
MKP Radial Potted Type

$U_{Rdc} = 160\text{ V}$ ;  $U_{Rac} = 63\text{ V}$ ;  $U_{p-p} = 180\text{ V}$

C (E 24) ( $\mu\text{F}$ )	DIMENSIONS $w \times h \times l$ (mm)	MASS (g)	CATALOG NUMBER 2222 417 ..... AND PACKAGING							
			AMMOPACK		LOOSE IN BOX		REEL		LOOSE IN BOX	
			H = 18.5 mm; P <sub>0</sub> = 12.7 mm		It = 4.0 + 1.0/- 0.5 mm		H = 18.5 mm; P <sub>0</sub> = 12.7 mm		It = 3.5 ± 0.3 mm	
			C-tol = ± 2 %	SPQ	C-tol = ± 2 %	SPQ	C-tol = ± 2 %	SPQ	C-tol = ± 2 %	SPQ
last 5 digits of catalog number	last 5 digits of catalog number	last 5 digits of catalog number	last 5 digits of catalog number							
<b>Pitch = 5.0 ± 0.3 mm; d<sub>t</sub> = 0.50 ± 0.05 mm</b>										
0.024	4.5 × 9.0 × 7.2	0.45	12403	1000	42403	2000				
0.027			12703		42703					
0.03			13003		43003					
0.033			13303		43303					
0.036	6.0 × 11.0 × 7.2	0.60	13603	750	43603	1500				
0.039			13903		43903					
0.043			14303		44303					
0.047			14703		44703					
0.051			15103		45103					
0.056			15603		45603					
0.062			16203		46203					
0.068			16803		46803					
<b>Pitch = 10.0 ± 0.4 mm; d<sub>t</sub> = 0.60 ± 0.06 mm</b>										
0.075	4.0 × 10.0 × 12.5	0.60	17503	750	47503	1000				
0.082			18203		48203					
0.091			19103		49103					
0.1			11004		41004					
0.11	5.0 × 11.0 × 12.5	0.85	11104	600	41104	1000				
0.12			11204		41204					
0.13			11304		41304					
0.15			11504		41504					
0.16	6.0 × 12.0 × 12.5	1.10	11604	500	41604	750				
0.18			11804		41804					
0.20			12004		42004					
0.22			12204		42204					
0.24			12404		42404					
<b>Pitch = 15.0 ± 0.4 mm; d<sub>t</sub> = 0.60 ± 0.06 mm</b>										
0.27	5.0 × 11.0 × 17.5	1.2			12704	1100	72704	1250		
0.3	6.0 × 12.0 × 17.5	1.4			13004	900	73004	1000		
0.33			13304	73304						
0.36			13604	73604						
0.39			13904	73904						
<b>Pitch = 15.0 ± 0.4 mm; d<sub>t</sub> = 0.80 ± 0.08 mm</b>										
0.43	7.0 × 13.5 × 17.5	1.9			14304	800	74304	750		
0.47			14704	74704						
0.51			15104	75104						
0.56			15604	75604						
0.62	8.5 × 15.0 × 17.5	2.6			16204	650	76204	750		
0.68			16804	76804						
0.75			17504	77504						
0.82			18204	78204						
0.91	10.0 × 16.5 × 17.5	3.1			19104	600	79104	500		
1.0			11005	71005						
1.1			11105	71105						

# MKP 416 to 420



## Vishay BCcomponents Metallized Polypropylene Film Capacitors MKP Radial Potted Type

$U_{Rdc} = 250 \text{ V}$ ;  $U_{Rac} = 25 \text{ V}$ ;  $U_{p-p} = 70 \text{ V}$

C (E 24) ( $\mu\text{F}$ )	DIMENSIONS $w \times h \times l$ (mm)	MASS (g)	CATALOG NUMBER 2222 418 ..... AND PACKAGING							
			AMMOPACK		LOOSE IN BOX		REEL		LOOSE IN BOX	
			H = 18.5 mm; P <sub>0</sub> = 12.7 mm		It = 4.0 + 1.0/- 0.5 mm		H = 18.5 mm; P <sub>0</sub> = 12.7 mm		It = 3.5 ± 0.3 mm	
			C-tol = ± 2 % last 5 digits of catalog number	SPQ	C-tol = ± 2 % last 5 digits of catalog number	SPQ	C-tol = ± 2 % last 5 digits of catalog number	SPQ	C-tol = ± 2 % last 5 digits of catalog number	SPQ
<b>Pitch = 5.0 ± 0.3 mm; d<sub>t</sub> = 0.50 ± 0.05 mm</b>										
0.01	3.5 × 8.0 × 7.2	0.35	11003	1500	41003	3000				
0.011			11103		41103					
0.012			11203		41203					
0.013			11303		41303					
0.015			11503		41503					
0.016	4.5 × 9.0 × 7.2	0.45	11603	1000	41603	2000				
0.018			11803		41803					
0.02			12003		42003					
0.022			12203		42203					
0.024			12403		42403					
0.027	6.0 × 11.0 × 7.2	0.60	12703	750	42703	1500				
0.03			13003		43003					
0.033			13303		43303					
0.036			13603		43603					
0.039			13903		43903					
0.043			14303		44303					
<b>Pitch = 10.0 ± 0.4 mm; d<sub>t</sub> = 0.60 ± 0.06 mm</b>										
0.047	4.0 × 10.0 × 12.5	0.60	14703	750	44703	1000				
0.051			15103		45103					
0.056			15603		45603					
0.062			16203		46203					
0.068			16803		46803					
0.075	5.0 × 11.0 × 12.5	0.85	17503	600	47503	1000				
0.082			18203		48203					
0.091			19103		49103					
0.1	6.0 × 12.0 × 12.5	1.10	11004	500	41004	750				
0.11			11104		41104					
0.12			11204		41204					
0.13			11304		41304					
<b>Pitch = 15.0 ± 0.4 mm; d<sub>t</sub> = 0.60 ± 0.06 mm</b>										
0.15	5.0 × 11.0 × 17.5	1.2			11504	1100	71504		1250	
0.16			11604		71604					
0.18	6.0 × 12.0 × 17.5	1.4			11804	900	71804		1000	
0.2			12004		72004					
0.22			12204		72204					
0.24			12404		72404					
<b>Pitch = 15.0 ± 0.4 mm; d<sub>t</sub> = 0.80 ± 0.08 mm</b>										
0.27	7.0 × 13.5 × 17.5	1.9			12704	800	72704		750	
0.3			13004		73004					
0.33			13304		73304					
0.36			13604		73604					
0.39	8.5 × 15.0 × 17.5	2.6			13904	650	73904		750	
0.43			14304		74304					
0.47			14704		74704					
0.51			15104		75104					
0.56	10.0 × 16.5 × 17.5	3.1			15604	600	75604		500	
0.62			16204		76204					
0.68			16804		76804					



Metallized Polypropylene Film Capacitors Vishay BCcomponents  
MKP Radial Potted Type

$U_{Rdc} = 400\text{ V}$ ;  $U_{Rac} = 125\text{ V}$ ;  $U_{p-p} = 350\text{ V}$

C (E 24) ( $\mu\text{F}$ )	DIMENSIONS $w \times h \times l$ (mm)	MASS (g)	CATALOG NUMBER 2222 419 ..... AND PACKAGING							
			AMMOPACK		LOOSE IN BOX		REEL		LOOSE IN BOX	
			H = 18.5 mm; P <sub>0</sub> = 12.7 mm		It = 4.0 + 1.0/- 0.5 mm		H = 18.5 mm; P <sub>0</sub> = 12.7 mm		It = 3.5 ± 0.3 mm	
			C-tol = ± 2 %		C-tol = ± 2 %		C-tol = ± 2 %		C-tol = ± 2 %	
			last 5 digits of catalog number	SPQ	last 5 digits of catalog number	SPQ	last 5 digits of catalog number	SPQ	last 5 digits of catalog number	SPQ
<b>Pitch = 5.0 ± 0.3 mm; d<sub>t</sub> = 0.50 ± 0.05 mm</b>										
0.001	3.5 × 8.0 × 7.2	0.35	11002	1500	41002	3000				
0.0011			11102		41102					
0.0012			11202		41202					
0.0013			11302		41302					
0.0015			11502		41502					
0.0016			11602		41602					
0.0018			11802		41802					
0.002			12002		42002					
0.0022			12202		42202					
0.0024			12402		42402					
0.0027			12702		42702					
0.003			13002		43002					
0.0033			13302		43302					
0.0036			13602		43602					
0.0039			13902		43902					
0.0043			4.5 × 9.0 × 7.2		0.45		14302	1000	44302	2000
0.0047	14702	44702								
0.0051	15102	45102								
0.0056	15602	45602								
0.0062	16202	46202								
0.0068	16802	46802								
0.0075	17502	47502								
0.0082	18202	48202								
0.0091	19102	49102								
0.01	11003	41003								
0.011	11103	41103								
0.012	11203	41203								
0.013	6.0 × 11.0 × 7.2	0.60	11303	750	41303	1500				
0.015			11503		41503					
0.016			11603		41603					
0.018			11803		41803					
0.02			12003		42003					
<b>Pitch = 10.0 ± 0.4 mm; d<sub>t</sub> = 0.60 ± 0.06 mm</b>										
0.022	4.0 × 10.0 × 12.5	0.60	12203	750	42203	1000				
0.024			12403		42403					
0.027			12703		42703					
0.03			13003		43003					
0.033			13303		43303					
0.036	5.0 × 11.0 × 12.5	0.85	13603	600	43603	1000				
0.039			13903		43903					
0.043			14303		44303					

# MKP 416 to 420



## Vishay BCcomponents Metallized Polypropylene Film Capacitors MKP Radial Potted Type

C (E 24) ( $\mu$ F)	DIMENSIONS w × h × l (mm)	MASS (g)	CATALOG NUMBER 2222 419 ..... AND PACKAGING							
			AMMOPACK		LOOSE IN BOX		REEL		LOOSE IN BOX	
			H = 18.5 mm; P <sub>0</sub> = 12.7 mm		It = 4.0 + 1.0/- 0.5 mm		H = 18.5 mm; P <sub>0</sub> = 12.7 mm		It = 3.5 ± 0.3 mm	
			C-tol = ± 2 %	SPQ	C-tol = ± 2 %	SPQ	C-tol = ± 2 %	SPQ	C-tol = ± 2 %	SPQ
last 5 digits of catalog number	last 5 digits of catalog number	last 5 digits of catalog number	last 5 digits of catalog number							
0.047	6.0 × 12.0 × 12.5	1.10	14703	500	44703	750				
0.051			15103		45103					
0.056			15603		45603					
0.062			16203		46203					
0.068			16803		46803					
<b>Pitch = 15.0 ± 0.4 mm; d<sub>t</sub> = 0.60 ± 0.06 mm</b>										
0.075	5.0 × 11.0 × 17.5	1.2			17503	1100	77503	1250		
0.082					18203		78203			
0.091	6.0 × 12.0 × 17.5	1.4			19103	900	79103	1000		
0.1					11004		71004			
0.11					11104		71104			
0.12					11204		71204			
0.13					11304		71304			
<b>Pitch = 15.0 ± 0.4 mm; d<sub>t</sub> = 0.80 ± 0.08 mm</b>										
0.15	7.0 × 13.5 × 17.5	1.9			11504	800	71504	750		
0.16					11604		71604			
0.18					11804		71804			
0.2	8.5 × 15.0 × 17.5	2.6			12004	650	72004	750		
0.22					12204		72204			
0.24					12404		72404			
0.27					12704		72704			
0.3	10.0 × 16.5 × 17.5	3.1			13004	600	73004	500		
0.33					13304		73304			
0.36					13604		73604			





Metallized Polypropylene Film Capacitors Vishay BCcomponents  
MKP Radial Potted Type

$U_{Rdc} = 630\text{ V}$ ;  $U_{Rac} = 160\text{ V}$ ;  $U_{p-p} = 450\text{ V}$

C (E 24) ( $\mu\text{F}$ )	DIMENSIONS $w \times h \times l$ (mm)	MASS (g)	CATALOG NUMBER 2222 420 ..... AND PACKAGING							
			AMMOPACK		LOOSE IN BOX		REEL		LOOSE IN BOX	
			H = 18.5 mm; P <sub>0</sub> = 12.7 mm		It = 4.0 + 1.0/- 0.5 mm		H = 18.5 mm; P <sub>0</sub> = 12.7 mm		It = 3.5 ± 0.3 mm	
			C-tol = ± 2 %		C-tol = ± 2 %		C-tol = ± 2 %		C-tol = ± 2 %	
			last 5 digits of catalog number	SPQ	last 5 digits of catalog number	SPQ	last 5 digits of catalog number	SPQ	last 5 digits of catalog number	SPQ
<b>Pitch = 5.0 ± 0.3 mm; d<sub>t</sub> = 0.50 ± 0.05 mm</b>										
0.0015	3.5 × 8.0 × 7.2	0.35	11502	1500	41502	3000				
0.0016			11602		41602					
0.0018			11802		41802					
0.002			12002		42002					
0.0022			12202		42202					
0.0024			12402		42402					
0.0027			12702		42702					
0.003	4.5 × 9.0 × 7.2	0.45	13002	1000	43002	2000				
0.0033			13302		43302					
0.0036			13602		43602					
0.0039			13902		43902					
0.0043	6.0 × 11.0 × 7.2	0.60	14302	750	44302	1500				
0.0047			14702		44702					
0.0051			15102		45102					
0.0056			15602		45602					
0.0062			16202		46202					
0.0068			16802		46802					
<b>Pitch = 10.0 ± 0.4 mm; d<sub>t</sub> = 0.60 ± 0.06 mm</b>										
0.01	4.0 × 10.0 × 12.5	0.60	11003	750	41003	1000				
0.011			11103		41103					
0.012			11203		41203					
0.013			11303		41303					
0.015			11503		41503					
0.016			11603		41603					
0.018	5.0 × 11.0 × 12.5	0.85	11803	600	41803	1000				
0.02			12003		42003					
0.022			12203		42203					
0.024			12403		42403					
0.027	6.0 × 12.0 × 12.5	1.10	12703	500	42703	750				
0.03			13003		43003					
0.033			13303		43303					
0.036			13603		43603					
0.039			13903		43903					
0.043			14303		44303					
0.047			14703		44703					
<b>Pitch = 15.0 ± 0.4 mm; d<sub>t</sub> = 0.60 ± 0.06 mm</b>										
0.051	6.0 × 12.0 × 17.5	1.4			15103	900	75103	1000		
0.056					15603		75603			
<b>Pitch = 15.0 ± 0.4 mm; d<sub>t</sub> = 0.80 ± 0.08 mm</b>										
0.062	7.0 × 13.5 × 17.5	1.9			16203	800	76203	750		
0.068					16803		76803			
0.075					17503		77503			
0.082					18203		78203			
0.091	8.5 × 15.0 × 17.5	2.6			19103	650	79103	750		
0.1					11004		71004			
0.11					11104		71104			
0.12					11204		71204			
0.13	10.0 × 16.5 × 17.5	3.1			11304	600	71304	500		
0.15					11504		71504			
0.16					11604		71604			

## MAXIMUM RMS VOLTAGE (SENAWA) AS A FUNCTION OF FREQUENCY

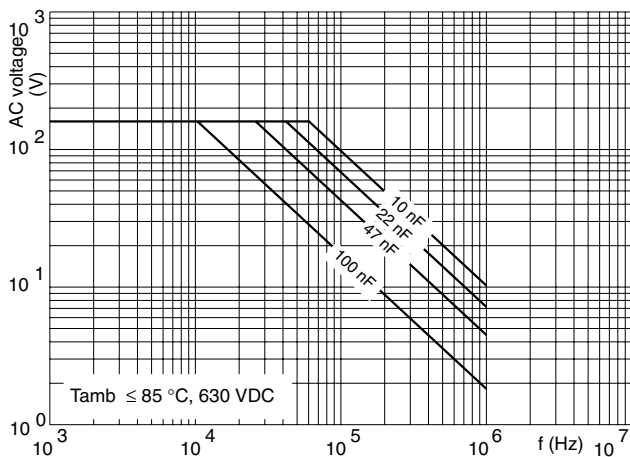
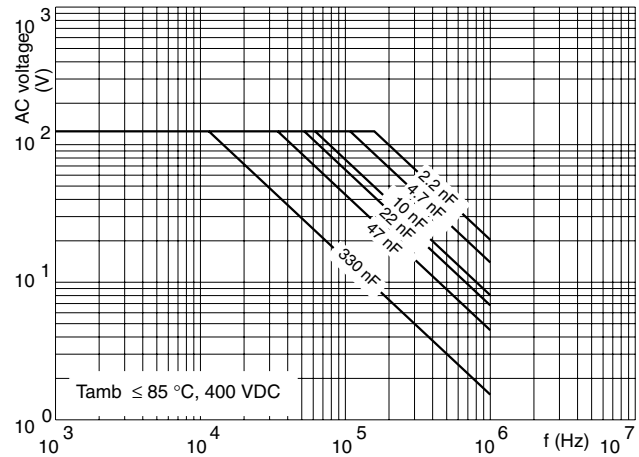
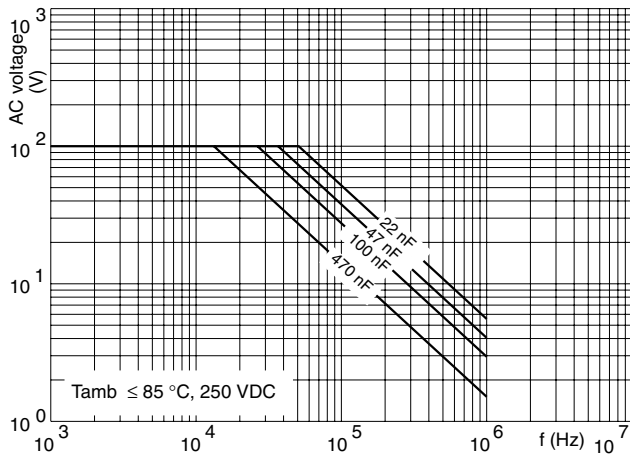
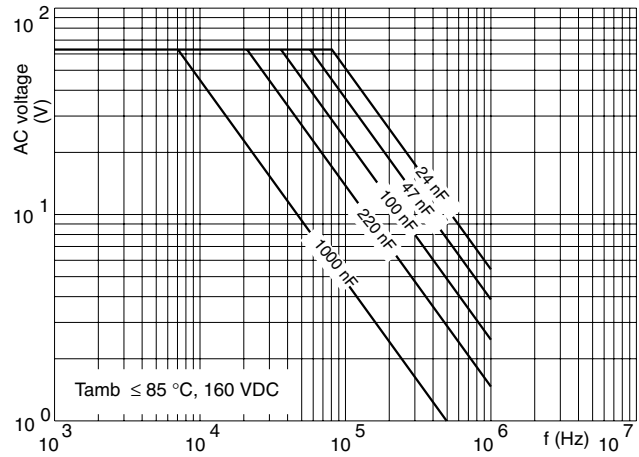
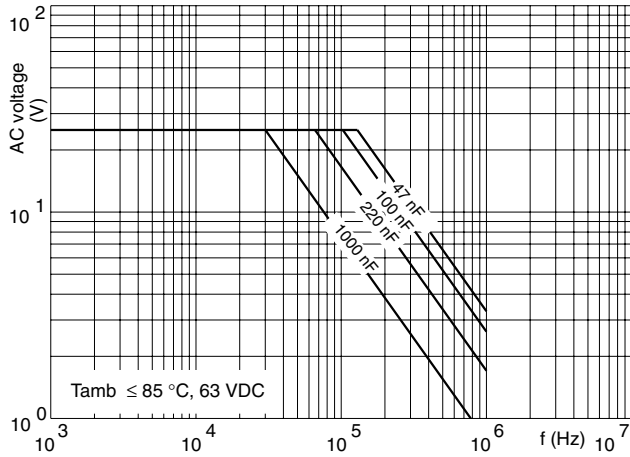



CAPACITANCE

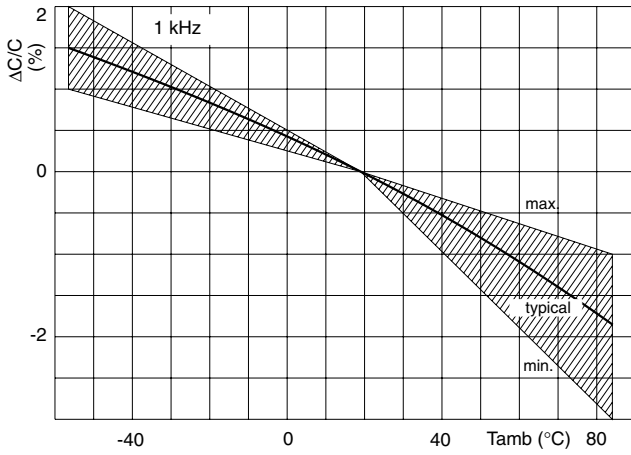

IMPEDANCE

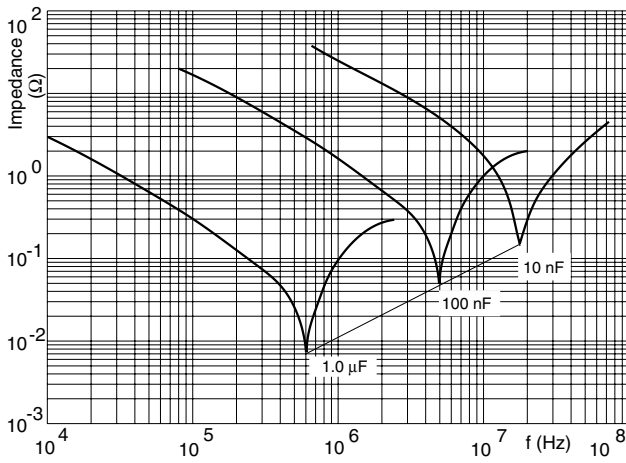



## **Disclaimer**

ALL PRODUCT, PRODUCT SPECIFICATIONS AND DATA ARE SUBJECT TO CHANGE WITHOUT NOTICE TO IMPROVE RELIABILITY, FUNCTION OR DESIGN OR OTHERWISE.

Vishay Intertechnology, Inc., its affiliates, agents, and employees, and all persons acting on its or their behalf (collectively, "Vishay"), disclaim any and all liability for any errors, inaccuracies or incompleteness contained in any datasheet or in any other disclosure relating to any product.

Vishay makes no warranty, representation or guarantee regarding the suitability of the products for any particular purpose or the continuing production of any product. To the maximum extent permitted by applicable law, Vishay disclaims (i) any and all liability arising out of the application or use of any product, (ii) any and all liability, including without limitation special, consequential or incidental damages, and (iii) any and all implied warranties, including warranties of fitness for particular purpose, non-infringement and merchantability.

Statements regarding the suitability of products for certain types of applications are based on Vishay's knowledge of typical requirements that are often placed on Vishay products in generic applications. Such statements are not binding statements about the suitability of products for a particular application. It is the customer's responsibility to validate that a particular product with the properties described in the product specification is suitable for use in a particular application. Parameters provided in datasheets and / or specifications may vary in different applications and performance may vary over time. All operating parameters, including typical parameters, must be validated for each customer application by the customer's technical experts. Product specifications do not expand or otherwise modify Vishay's terms and conditions of purchase, including but not limited to the warranty expressed therein.

Hyperlinks included in this datasheet may direct users to third-party websites. These links are provided as a convenience and for informational purposes only. Inclusion of these hyperlinks does not constitute an endorsement or an approval by Vishay of any of the products, services or opinions of the corporation, organization or individual associated with the third-party website. Vishay disclaims any and all liability and bears no responsibility for the accuracy, legality or content of the third-party website or for that of subsequent links.

Vishay products are not designed for use in life-saving or life-sustaining applications or any application in which the failure of the Vishay product could result in personal injury or death unless specifically qualified in writing by Vishay. Customers using or selling Vishay products not expressly indicated for use in such applications do so at their own risk. Please contact authorized Vishay personnel to obtain written terms and conditions regarding products designed for such applications.

No license, express or implied, by estoppel or otherwise, to any intellectual property rights is granted by this document or by any conduct of Vishay. Product names and markings noted herein may be trademarks of their respective owners.