

APPROVAL SHEET

WQCW1005
SMD Wire Wound Ceramic Chip Inductors
AEC-Q200



*Contents in this sheet are subject to change without prior notice.

FEATURES

1. Ceramic structure provides high reliability · high productivity
2. Excellence Q and SRF characteristics for RF application
3. Wide range inductance and various tolerance options.
4. RoHS compliant
5. AEC-Q200

APPLICATIONS

1. Communication: GSM/3G/LTE, Wi-Fi, GPS
2. Consumer: Cabel/Terrestrial/BS Tuner, Bluetooth, Wireless Audio, Remote control
3. M2M: ZigBee, Proprietary wireless
4. EMI solution in high frequency circuits.
5. Automotive

SHAPE and DIMENSION

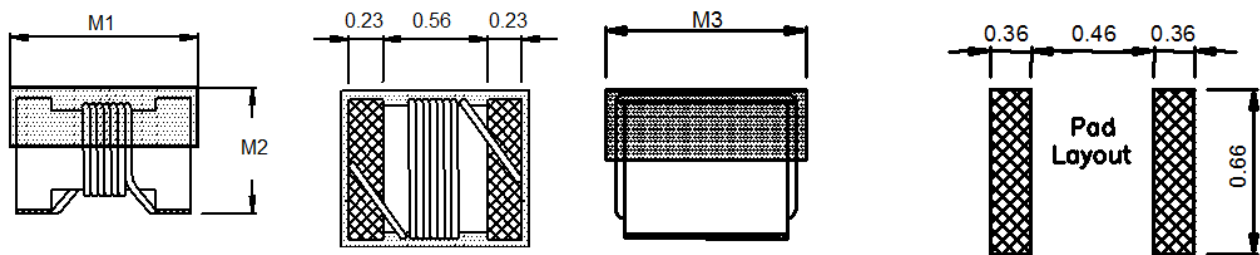

Unit: mm

Series	M1	M2	M3
WQCW1005	1.19(MAX)	0.66(MAX)	0.64(MAX)

Ordering Information

WQ	CW	1005	Z0	J	1N2	T	B
Product Code WQ: Inductor AEC-Q200	Series SMD Wire Wound Ceramic Chip inductor.	Dimensions 1.0 * 0.5 mm 1005 :EIA 0402	Series extension Z0	Tolerance G: ± 2% H: ± 3% J: ± 5%	Value 1N2 =1.2nH 12N=12nH R12=120nH =0.12uH	Packing Code T= 7" Paper Tape	B:STD

Electrical Characteristics

● WQCW1005 series

Walsin Part Number	L (nH)	Tolerance	Q (Min)	L (typ.)	Q (typ.)	L (typ.)	Q (typ.)	SRF (GHz) Min	RDC Max (Ω)	I _{rms} (mA)
				@900MHz		@1700MHz				
WQCW1005Z0□1N0TB	1.0	J、K	16	1.02	75	1.02	70	12.7	0.045	1360
WQCW1005Z0□1N2TB	1.2	J、K	16	1.17	30	1.17	40	12.9	0.09	740
WQCW1005Z0□1N8TB	1.8	J、K	16	2.08	59	1.94	74	12	0.07	1040
WQCW1005Z0□1N9TB	1.9	J、K	16	1.72	65	1.74	80	11.3	0.07	1040
WQCW1005Z0□2N0TB	2.0	G、J、K	16	1.93	54	1.93	75	11.1	0.07	1040
WQCW1005Z0□2N2TB	2.2	G、J、K	19	2.19	55	2.23	82	10.8	0.07	960
WQCW1005Z0□2N4TB	2.4	G、J、K	15	2.24	51	2.27	70	10.5	0.068	790
WQCW1005Z0□2N7TB	2.7	G、J、K	16	2.58	42	2.6	61	10.4	0.12	640
WQCW1005Z0□3N3TB	3.3	G、J、K	19	3.1	65	3.12	80	7	0.066	840
WQCW1005Z0□3N6TB	3.6	G、J、K	19	3.56	45	3.62	71	6.8	0.066	840
WQCW1005Z0□3N9TB	3.9	G、J、K	19	3.89	50	4.14	72	6	0.066	840
WQCW1005Z0□4N3TB	4.3	G、J、K	18	4.19	40	4.3	71	6	0.091	700
WQCW1005Z0□4N7TB	4.7	G、J、K	15	4.78	47	4.59	62	4.7	0.13	640
WQCW1005Z0□5N1TB	5.1	G、J、K	20	5.16	52	5.19	76	4.8	0.083	800
WQCW1005Z0□5N6TB	5.6	G、J、K	20	5.2	48	5.28	75	4.8	0.083	760
WQCW1005Z0□6N2TB	6.2	G、J、K	20	6.15	50	6.2	73	4.8	0.083	760
WQCW1005Z0□6N8TB	6.8	G、J、K	20	6.73	65	6.95	70	4.8	0.083	680
WQCW1005Z0□7N3TB	7.3	G、J、K	20	7.25	58	7.47	71	4.8	0.26	680
WQCW1005Z0□7N5TB	7.5	G、J、K	22	7.91	60	8.22	85	4.8	0.1	680
WQCW1005Z0□8N2TB	8.2	G、J、K	22	8.53	64	8.81	88	4.4	0.1	680
WQCW1005Z0□8N7TB	8.7	G、J、K	18	8.78	54	9.21	73	4.1	0.2	480
WQCW1005Z0□9N1TB	9.1	G、J、K	22	9.27	63	8.61	73	4.16	0.1	680
WQCW1005Z0□9N5TB	9.5	G、J、K	18	9.64	62	9.93	56	4	0.2	480
WQCW1005Z0□10NTB	10	G、J、K	21	10.16	50	9.72	85	3.9	0.2	480
WQCW1005Z0□11NTB	11	G、J、K	24	10.89	53	11.46	77	3.68	0.12	640
WQCW1005Z0□12NTB	12	G、J、K	24	12.71	62	12.87	77	3.6	0.12	640
WQCW1005Z0□13NTB	13	G、J、K	24	13.4	51	14.63	57	3.45	0.21	440
WQCW1005Z0□15NTB	15	G、J、K	24	15.2	55	16.88	76	3.28	0.17	560
WQCW1005Z0□16NTB	16	G、J、K	24	16.43	45	18.79	49	3.1	0.22	560
WQCW1005Z0□18NTB	18	G、J、K	25	17.39	52	22.18	64	3.1	0.23	420
WQCW1005Z0□19NTB	19	G、J、K	24	19.51	60	21.85	72	3.04	0.2	480
WQCW1005Z0□20NTB	20	G、J、K	25	20.7	52	23.66	53	3	0.25	420
WQCW1005Z0□22NTB	22	G、J、K	25	22.33	57	26.54	53	2.8	0.3	400
WQCW1005Z0□23NTB	23	G、J、K	22	23.8	49	26.85	64	2.72	0.3	400
WQCW1005Z0□24NTB	24	G、J、K	25	25.59	59	31.06	56	2.7	0.3	400
WQCW1005Z0□27NTB	27	G、J、K	24	29.26	45	32.56	62	2.48	0.3	400
WQCW1005Z0□30NTB	30	G、J、K	25	31.9	45	40.38	41	2.35	0.3	400
WQCW1005Z0□33NTB	33	G、J、K	24	34.12	35	40.32	36	2.35	0.44	400

Walsin Part Number	L (nH)	Tolerance	Q (Min)	L (typ)	Q (typ.)	L (typ.)	Q (typ.)	SRF (GHz) Min	RDC Max (Ω)	I _{rms} (mA)
				@900MHz		@1700MHz				
WQCW1005Z0□36NTB	36	G、J、K	24	39.5	45	48.4	53	2.32	0.44	320
WQCW1005Z0□39NTB	39	G、J、K	25	42.65	45	50.96	42	2.1	0.55	200
WQCW1005Z0□40NTB	40	G、J、K	24	39.0	44	47.41	35	2.24	0.44	320
WQCW1005Z0□43NTB	43	G、J、K	25	45.8	46	61.55	35	2.03	0.81	100
WQCW1005Z0□47NTB	47	G、J、K	20	52.85	42	-	-	2.1	0.83	150
WQCW1005Z0□51NTB	51	G、J、K	25	56.6	40	-	-	1.75	0.82	100
WQCW1005Z0□56NTB	56	G、J、K	22	58.59	40	-	-	1.76	0.97	100
WQCW1005Z0□68NTB	68	G、J、K	22	72.17	40	-	-	1.62	1.12	100
WQCW1005Z0□72NTB	72	G、J、K	20	-	-	-	-	1.26	2	30
WQCW1005Z0□75NTB	75	G、J、K	20	-	-	-	-	1.62	2	50
WQCW1005Z0□82NTB	82	G、J、K	20	-	-	-	-	1.26	1.55	50
WQCW1005Z0□R10TB	100	G、J、K	20	-	-	-	-	1.16	2	30
WQCW1005Z0□R12TB	120	G、J、K	20	-	-	-	-	1.9	2.2	50

Tolerance : K : ±10%、J : ±5%、G : ±2%

TEMPERATURE RISE : Below 15°C at Rated Current

Operating Temperature Range. : -40°C ~ +125°C

Storage temperature Component: -40°C to +100°C. Tap e and reel packaging: -40°C to +80°C.

L AND Q MEASURED AN AGILENT 4291B IMPEDANCE ANALYZER WITH AN AGILENT/HP16193A TEST FIXTURE.

SRF MEASURED USING AN AGILENT/HP 5071C NETWORK ANALYZER AND A WTC TEST FIXTURE.

DCR MESASURED USING A MICRO-OHMMETER.

※MSL : LEVEL 1

RELIABILITY PERFORMANCE

Test Item	Test Condition	Standard Source
High Temperature Exposure (Storage)	1000 hrs. at rated operating temperature (e.g. 125°C part can be stored for 1000 hrs. @ 125°C. Same applies for 105°C and 85°C. Unpowered. Measurement at 24±4 hours after test conclusion.	MIL-STD-202 Method 108
Temperature Cycling	1000 cycles (-40°C to +125°C). Note: If 85°C part or 105°C part the 1000 cycles will be at that temperature. Measurement at 24±4 hours after test conclusion. 30min maximum dwell time at each temperature extreme. 1 min. maximum transition time.	JESD22 Method JA-104
Biased Humidity	1000 hours 85°C/85%RH. Unpowered. Measurement at 24±4 hours after test conclusion.	MIL-STD-202 Method 103
Operational Life	1000 hrs. @ 105°C . If 85°C or 125°C part will be tested at that temperature. Measurement at 24±4 hours after test conclusion.	MIL-PRF-27
Mechanical Shock	Method 213. Condition C, Peak Value: 100g's, Duration: 6ms, Waveform: Half-sine Velocity Change: 12.3ft/sec	MIL-STD-202 Method 213
Vibration	5g's for 20 minutes, 12 cycles each of 3 orientations. Note: Use 8"X5" PCB, .031" thick, 7 secure points on one long side and 2 secure points at corners of opposite sides. Parts mounted within 2" from any secure point. Test from 10-2000 Hz.	MIL-STD-202 Method 204
Resistance to Soldering Heat	Condition B No pre-heat of samples. Note: Single Wave Solder - Procedure 2 for SMD and Procedure 1 for Leaded with solder within 1.5mm of device body.	MIL-STD-202 Method 210
ESD	Passive Component Human Body Model (HBM) Electrostatic Discharge (ESD) Test. Only direct contact discharge, record the voltage value what the sample can pass.	AEC-Q200-002 Or ISO/DIS10605
Solderability	For both Leaded & SMD. Electrical Test not required. Magnification 50X. Conditions: Leaded: Method A @ 235°C, category 3. SMD: a) Method B, 4 hrs @ 155°C dry heat @ 235°C b) Method B @ 215°C category 3. c) Method D category 3 @ 260°C.	J-STD-002
Flammability	V-0 or V-1 Acceptable	UL-94
Board Flex	60 sec minimum holding time.	AEC-Q200-005
Terminal Strength (SMD)	Force of 450g for 60 seconds.	AEC-Q200-006

Typical RoHS Reflow Profile

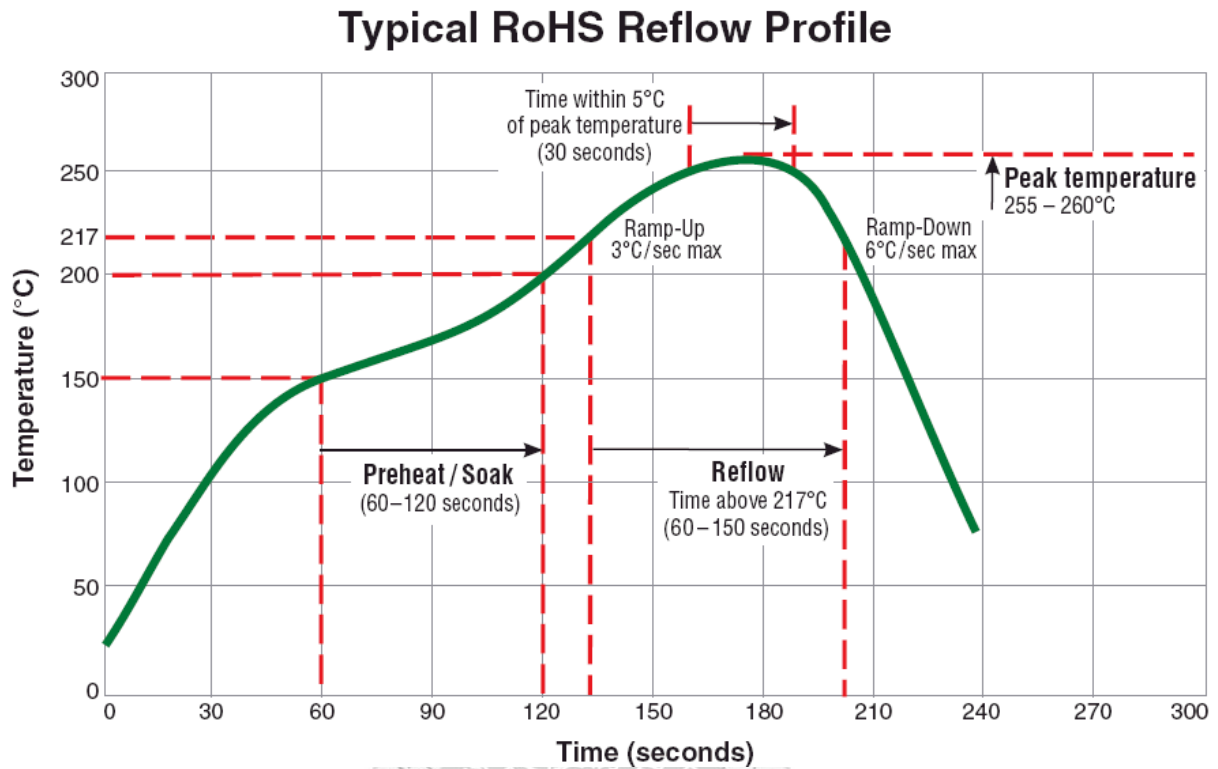

Packaging Specification

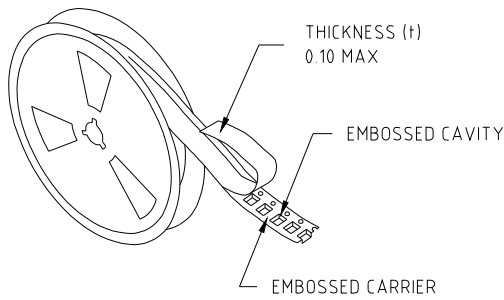

- THE FORCE FOR TEARING OFF COVER TAPE IS 10 TO 100 GRAMS IN THE ARROW DIRECTION.

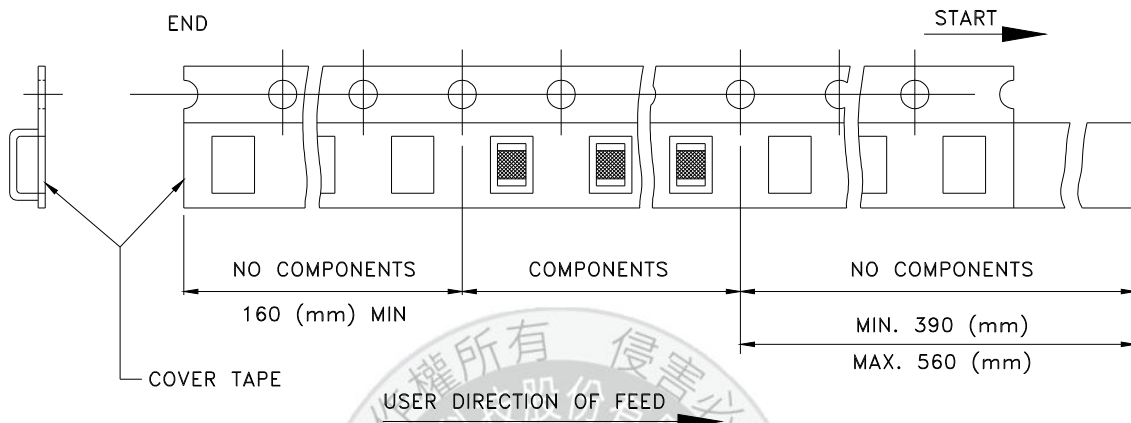
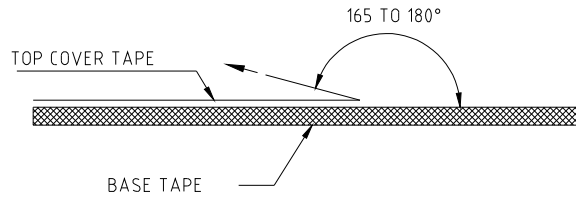

■ CARRIER TAPE REELS (mm)

MATERIAL: PAPER

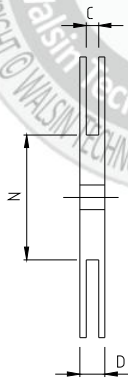
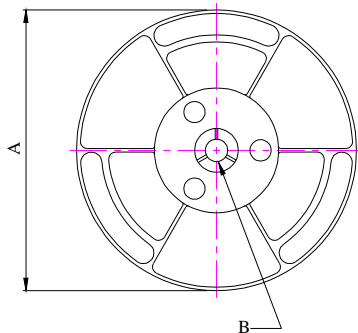

■ DIMENSIONS OF CARRIER TAPE (mm)

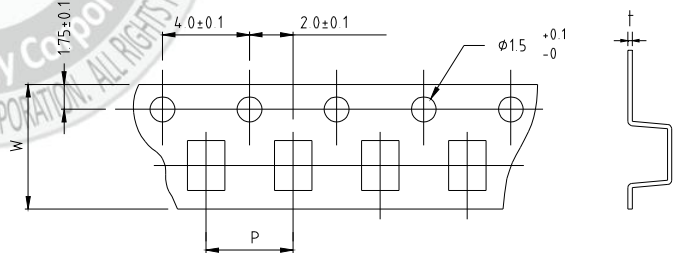

UNIT : mm

	A	B	C	D	N	P	W	t
DIM.	178	13.0	8.4	14.4	50	2.0	8.0	0.68
TOL.	MAX.	+0.5-0.2	+2.0-0	MAX	MIN.	±0.1	±0.2	±0.03

Quantity per reel : 4K pcs / reel