

SPECIFICATION

For

SWITCHING POWER SUPPLY

M/N: MPE-S155(-2) (24V / 6.25A)

Peak Power Enhanced Thin Model

Revision History

Version	Revise Date	Change Items
Rev. 01	Sep. 11. 2021	Established.
Rev. 02	Aug. 15. 2022	Added "UKCA" logo.
Rev. 03	Sep. 27. 2022	Added "MPE-S155-2" version.
Rev. 04	Feb. 01. 2024	Added "Typical" for Peak power 3.8s.
Rev. 05	May. 16. 2024	Changed Safety and removed "UKCA".

MPE-S155(-2)

150W AC / DC



FEATURES

- ✓ 200W Peak power for typical 3.8s.
- ✓ 150W fan cooling, 100W with convection-cooled.
- ✓ size 2 x 4 inch, height 1 inch.
- ✓ Wide operating temperature -20~80°C.
- ✓ High efficiency up to 90%.
- ✓ No-load power consumption < 0.1W.
- ✓ Class II, also class I with optional functional ground connected.
- ✓ ITE safety standard IEC 62368-1, UL 62368-1, CSA C22.2 No. 62368-1 CE LVD approved.
- ✓ Designed to meet IEC 60335-1, IEC 60601-1.
- ✓ Meets EMI CISPR / FCC class B.
- ✓ 5,000m operation altitude.



Models & Ratings

Model Number	Wattage (Rated / Max)	Output Voltage	Min. Current	Rated Current	Max. Current	Peak Current (for Typical 3.8s)
MPE-S155	100 W / 150 W	+24 V	0 A	4.17 A ^(Note1)	6.25 A ^(Note1)	8.33 A ^(Note1)

Output Power: 100W with convection cooling, 150W with 10.8 CFM at 50°C.

Note:

1. See the following performance curves for the detail.
2. Model no. coding:

MPE-S155-X

①

①

X=	Type
blank	General
-2	For customer with plastic case (Class II)

3. “General” for EMI Class I compliance, the primary & secondary YCAP grounding screw hole must be securely connected to the metal base.
4. “General” for EMI Class II compliance, the primary & secondary YCAP grounding screw hole must be securely connected.
5. For customer with plastic case version, the primary & secondary YCAP couldn't be connected by himself/herself, must purchase the “MPE-S155-2” version.

Input

Characteristic	Minimum	Typical	Maximum	Units	Notes & Conditions
Input Voltage	85	115 / 230	264	VAC	Continuous input range.
Input Frequency	47	60 / 50	63	Hz	AC input.
Input Current			3.0 / 1.8	A	Nominal AC Input Voltage (115VAC / 230VAC), Max load.
Inrush Current			30 / 60	A	Nominal AC Input Voltage (115VAC/230VAC), one cycle at 25°C cold start.
No-load power consumption			0.1	W	Nominal AC Input Voltage (230VAC/50Hz).
Switching Frequency		65		KHz	
Input Protection	One non-user serviceable internally located AC input line fuse. Fuse : 5A / 250VAC * 2pcs				

Output

Characteristic	Minimum	Typical	Maximum	Units	Notes & Conditions
Output Voltage		+24 V		Vdc	
Output Current		4.17	6.25	A	8.33A for peak current (Typical 3.8s).
Efficiency		90		%	At input 230VAC, rated load, above 1hr. warm up.
Initial Set Accuracy		±1.0		%	Initial setting accuracy is adjusted at input 115VAC and output at 60% rated load.
Minimum Load		0		A	
Start Up Delay		0.5		Sec	Time required for initial output voltage stabilization.
Hold Up Time		9 / 28		mS	Nominal AC Input Voltage (115VAC/230VAC), rated load.
Line Regulation		±0.5		%	Less than ±1% at rated load with ±10% changing in input voltage 115VAC.
Load Regulation		±1.0		%	Measured from 60% to 100% rated load and from 60% to 20% rated load (60% ±40% rated load).
Ripple & Noise			240 / 120	mV	Measured at rated load and Nominal AC Input Voltage (115VAC/230VAC) by a 20MHz bandwidth limited oscilloscope and the each output is connected with a 10µF Electrolytic Capacitor and a 0.1µF Ceramic Capacitor.
Leakage Current			100 / 300	uA	Functional Condition / Open Circuit Condition.
Overvoltage Protection	For some reason the power supply fails to control itself, the build-in over voltage protection circuit will Latch-off the outputs to prevent damaging external circuits, the trigger point is around 110%~130% of output voltage.				
Short Circuit Protection	Fully protected against output overload and short circuit. After short circuit protection or over current protection, PSU will auto recovery every 9 seconds. (Typical)				

Environmental

Characteristic	Minimum	Typical	Maximum	Units	Notes & Conditions
Operating Temperature	-20		+80	°C	See the following performance curves for the detail.
Storage Temperature	-40		+85	°C	
Relative Humidity	5		95	%RH	Non-condensing.
Cooling	10.8			CFM	Forced-cooled when 100W~150W
Operating Altitude		5000		m	

Derating curve

1. Output Power (W) versus Ambient Temp.(°C) Curve

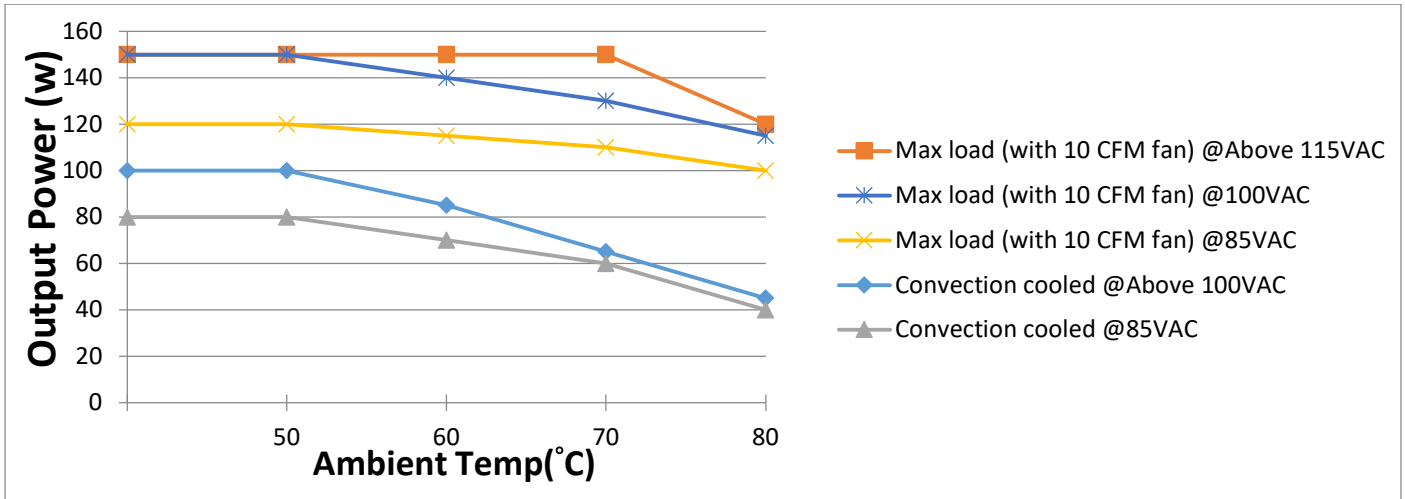

2. Output Power (W) versus Input Voltage(VAC) Curve

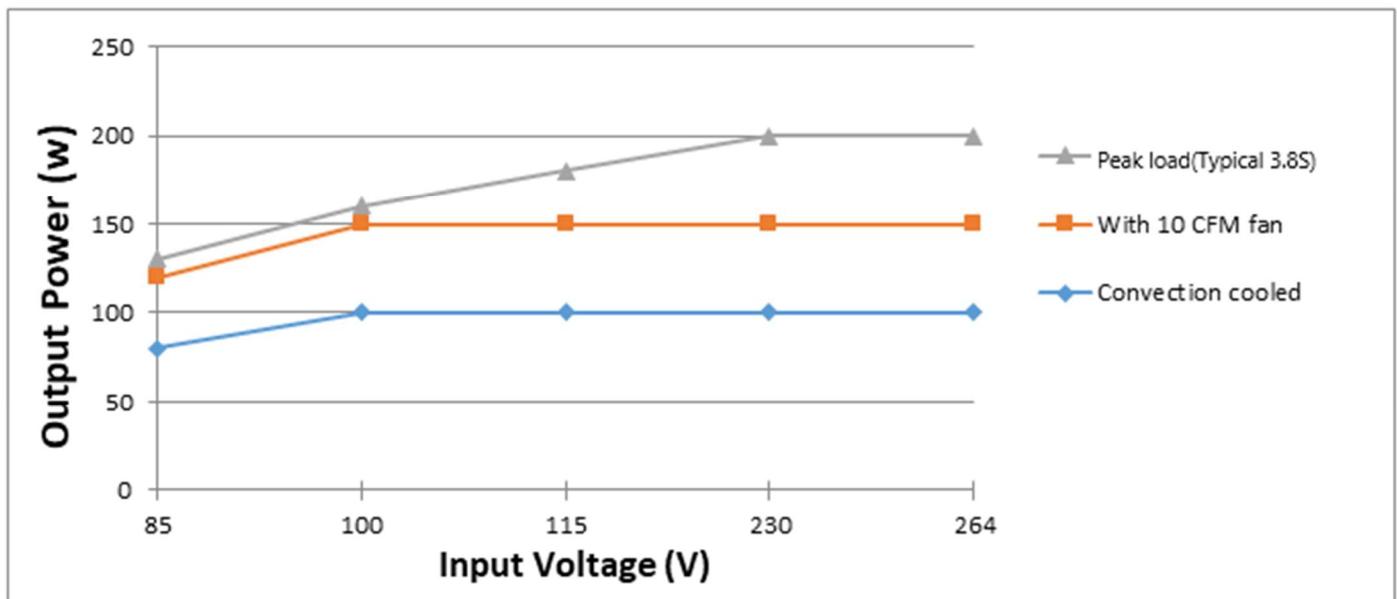

Note: If the operating temp exceeds 50°C, please refer to graph 1 for deration curve and according output proportion.

3. Low Temp cold Start (W) versus Input Voltage(VAC) Curve

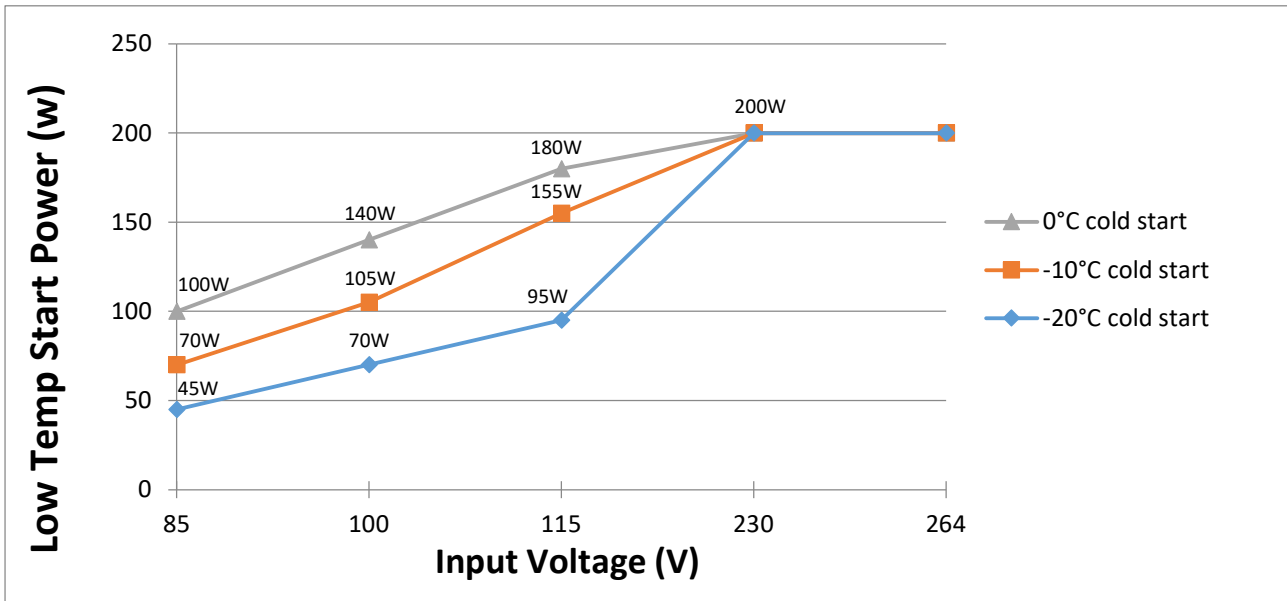

EMC: Emissions

Phenomenon	Standard	Class	Notes & Conditions
Conducted	EN 55022 / EN 55032, CISPR 22 & FCC Part 15	B	Mounting holes should be connected to Ground to conform the EMI limit (Class II refers to Note 1).
Radiated	EN 55022 / EN 55032, CISPR 22 & FCC Part 15	B	
Harmonic Current	EN 61000-3-2	A	AC Input : 230VAC, Load : 150W
Voltage Flicker	EN 61000-3-3	PASS	

Note:

- For Class II radiation, recommend to add a 4 turns core at input. (part#: EROCORE A81280200160)

EMC: Immunity

Phenomenon	Standard	Criteria	Notes & Conditions
ESD	IEC 61000-4-2	A	±15KV air discharge, ±8KV contact discharge
Radiated	IEC 61000-4-3	A	10V/m
EFT	IEC 61000-4-4	A	±2KV Line & PE
Surges	IEC 61000-4-5	A	L-N:±1KV, L/N-PE:±2KV
Conducted	IEC 61000-4-6	A	10V
Power Magnetic	IEC 61000-4-8	A	30A/m
Dips and Interruptions	IEC 61000-4-11	A / B A / B A / B B	DIP: >95%, 0.5 cycle DIP: 30%, 25 cycles ^(Note 2) DIP: 60%, 5 cycles ^(Note 2) INT: >95%, 250 cycles

Note:

- As a build-in type power supply, the power supply needs to be installed in a suitable enclosure to pass the EMI/EMC tests.
The final assembly has to comply with the valid EMI/EMC and safety.
- The test result of input 240Vac / 100Vac is criteria A / B.
- The mounting holes should be connected to each other to conform the EMI limit.

Safety Approvals

Characteristic	Minimum	Typical	Maximum	Units	Notes & Conditions
Isolation	IP to OP	4000		VAC	
	IP to GND	1800		VAC	
Safety Agency	Safety Standard				Notes & Conditions
TUV	EN 62368-1 2nd,3rd Edition				Approved.
	EN 60335-1				Designed to meet.
	EN 60601-1				Designed to meet.
CB	IEC 62368-1, 3rd Edition				Approved.
	IEC 60335-1				Designed to meet.
	IEC 60601-1				Designed to meet.
UL/cUL	UL 62368-1, 3rd Edition, CAN / CSA C22.2 No. 62368-1:19, 3rd Edition				Approved.
	UL 60335-1				Designed to meet.
	UL 60601-1				Designed to meet.

Mechanical Details

Unit: mm

SIZE : 101.6(L) x 50.8(W) x 25.4 mm, Tolerance +/-0.5mm.

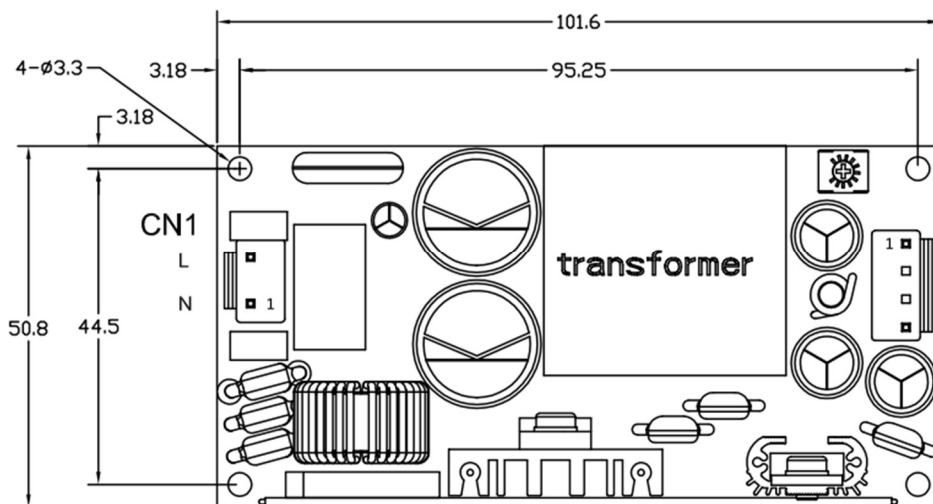
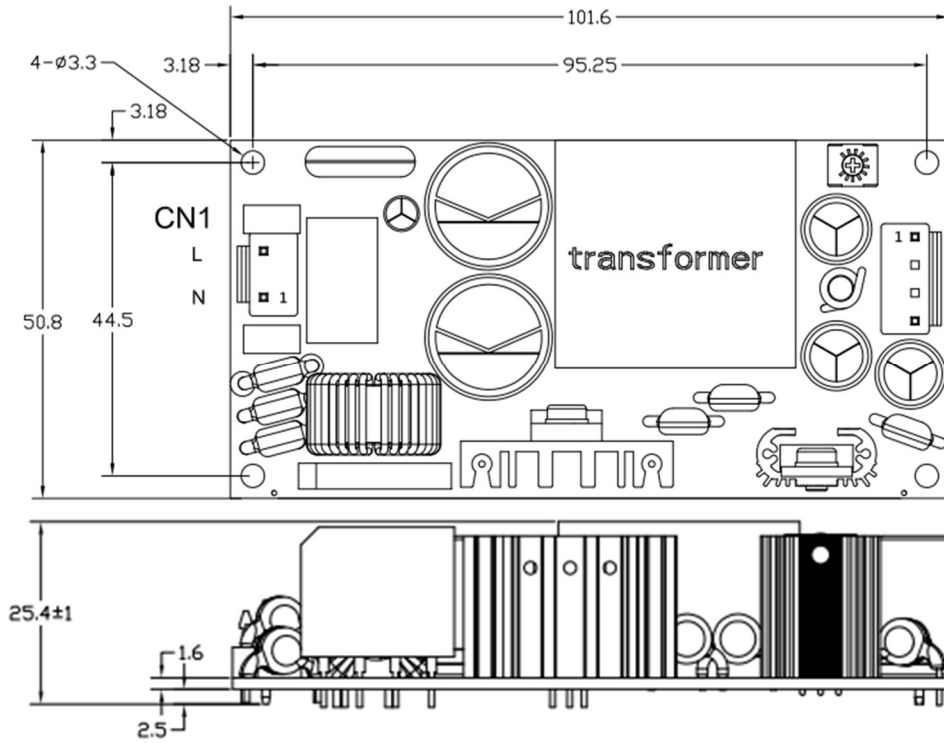

For customer with plastic case version, the primary & secondary YCAP couldn't be connected by himself/herself, must purchase the "MPE-S155-2" version.

Parameter	Conditions/Description				
Dimension	101.6 (L) x 50.8 (W) x 25.4 (H) mm, Tolerance +/- 0.5mm.				
Connector & Pin Assignment	Location	Pin (Note 1)	Assignment	Proposed Housing	Proposed Terminals
	CN1(Input) ST,B4P-VH-B(LF)(SN) or equivalent (remove the middle pin)	JT2	AC in (L)	JST: VHR-3N or equivalent	JST: SVH-21T-P1.1 or equivalent
		JT1	AC in (N)		
	CN2(Output) ST,B4P-VH-B(LF)(SN) or equivalent	JT4	0 V	JST: VHR-4N or equivalent	JST: SVH-21T-P1.1 or equivalent
JT3		0 V			
JT2		+ V			
JT1		+ V			

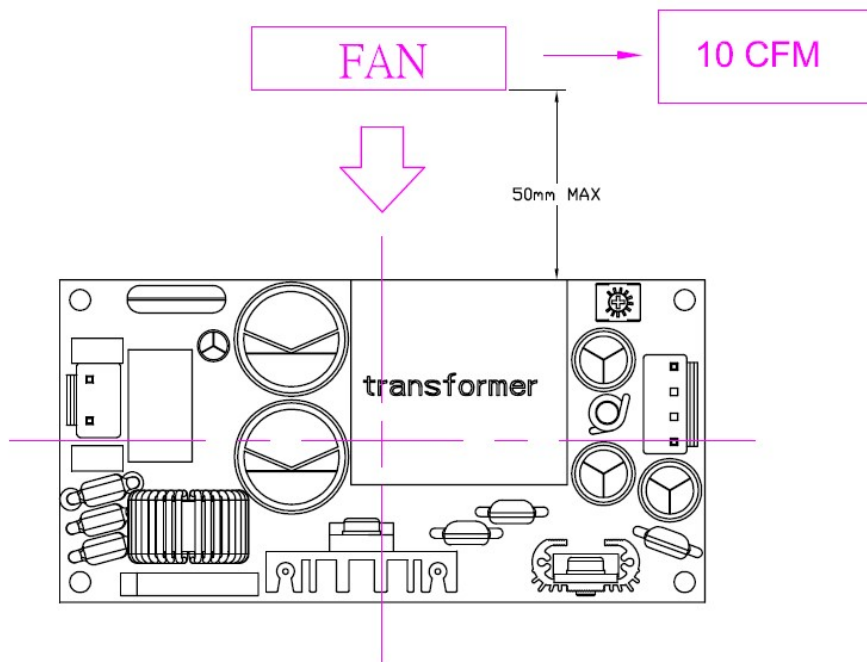

Thermal Considerations

In order to ensure safe operation of the PSU in the end-use equipment, the temperature of the components listed in the table below must not be exceeded.

Temperature should be monitored using J type thermocouples placed on the hottest part of the component (out of any direct air flow). See Mechanical Details for component locations.

Temperature Measurements at max. amb.	
Component	Max Temperature
T1	110°C
Q1	130°C
D9	130°C
C1B	105°C
C11A	105°C

Performance

(Input voltage: 115Vac)

Switching frequency ripple rated load

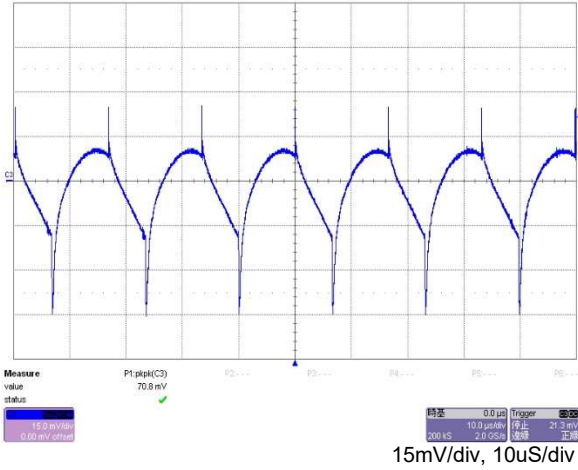

Line frequency ripple rated load

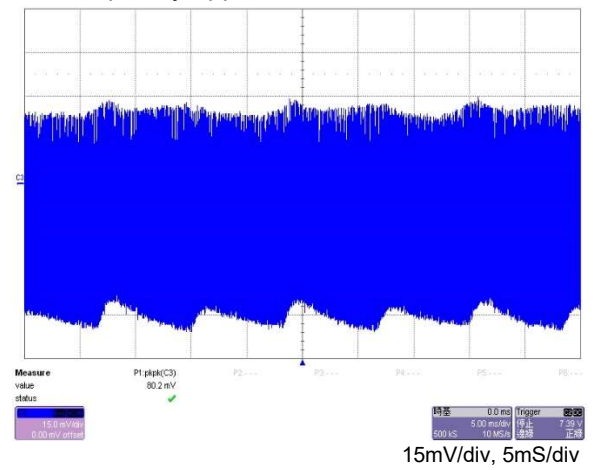

Output turn-on rated load

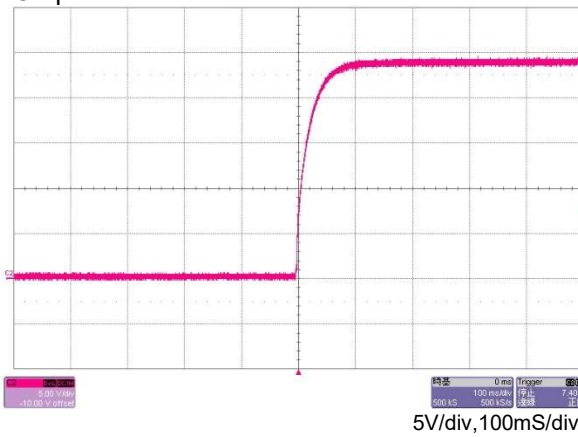

Output turn-off rated load

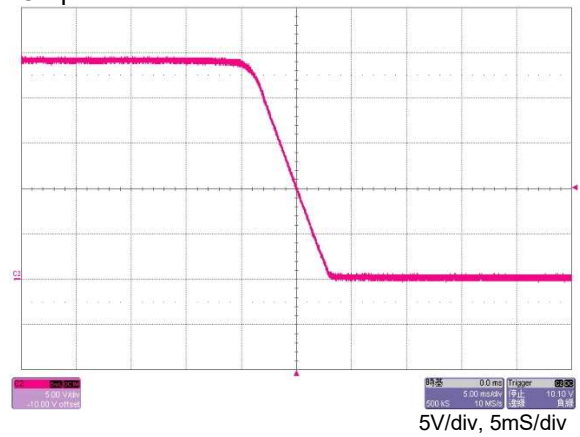

Hold-up time rated load

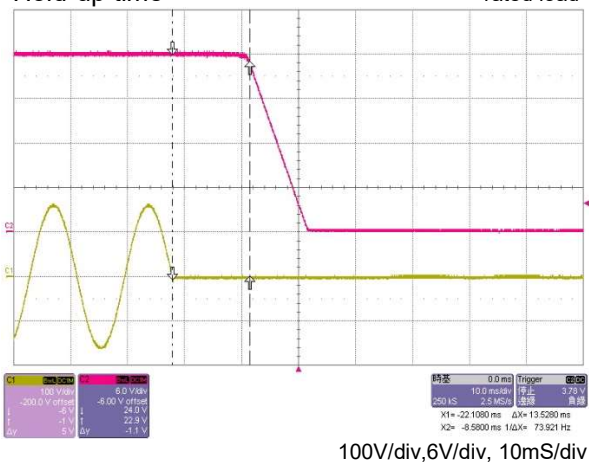

OVP 60% of rated load



Step response 20%~100% of rated load

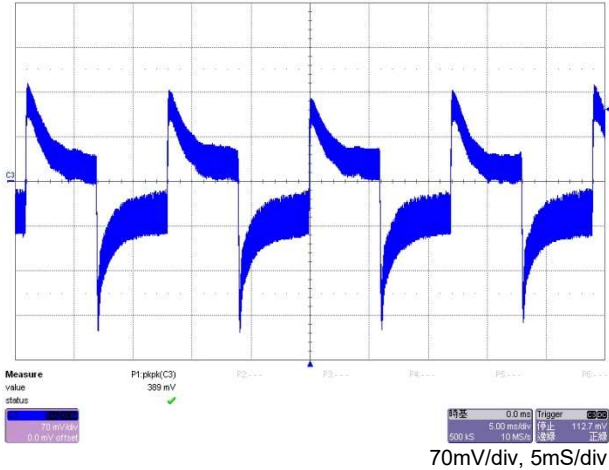

70mV/div, 5mS/div

EMI: EN 55032 "B" (Conduction)

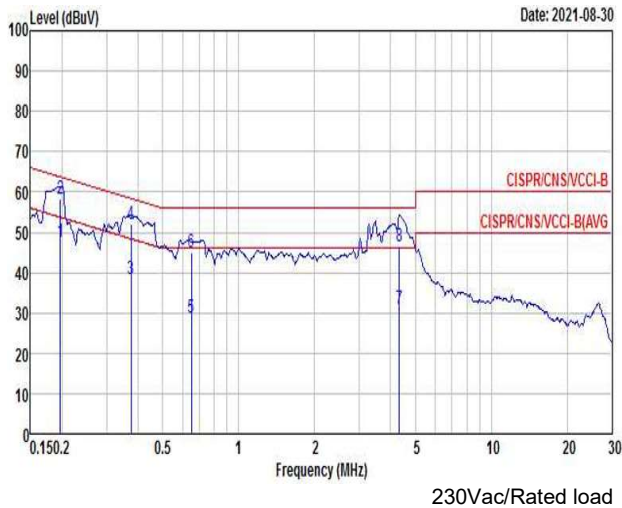

EMI: FCC "B" (Conduction)

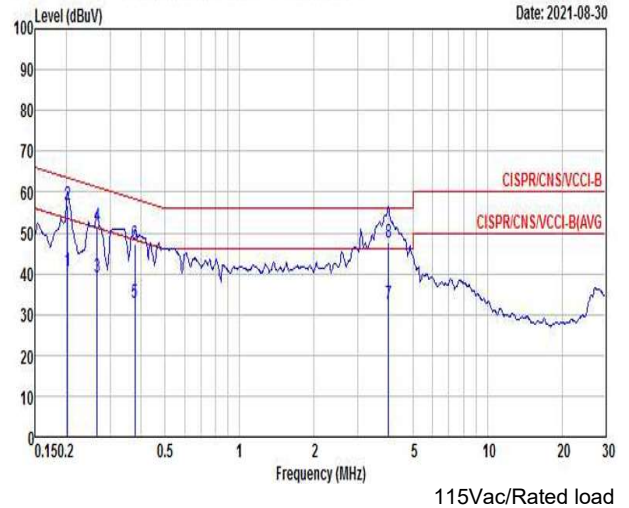

EMI: EN 55032 "B" (Radiation)

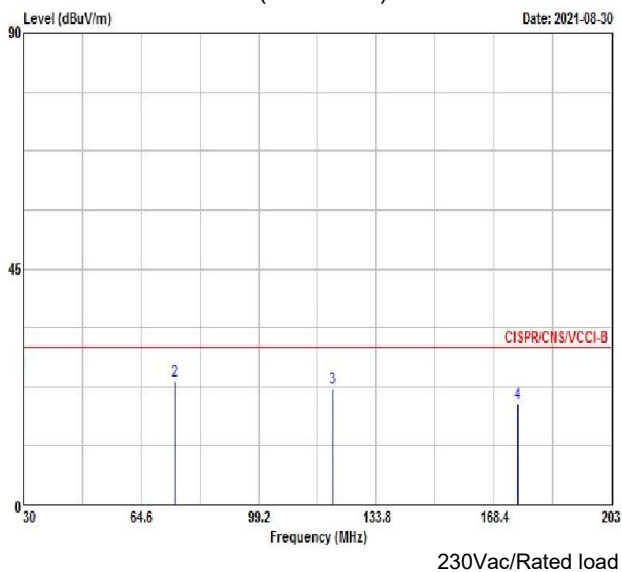

EMI: FCC "B" (Radiation)

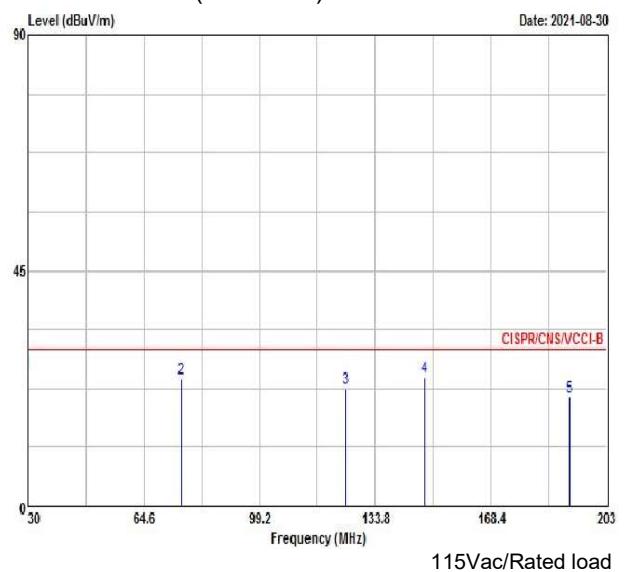

User manual

- Read this instruction carefully.
- Keep this equipment from humidity.
- The power supply shall be operated at a maximum ambient temperature as 50 °C
- The maximum output ratings as shown on the label shall not be exceeded.
- The transformer is not to be repaired and do not to be used any longer if it is damaged or defective.
- This SPS shall comply with the end-product standard after installation.
- Protection against access to primary live parts must be evaluated during end product evaluation.
- The power supply shall be fixed in end product.
- The end product shall be provided enough space to install this power supply.
- This SPS can be operated up to 5000 m altitude.
- This SPS shall be used in PD2 environment.
- The SPS is intended to be installed in the end product, the input and output wires cannot be touched by user after installation.
- An investigation of the protective bonding terminals has: Not been conducted, The Chassis shall be secured bonded to protective bonding terminal in the end-use product.
- Output (secondary) circuits are considered and evaluated as ES2 circuit, which separated from primary circuits by basic insulation
- When evaluating end product, the product needs to have the construction separated from ES2 circuits to ES1 circuits by basic insulation
- CAUTION: Double pole, neutral fusing. Disconnect mains before servicing.