

# ACE-series

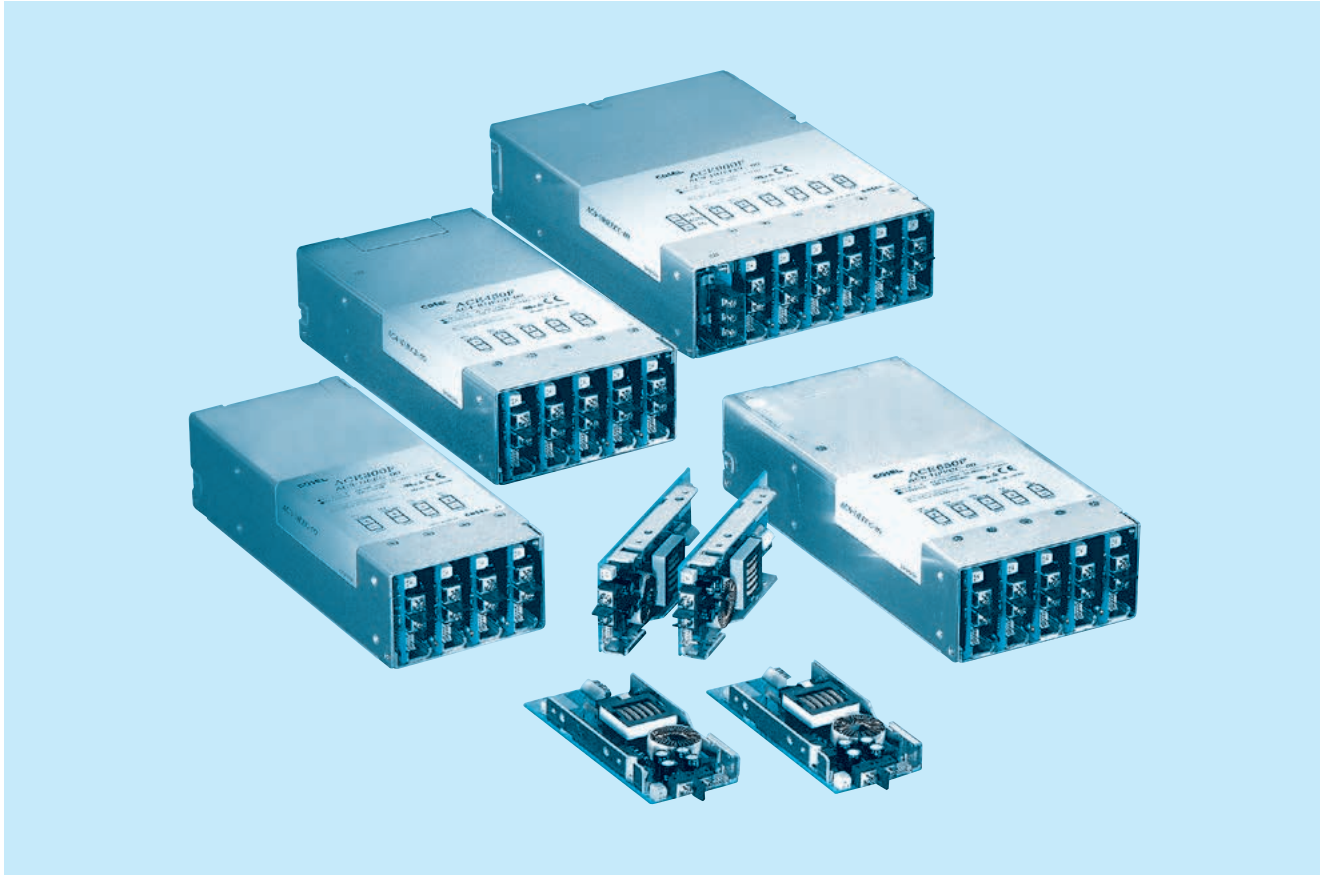

## ■ Feature

Flexible modular system architecture provides various output configuration  
 Harmonic attenuator (Complies with IEC61000-3-2)  
 Universal input (AC85 - 264V)  
 Remote ON/OFF control, alarm

## ■ Safety agency approvals

UL60950-1, C-UL (CSA60950-1), EN62368-1  
 Complies with DEN-AN  
 UL60601-1, C-UL (CSA601.1), EN60601-1 approvals (optional)

## ■ EMI

Complies with FCC-B, CISPR22-B,  
 EN55022-B, VCCI-B

## ■ 3-year warranty

## ■ CE marking

Low Voltage Directive  
 RoHS Directive

## ■ UKCA marking

Electrical Equipment Safety Regulations  
 RoHS Regulations

## ■ EMS Compliance : EN61204-3, EN61000-6-2

EN61000-4-2  
 EN61000-4-3  
 EN61000-4-4  
 EN61000-4-5  
 EN61000-4-6  
 EN61000-4-8  
 EN61000-4-11

IEC60601-1-2 (2014), EN60601-1-2 (2015) (optional)

# ACE series

AC  -       -  -

① ② ③ ④ ⑤ ⑥ ⑦ ⑧ ⑨ ⑩



Example recommended EMI/EMC filter  
 ACE300F NAC-06-472  
 ACE450F NAC-10-472  
 ACE650F NAC-20-472  
 ACE900F NAC-20-472



High voltage pulse noise type : NAP series  
 Low leakage current type : NAM series  
 \* A higher current rating EMI/EMC filter may be recommended in view of the other devices that could be connected in parallel with the power supply.

- ① Abbreviation type name of ACE series
- ② Abbreviation power of ACE series  
 3 : ACE300F  
 4 : ACE450F  
 6 : ACE650F  
 9 : ACE900F
- ③ Slot 6 Output module
- ④ Slot 5 Output module
- ⑤ Slot 4 Output module
- ⑥ Slot 3 Output module
- ⑦ Slot 2 Output module
- ⑧ Slot 1 Output module
- ⑨ Parallel code
- ⑩ Option (series code) \*8  
 Refer to instruction manual 6.1  
 Safety : UL60601-1, EN60601-1  
 Refer to instruction manual 8. for details.

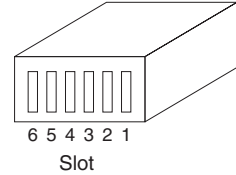

\* Make sure necessary tests will be carried out on your end equipment with the power supply installed in accordance with any required EMC/EMI regulations.

\* The number of slot is different depending on the model.  
 \* Empty slot is code:O

## SPECIFICATIONS

	MODEL	ACE300F	ACE450F	ACE650F	ACE900F	
INPUT	VOLTAGE[V]	AC85 - 264 1 φ / DC120 - 350 (option=-U AC70 or DC100 - refer to instruction manual 6)				
	FREQUENCY[Hz]	47 - 63				
	CURRENT[A]	AC100V *1	3.7typ	5.7typ	8.0typ	11typ
		AC200V *1	2.0typ	3.1typ	4.2typ	5.7typ
	POWER FACTOR	AC100V *1	0.99typ			
		AC200V *1	0.95typ			
	INRUSH CURRENT [A]	AC100V *2	15 / 30typ *7			15 / 50typ *7
		AC200V *2	30 / 30typ *7			30 / 50typ *7
	EFFICIENCY[%]	AC100V *1	74typ	75typ	77typ	77typ
		AC200V *1	78typ	78typ	80typ	80typ
LEAKAGE CURRENT[mA]	AC100V *3	0.5max				
	AC230V *3	0.95max				
OUTPUT	NUMBER OF SLOT	4	5	5	6	
	TOTAL OUTPUT[W]	AC90 - 150V *4	250	400	600	800 (Peak 1k)
		AC170 - 264V *4	300	450	650	900 (Peak 1k)
	START-UP TIME[ms]	500max (ACIN100V, Io=100%)				
	HOLD-UP TIME[ms] *1	20typ (ACIN100V, Io=100%)				
FUNCTION	AUXILIARY POWER (AUX)	12V 0.1A (Only for Remote ON/OFF) (option=-J 5V0.1A)				
	ALARM (PR)	FAN alarm, LINE alarm				
ISOLATION	INPUT-OUTPUT, RC, AUX	AC3,000V 1minute, Cutoff current=10mA, DC500V 50MΩ min (At Room Temperature)				
	INPUT-FG	AC2,000V 1minute, Cutoff current=10mA, DC500V 50MΩ min (At Room Temperature)				
	OUTPUT, RC, AUX(PR)-FG *5	AC500V 1minute, Cutoff current=100mA, DC500V 50MΩ min (At Room Temperature)				
ENVIRONMENT	OPERATING TEMP., HUMID. AND ALTITUDE *4	-20 to +70°C, 20 - 90%RH (Non condensing) 3,000m (10,000feet) max				
	STORAGE TEMP., HUMID. AND ALTITUDE	-20 to +75°C, 20 - 90%RH (Non condensing) 9,000m (30,000feet) max				
	VIBRATION	19.6m/s <sup>2</sup> (2G) , 10 - 55Hz, 3minutes period, 60minutes each along X, Y and Z axis				
	IMPACT	196.1m/s <sup>2</sup> (20G) , 11ms, once each X, Y and Z axis				
SAFETY AND NOISE REGULATIONS	AGENCY APPROVALS	UL60950-1, C-UL (CSA60950-1), EN62368-1, Complies with DEN-AN (At only AC input) UL60601-1, EN60601-1 (At only AC input), Complies with IEC60601-1-2 4th Ed. (Refer to instruction manual 8)				
	CONDUCTED NOISE	Complies with FCC-B, VCCI-B, CISPR22-B and EN55022-B				
	HARMONIC ATTENUATOR	Complies with IEC61000-3-2 *9				
OTHERS	CASE SIZE *6	103X63.5X254mm (W X H X D) [4.06 X 2.5 X 10 inches]	127X63.5X254mm (W X H X D) [5 X 2.5 X 10 inches]	127X63.5X279mm (W X H X D) [5 X 2.5 X 10.98 inches]	177.5X63.5X254mm (W X H X D) [6.99 X 2.5 X 10 inches]	
	WEIGHT[kg]	1.7max	2.2max	2.4max	3.0max	
	COOLING METHOD	Forced cooling (built-in)				

\*1 In case of modular power supply, the value changes by composing and load factor of installed output modules. The values in specifications mean each the model are composed of voluntary modules that are 5V (code : C), 12V (code : E), 24V (code : H) and the output power is total

output wattage under the prescribed conditions.  
 \*2 More than 3sec. to restart. Io=100%  
 \*3 Complies with IEC62368-1 and DEN-AN 60Hz and 100% load.  
 \*4 Refer to "Derating" in detail.  
 \*5 Each output module, RC and AUX are isolated.

\*6 Case size contains neither the terminal blocks, screw nor.  
 \*7 Primary inrush current / Secondary inrush current.  
 \*8 Please contact us about safety approvals for the model with option.  
 \*9 Please contact us about class C.  
 \* A sound may occur from power supply at pulse loading.

Output module specifications

ITEM	CODE	150W suitable single output										50W suitable single output					75W dual output						
		A	B	C	D	E	F	G	H	J	K	L	M	N	P	R	Y*7	W*7	Z*7	9*7			
Number of slots used		1	1	1	1	1	1	1	1	1	1	1	1	1	1	1	1	1	1	1			
VOLTAGE[V]		+2	+3.3	+5	+7.5	+12	+15	+18	+24	+34	+48	+3.3	+5	+12	+15	+24	±5	±12	±15	±24			
MINIMUM CURRENT[A]		0	0	0	0	0	0	0	0	0	0	0	0	0	0	0	0	0	0	0			
CURRENT1[A]		26	26	26	18	13	10	8.5	6.5	4.5	3.2	10	10	5	4	2.5	3	3.2	2.5	1.6			
CURRENT2[A]		—	—	—	—	—	—	—	—	—	—	—	—	—	—	—	7	4.2	3.5	2.5			
PEAK CURRENT[A]	*1	—	—	—	—	14	12	10	8	5.5	4	—	—	—	—	—	—	5	4	—			
LINE REGULATION[mV]max		20	20	20	36	48	60	72	96	120	192	20	20	48	60	96	20	48	60	60			
LOAD REGULATION1[mV]max*5		40	40	40	100	100	120	120	150	180	300	40	40	100	120	150	250	600	600	600			
LOAD REGULATION2[mV]max*6		—	—	—	—	—	—	—	—	—	—	—	—	—	—	—	500	750	750	750			
RIPPLE [mVp-p]max	0 to +50°C *2 -20 to 0°C *2	80 140	80 140	80 140	120 160	120 160	120 160	120 160	120 160	120 160	150 300	80 140	80 140	120 160	120 160	120 160	80 140	120 160	120 160	120 160			
RIPPLE NOISE [mVp-p]max	0 to +50°C *2 -20 to 0°C *2	120 160	120 160	120 160	150 180	150 180	150 180	150 180	150 180	150 180	350 400	120 160	120 160	150 180	150 180	150 180	120 160	150 180	150 180	150 180			
TEMPERATURE COEFFICIENT[mV]max	0 to +50°C	50	50	50	90	120	150	180	240	300	480	50	50	120	150	240	50	120	150	150			
DRIFT[mV]max	*3	20	20	20	36	48	60	72	96	120	192	20	20	48	60	96	20	48	60	60			
OUTPUT VOLTAGE SETTING[V]		2.00-2.20	3.25-3.45	4.99-5.30	7.20-7.80	11.5-12.5	14.4-15.6	17.3-18.7	23.0-25.0	33.0-35.0	46.0-50.0	3.25-3.45	4.99-5.30	11.5-12.5	14.4-15.6	23.0-25.0	4.99-5.30	11.5-12.5	14.4-15.6	23.0-25.0			
OUTPUT VOLTAGE ADJUSTMENT RANGE[V]	*4	1.60-2.60	2.60-3.60	4.00-5.50	6.00-8.20	9.00-13.2	13.2-16.5	16.5-19.2	19.2-26.4	27.2-37.4	38.4-52.8	2.60-3.60	4.00-5.50	9.00-13.2	13.2-16.5	19.2-26.4	4.99-6.00	9.60-13.2	13.2-16.5	19.2-26.4			
OVERCURRENT PROTECTION[A]		Works over 105%min of rated current or 101%min of peak current. Automatic recovery.																					
OVERVOLTAGE PROTECTION[V]		3.00-4.80	4.00-5.25	Works at 115 - 140% of rated voltage										4.00-5.25	Works at 115 - 140% of rated voltage					6.90-8.40	13.8-16.8	17.25-21.0	27.6-33.6
FUNCTION		Remotesensing, remote ON/OFF, alarm (LV)										Remote ON/OFF, alarm (LV)											

ITEM	CODE	300W suitable single output										100W insulation dual output						150W dual output		★	
		2A	2B	2C	2D	2E	2F	2G	2H	2J	2K	S*8	T*8	U*8	Q*7	V*7	I				
Number of slots used		2	2	2	2	2	2	2	2	2	2	1	1	1	1	1	1	1	1	1	
VOLTAGE[V]		+2	+3.3	+5	+7.5	+12	+15	+18	+24	+34	+48	V1:+5	V2:+5	V1:+5	V2:+12	V1:+5	V2:+24	±12	±15	Refer to instruction manual 7 Input.	
MINIMUM CURRENT[A]		0	0	0	0	0	0	0	0	0	0	0	0	0	0	0	0	0	0	0	
CURRENT1[A]		60	60	60	40	25	20	17	14	10	7	10	5	10	4.2	10	2.1	6.4	5.5	—	
CURRENT2[A]		—	—	—	—	—	—	—	—	—	—	—	—	—	—	—	—	8	7	—	
PEAK CURRENT[A]	*1	—	—	—	—	34	27	23	20	14	10	—	—	—	—	—	—	10	8	—	
LINE REGULATION[mV]max		20	20	20	36	48	60	72	96	120	192	20	20	20	48	20	96	48	60	—	
LOAD REGULATION1[mV]max*5		40	40	40	100	100	120	120	150	180	300	40	40	40	100	40	150	600	600	—	
LOAD REGULATION2[mV]max*6		—	—	—	—	—	—	—	—	—	—	—	—	—	—	—	—	750	750	—	
RIPPLE [mVp-p]max	0 to +50°C *2 -20 to 0°C *2	80 140	80 140	80 140	120 160	120 160	120 160	120 160	120 160	120 160	150 300	80 140	80 140	80 140	120 160	80 140	120 160	200	200	—	
RIPPLE NOISE [mVp-p]max	0 to +50°C *2 -20 to 0°C *2	120 160	120 160	120 160	150 180	150 180	150 180	150 180	150 180	150 180	350 400	120 160	120 160	120 160	150 180	120 160	150 180	230	230	—	
TEMPERATURE COEFFICIENT[mV]max	0 to +50°C	50	50	50	90	120	150	180	240	300	480	50	50	50	120	50	240	120	150	—	
DRIFT[mV]max	*3	20	20	20	36	48	60	72	96	120	192	20	20	20	48	20	96	48	60	—	
OUTPUT VOLTAGE SETTING[V]		2.00-2.20	3.25-3.45	4.99-5.30	7.20-7.80	11.5-12.5	14.4-15.6	17.3-18.7	23.0-25.0	33.0-35.0	46.0-50.0	4.99-5.30	4.99-5.30	4.99-5.30	11.5-12.5	4.99-5.30	15.0-26.4	11.5-12.5	14.4-15.6	—	
OUTPUT VOLTAGE ADJUSTMENT RANGE[V]		1.60-2.60	2.60-3.60	4.00-5.50	6.00-8.20	9.00-13.2	13.2-16.5	16.5-19.2	19.2-26.4	27.2-37.4	38.4-52.8	4.99-5.50	3.00-5.50	4.99-5.50	7.50-13.2	4.99-5.50	15.0-26.4	9.60-13.2	13.2-16.5	—	
OVERCURRENT PROTECTION[A]		Works over 105%min of rated current or 101%min of peak current. Automatic recovery.																			
OVERVOLTAGE PROTECTION[V]		3.00-4.80	4.00-5.25	Works at 115 - 140% of rated voltage										Remote ON/OFF						Same as W,Z	—
FUNCTION		Remotesensing, remote ON/OFF, alarm (LV)										Remote ON/OFF						Same as W,Z		—	

- \*1 Operating condition of peak current : Peak current is less than 10sec., duty is less than 35% and average current is less than rated current. (rated current2 at Module W, Z, 9, Q and V)
- \*2 Measured by 20MHz oscilloscope or Ripple-Noise meter (Equivalent to KEISOKU-GIKEN : RM101). Ripple and Ripple Noise is measured by using measuring board with capacitor of 22 μF within 150mm from output terminal.
- \*3 Drift is changed in DC output for an eight hour period after half-hour warm-up at 25°C, with the input voltage held constant at the rated input/output.
- \*4 When the output voltage of module A is used less than 2.0V, keep minimum output current 2.6A.
- \*5 It is a value from 0 to rated output current1. The current on non-measurement side is fixed.
- \*6 It is a value from 0 to rated output current2. The current on non-measurement side is fixed.
- \*7 The sum of +power and -power must be less than output power(Y:50W, W:76.8W, Z:75W, 9:76.8W, Q:153.6W, V:165W).

- \*8 Ratings of V2 can draw up to 50% of rated current at the time of 0A in load of V1. (Only module S,T,U refer to instruction manual 5 for details.)
- \* Each output of module Y,Z, 9, Q and V is a ground common type (not isolated),each output of module S,T and U is isolated.
- \* For ACE300F,450F and 650F , input and output terminals can be set at the same side if Input module (code:I) is installed instead of the most left module.
- \* Modules which can correspond to medical electrical equipment (UL2601-1, EN60601-1) are all modules except module S, T and U. Refer to instruction manual 8. for details.

Block diagram

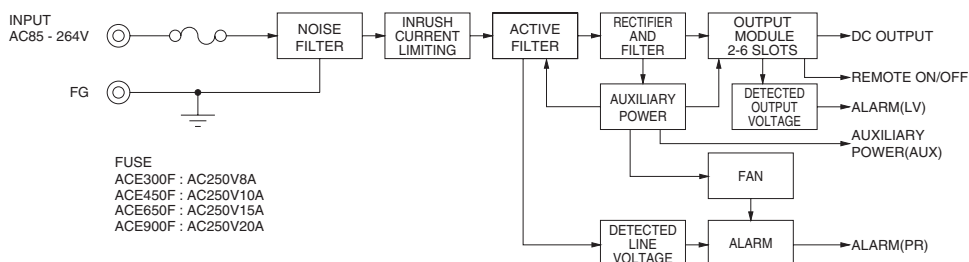

## ACE300F external view

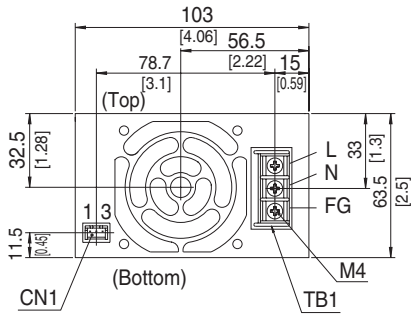

Pin connection and function of CN1

Pin No.	Function
1	G : Auxiliary power ground
2	PR : PR alarm
3	AUX : Auxiliary power (only remote ON/OFF)

Mating connector and terminal of CN1

Connector	Mating connector	Terminal	Mfr.
CN1	S3B-XH-A	XHP-3 Reel : SXH-001T-P0.6 Bulk : BXH-001T-P0.6	J.S.T.

- ※ Tolerance :  $\pm 1$  [ $\pm 0.04$ ]
- ※ Weight : 1.7kg max
- ※ PCB Material/thickness : FR-4 / 1.6mm [0.06]
- ※ Chassis material : Aluminium
- ※ Dimensions in mm, [ ]=inches
- ※ Mounting torque :  $1.2\text{N} \cdot \text{m}$  (12.8kgf · cm) max
- ※ Screw tightening torque M4 :  $1.6\text{N} \cdot \text{m}$  (16.9kgf · cm) max  
M3 :  $0.8\text{N} \cdot \text{m}$  (8.5kgf · cm) max

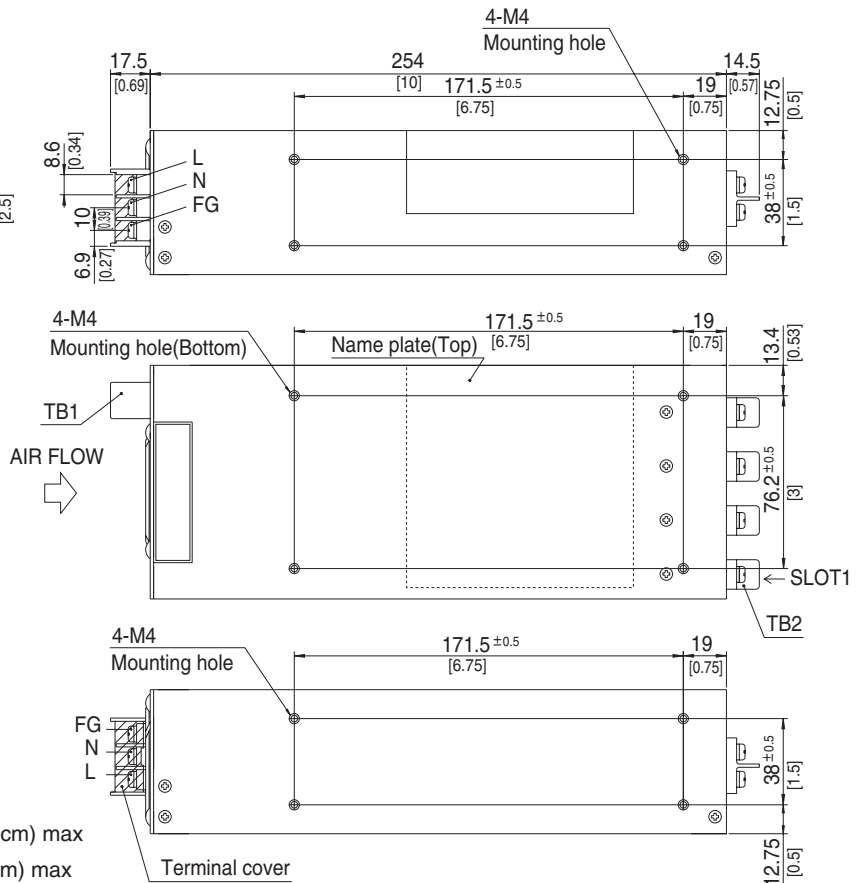

## ACE450F external view

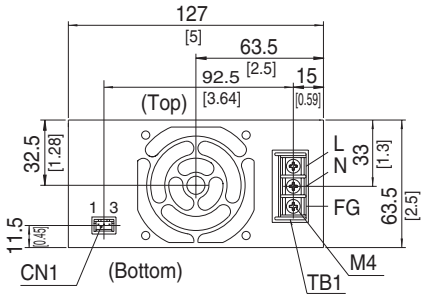

Pin connection and function of CN1

Pin No.	Function
1	G : Auxiliary power ground
2	PR : PR alarm
3	AUX : Auxiliary power (only remote ON/OFF)

Mating connector and terminal of CN1

Connector	Mating connector	Terminal	Mfr.
CN1	S3B-XH-A	XHP-3 Reel : SXH-001T-P0.6 Bulk : BXH-001T-P0.6	J.S.T.

- ※ Tolerance :  $\pm 1$  [ $\pm 0.04$ ]
- ※ Weight : 2.2kg max
- ※ PCB Material/thickness : FR-4 / 1.6mm [0.06]
- ※ Chassis material : Aluminium
- ※ Dimensions in mm, [ ]=inches
- ※ Mounting torque :  $1.2\text{N} \cdot \text{m}$  (12.8kgf · cm) max
- ※ Screw tightening torque M4 :  $1.6\text{N} \cdot \text{m}$  (16.9kgf · cm) max  
M3 :  $0.8\text{N} \cdot \text{m}$  (8.5kgf · cm) max

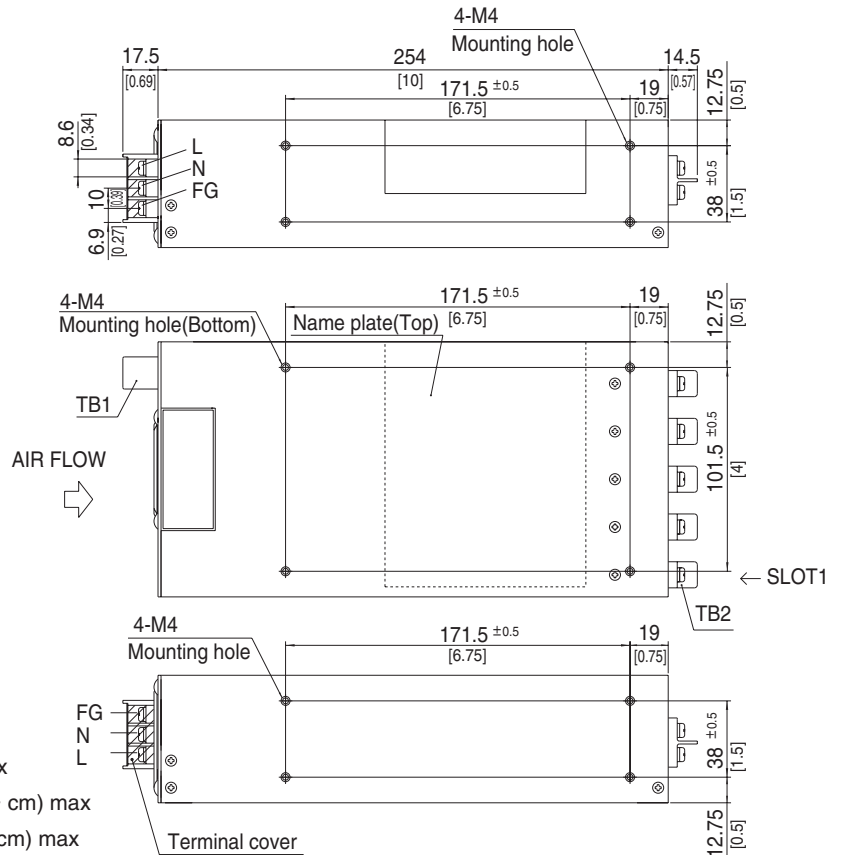

## ACE650F external view

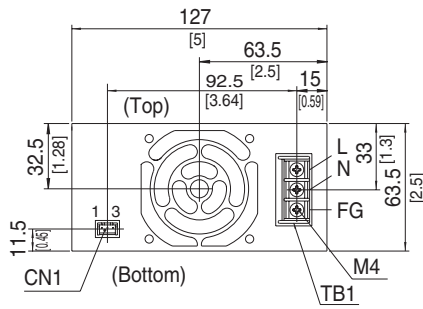

Pin connection and function of CN1

Pin No.	Function
1	G : Auxiliary power ground
2	PR : PR alarm
3	AUX : Auxiliary power (only remote ON/OFF)

Mating connector and terminal of CN1

Connector	Mating connector	Terminal	Mfr.
CN1	S3B-XH-A	XHP-3	J.S.T.
		Reel : SXH-001T-P0.6	
		Bulk : BXH-001T-P0.6	

- ※ Tolerance :  $\pm 1$  [ $\pm 0.04$ ]
- ※ Weight : 2.4kg max
- ※ PCB Material/thickness : FR-4 / 1.6mm [0.06]
- ※ Chassis material : Aluminium
- ※ Dimensions in mm, [ ]=inches
- ※ Mounting torque :  $1.2\text{N} \cdot \text{m}$  (12.8kgf · cm) max
- ※ Screw tightening torque M4 :  $1.6\text{N} \cdot \text{m}$  (16.9kgf · cm) max
- M3 :  $0.8\text{N} \cdot \text{m}$  (8.5kgf · cm) max

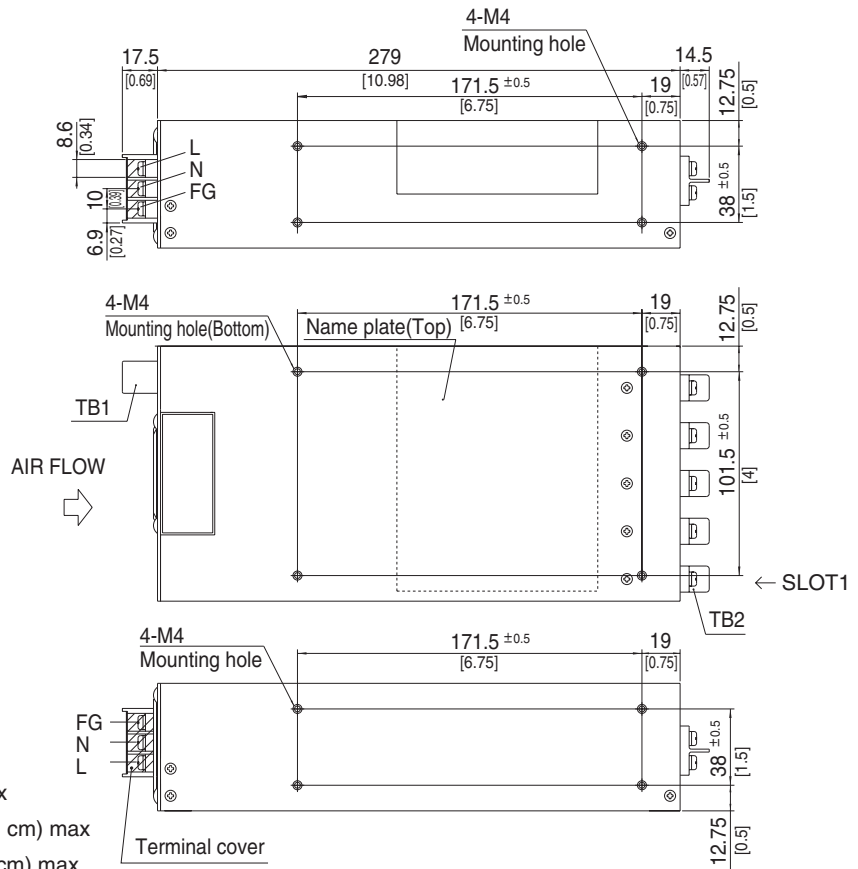

## ACE900F external view

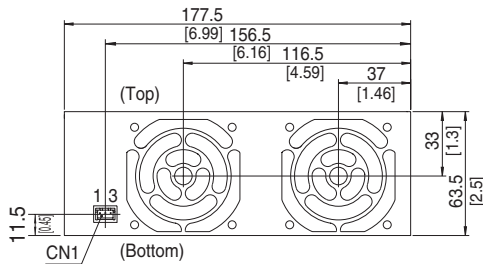

Pin connection and function of CN1

Pin No.	Function
1	G : Auxiliary power ground
2	PR : PR alarm
3	AUX : Auxiliary power (only remote ON/OFF)

Mating connector and terminal of CN1

Connector	Mating connector	Terminal	Mfr.
CN1	S3B-XH-A	XHP-3	J.S.T.
		Reel : SXH-001T-P0.6	
		Bulk : BXH-001T-P0.6	

- ※ Tolerance :  $\pm 1$  [ $\pm 0.04$ ]
- ※ Weight : 3kg max
- ※ PCB Material/thickness : FR-4 / 1.6mm [0.06]
- ※ Chassis material : Aluminium
- ※ Dimensions in mm, [ ]=inches
- ※ Mounting torque :  $1.2\text{N} \cdot \text{m}$  (12.8kgf · cm) max
- ※ Screw tightening torque M4 :  $1.6\text{N} \cdot \text{m}$  (16.9kgf · cm) max
- M3 :  $0.8\text{N} \cdot \text{m}$  (8.5kgf · cm) max

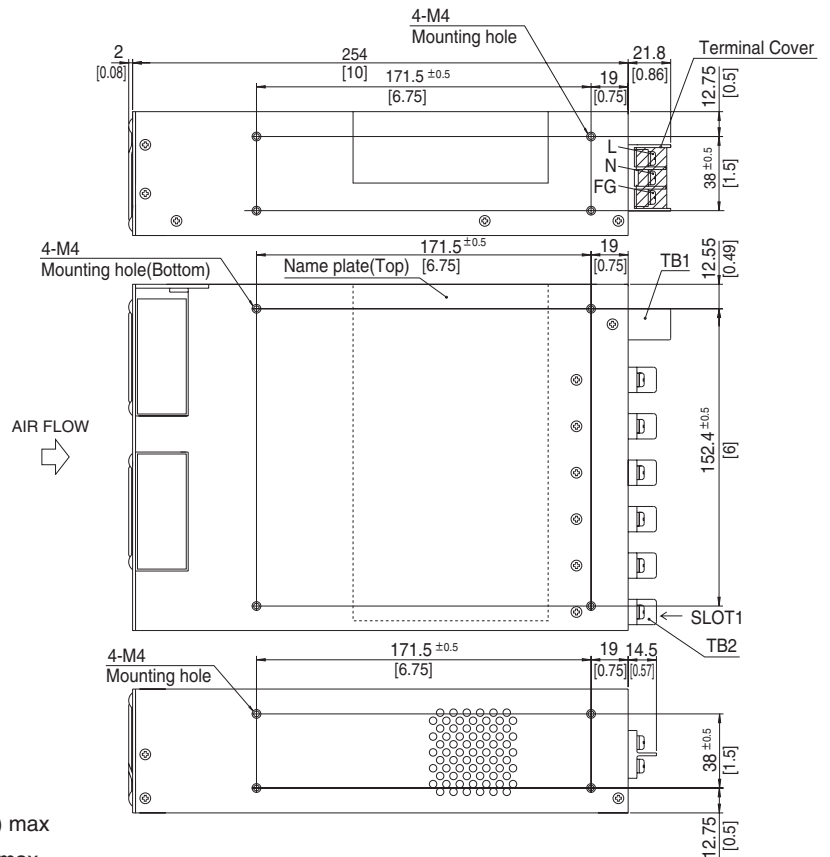



## Output module and connector pin assign

### 1. Output side view

ACE300F Output side view

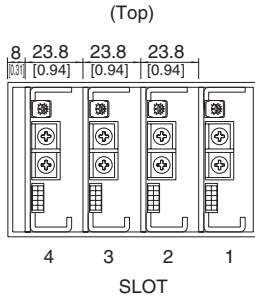

ACE450F/650F Output side view

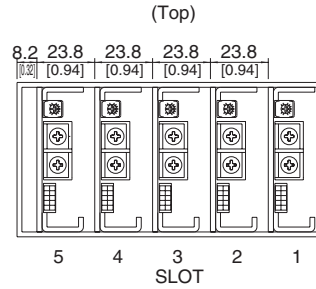

ACE900F Output side view

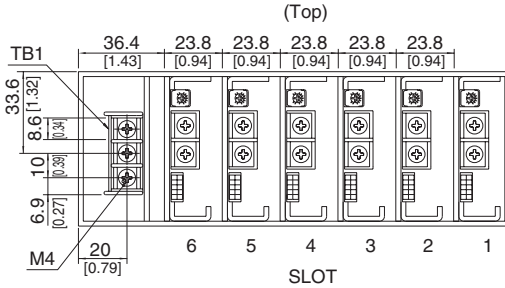

※Tolerance :  $\pm 1$  [ $\pm 0.04$ ]  
 ※Dimensions in mm, [ ] =inches

### 2. Output module side view and connector pin assign

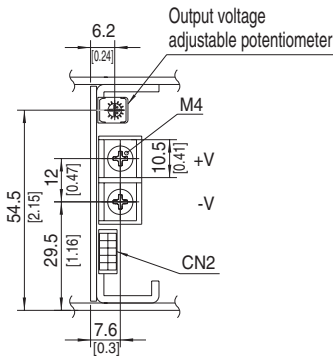

Module : A-K,L,M,N,P,R

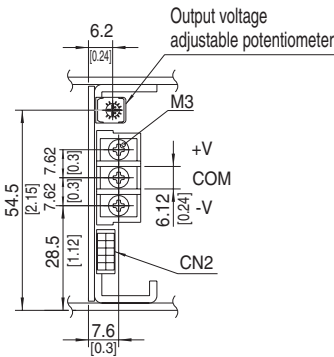

Module : Y,W,Z,9,Q,V

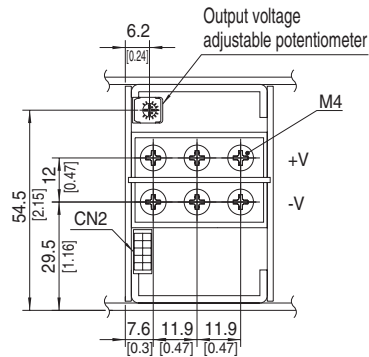

Module : 2A-2K

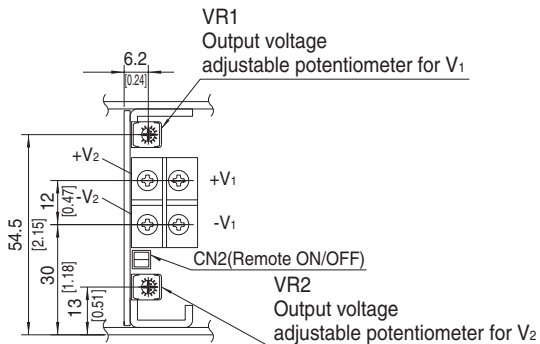

Module : S,T,U

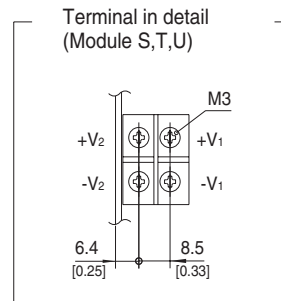

※Tolerance :  $\pm 1$  [ $\pm 0.04$ ]  
 ※Dimensions in mm, [ ] =inches

Output module and connector pin assign

●CN2 connector pin assign except module S,T,U

Mating connector and terminal of CN2 in Output Module

Connector	Mating connector	Terminal	Mfr.
CN2	S10B-PHDSS	PHDR-10VS	Chain : SPHD-002T-P0.5
			Loose : BPHD-001T-P0.5 BPHD-002T-P0.5 *1
			J.S.T.

※ The housing for the remote sensing unused is mounted on CN2 of each output module(applying module : A - K,2A - 2K).

\*1 Please consult J.S.T for a non-standard crimping tool.

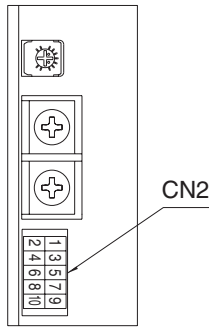

Pin connection and function of CN2 in Output Module

Pin No.	Function	
	Applying module : A - K,2A - 2K	Applying module : L,M,N,P,R,Y,W,Z,9,Q,V
1	RC+ : Remote ON/OFF +	RC+ : Remote ON/OFF +
2	RC- : Remote ON/OFF -	RC- : Remote ON/OFF -
3	N/C : N.C.	N/C : N.C.
4	N/C : N.C.	N/C : N.C.
5	LV+ : LV alarm	LV+ : LV alarm
6	LV- : LV alarm ground	LV- : LV alarm ground
7	+M : Self sensing terminal. (Do not wire for external connection.)	N/C : N.C.
8	+S : + Remote sensing	N/C : N.C.
9	-M : Self sensing terminal. (Do not wire for external connection.)	N/C : N.C.
10	-S : - Remote sensing	N/C : N.C.

●CN2 connector pin assign of module S,T,U

Mating connector and terminal of CN2 in Output Module

Connector	Mating connector	Terminal	Mfr.
CN2	S2B-PH-K-S	PHR-2	Chain:SPH-002T-P0.5S
			Loose:BPH-002T-P0.5S
			J.S.T.

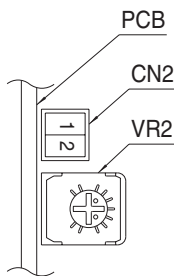

Pin connection and function of CN2 in Output Module

Pin No.	Function
1	Remote ON/OFF +
2	Remote ON/OFF -

Assembling and Installation Method

Installation method

- Fans for forced air cooling are built in.  
Ensure that the inlet (rear) and outlet (output terminal) vents are not blocked, to prevent disruption of the airflow.  
\*Option with reversed airflow (-F) is also available.
- If the unit is used in a dusty environment, an air filter should be used so the cooling efficiency of the fan is not reduced.
- If the fan stops, the thermal protection may be activated, shutting down the output. Life expectancy of the fan varies depending on usage conditions; therefore regular inspections of the fan are required for increased reliability. Should the fan become non-operational over the course of time, it can be replaced. Refer to the optional parts section of this catalog.
- When mounting the power supply with screws, it is recommended that this be done as shown in right figure. If other methods are used, be sure the weight of the power supply is taken into account.
- Avoid installation method 2 as shown in Fig. D, which can cause stress on the mounting holes.
- Maximum length of mounting screws is 6mm (Refer to right figure.).

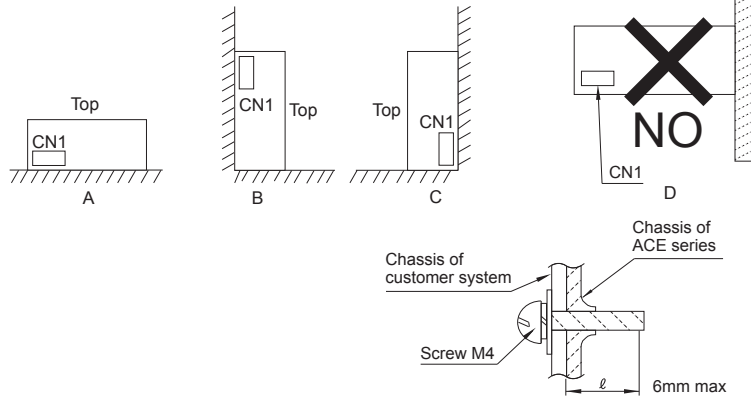
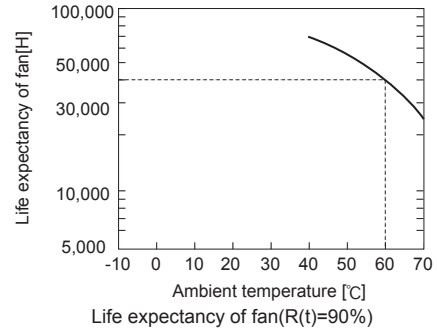

Derating

- The ACE series comprises power supplies consisting of a combination of output modules. Make sure each output module is used within specifications, and that the total output power of all modules is equal to, or less than the rated total output power.  
Refer to instruction manual 5 for Definition of load factor.

Derating curve for input voltage

● ACE300F

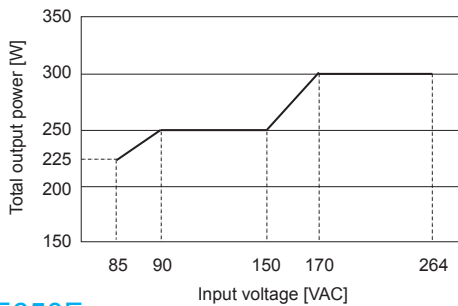

● ACE450F

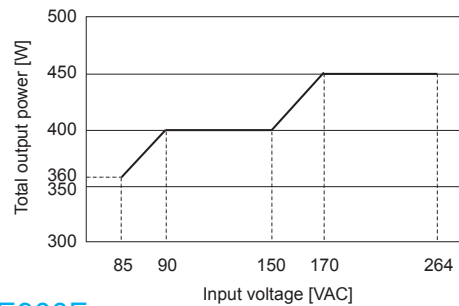

● ACE650F

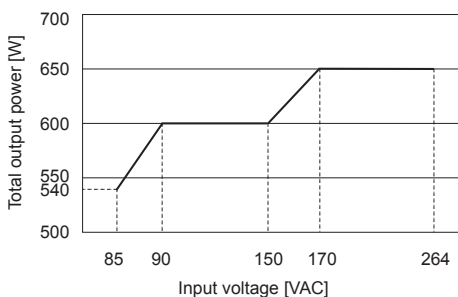

● ACE900F

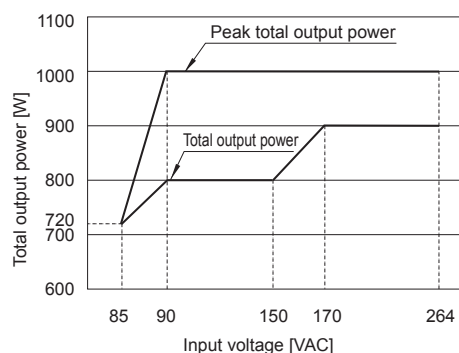

\*Refer to instruction manual 4 for Peak total output power.



Derating

Ambient temperature derating

- The derating curve for the ambient temperature (inlet temperature for cooling) of output modules is shown in right figure.
- Operation within the hatched area will result in different ripple and ripple noise specifications.

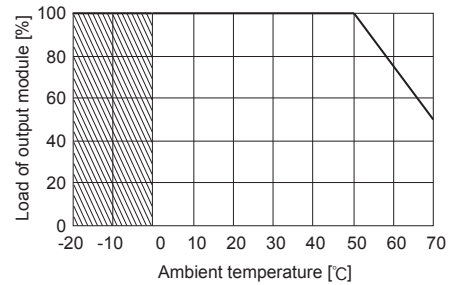

Instruction Manual

- ◆ It is necessary to read the "Instruction Manual" and "Before using our product" before you use our product.

Instruction Manual <https://www.cosel.co.jp/redirect/catalog/en/ACE/>  
 Before using our product <https://en.cosel.co.jp/technical/caution/index.html>

ACE



NOTICE



Basic Characteristics Data

Model	Circuit method	Switching frequency [kHz]	Input current [A]	Rated input fuse	Inrush current protection	PCB/Pattern			Series/Parallel operation availability	
						Material	Single sided	Double sided	Series operation	Parallel operation
Input module of ACE300F	Active filter	80	3.7*1	250V 8A	SCR	FR-4		Yes	No	No
Input module of ACE450F	Active filter	80	5.7*2	250V 10A	SCR	FR-4		Yes	No	No
Input module of ACE650F	Active filter	80	8.0*3	250V 15A	SCR	FR-4		Yes	No	No
Input module of ACE900F	Active filter	80	11*4	250V 20A	SCR	FR-4		Yes	No	No
Output module A-K	Forward converter	120	-	-	-	FR-4		Yes	Yes*5	Yes*7
Output module 2A-2K	Forward converter	120	-	-	-	FR-4		Yes	Yes*5	Yes*7
Output module L,M,N,P,R	Forward converter	120	-	-	-	FR-4		Yes	Yes*5	No
Output module Y,W,Z,9,Q,V	Forward converter	120	-	-	-	FR-4		Yes	Yes*6	No
Output module S,T,U	Forward converter	120	-	-	-	FR-4		Yes	Yes*6	No

\*1 Input current is based on Model AC3-HHECC-00 outputs 250W at AC100V.  
 \*2 Input current is based on Model AC4-HHECC-00 outputs 400W at AC100V.  
 \*3 Input current is based on Model AC6-HHECC-00 outputs 600W at AC100V.  
 \*4 Input current is based on Model AC9-HHECC-00 outputs 800W at AC100V.  
 \*5 Series operation is possible with the same output modules.  
 \*6 Series operation is possible, but series bar cannot be set by the series code.  
 \*7 Parallel operation is possible with the same output voltage module.

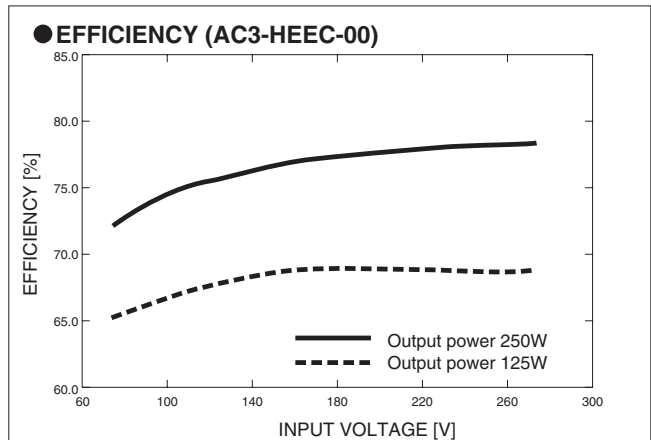
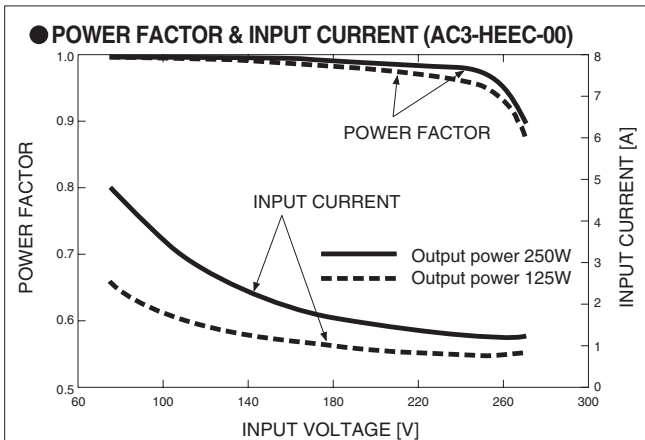
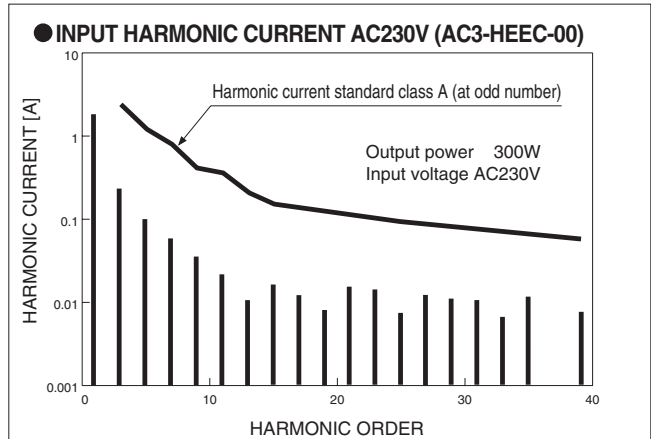
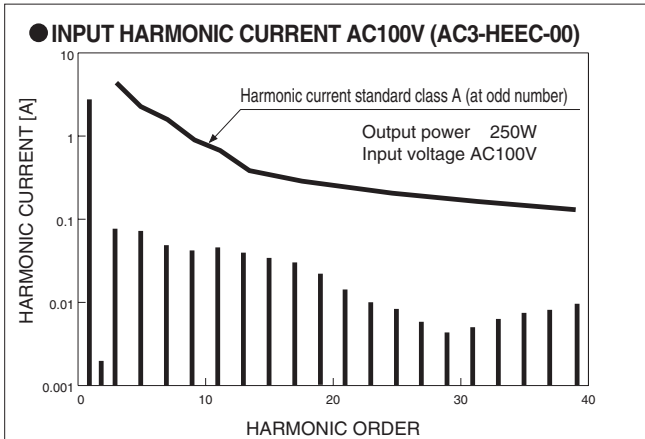
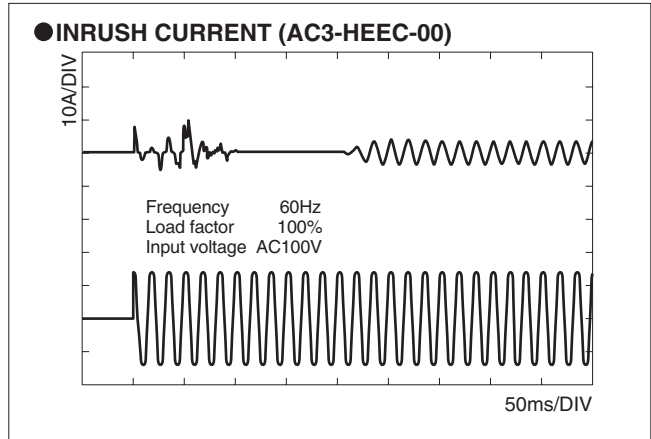
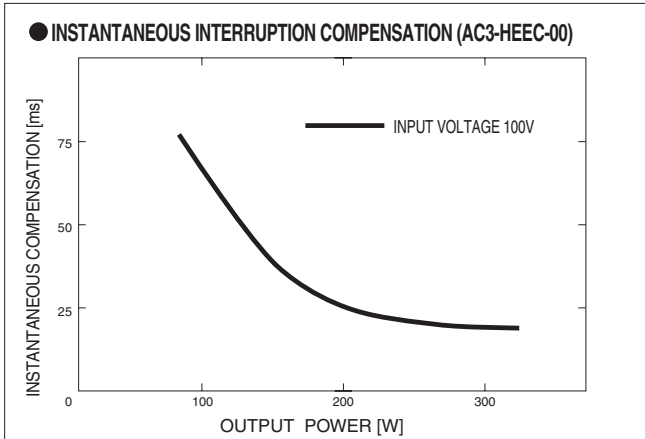
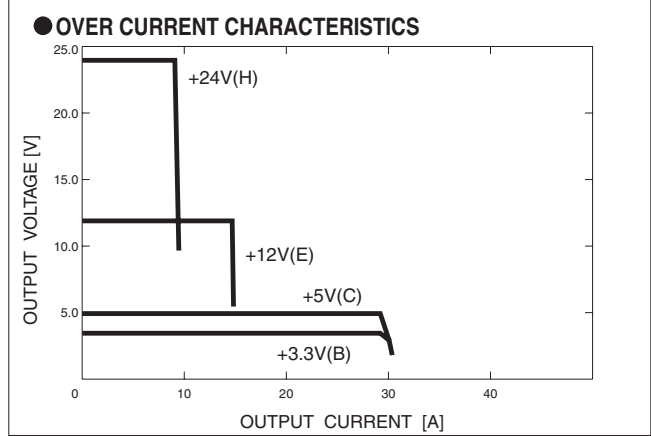
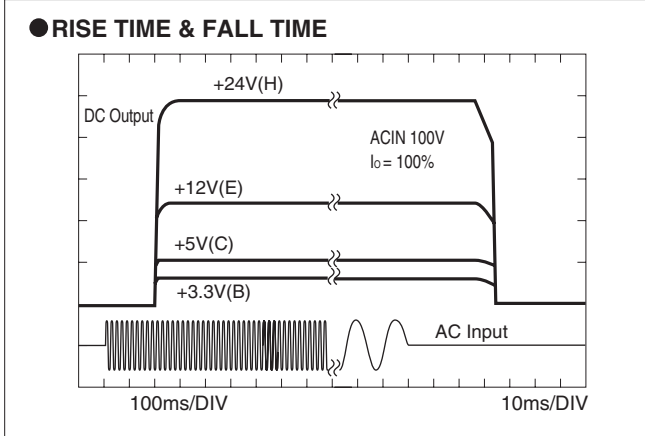

● RISE TIME & FALL TIME

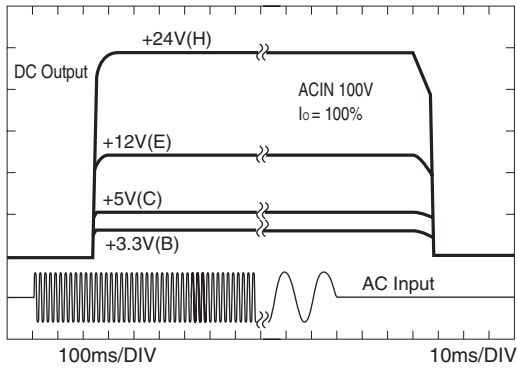

● OVER CURRENT CHARACTERISTICS

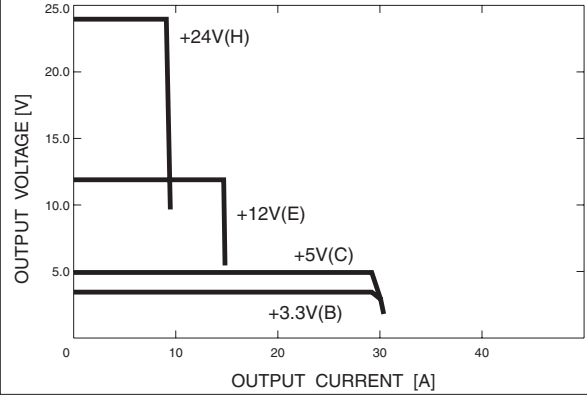

● INSTANTANEOUS INTERRUPTION COMPENSATION (AC4-HHECC-00)

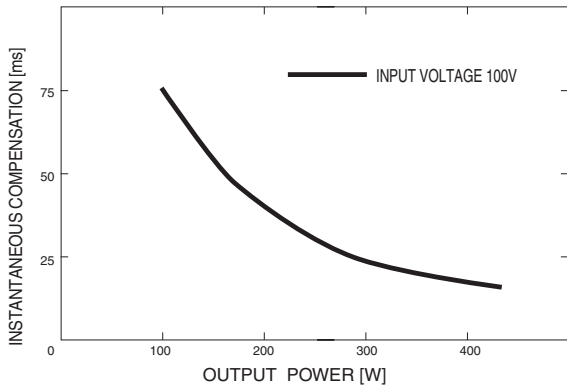

● INRUSH CURRENT (AC4-HHECC-00)

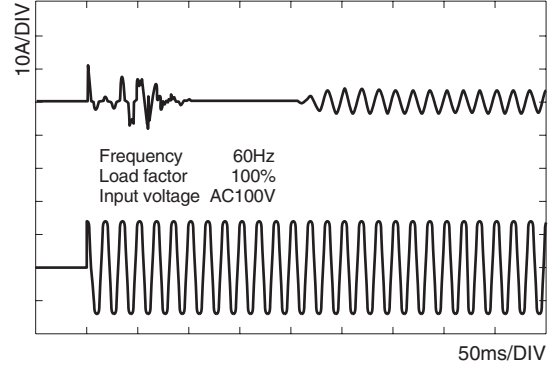

● INPUT HARMONIC CURRENT AC100V (AC4-HHECC-00)

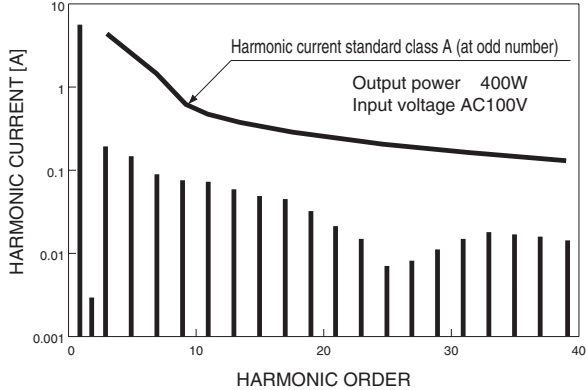

● INPUT HARMONIC CURRENT AC230V (AC4-HHECC-00)

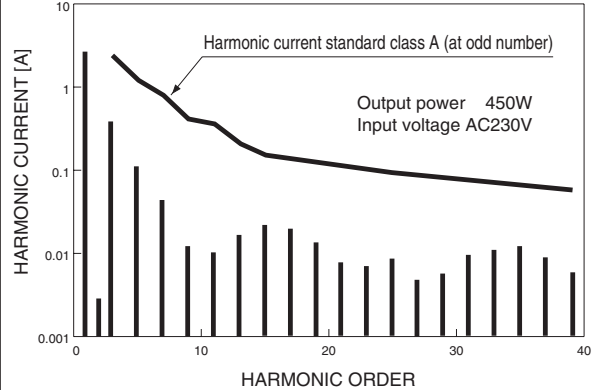

● POWER FACTOR & INPUT CURRENT (AC4-HHECC-00)

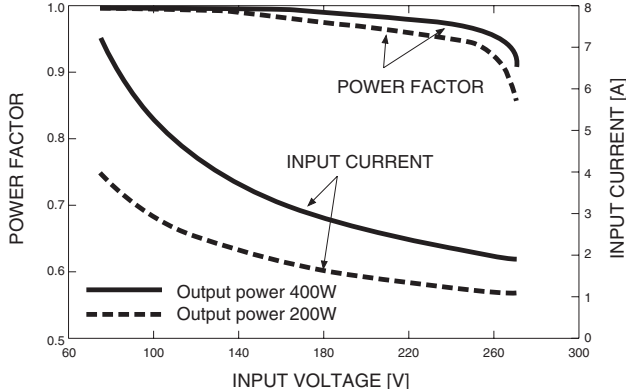

● EFFICIENCY (AC4-HHECC-00)

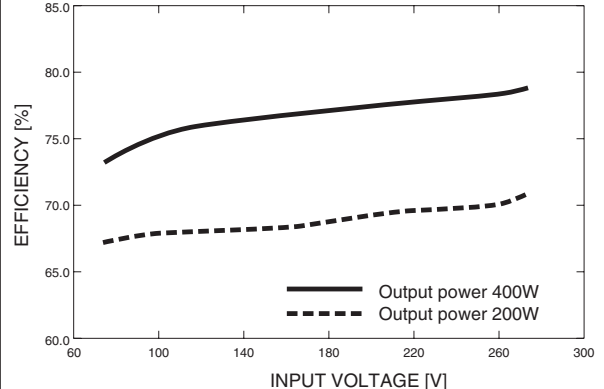

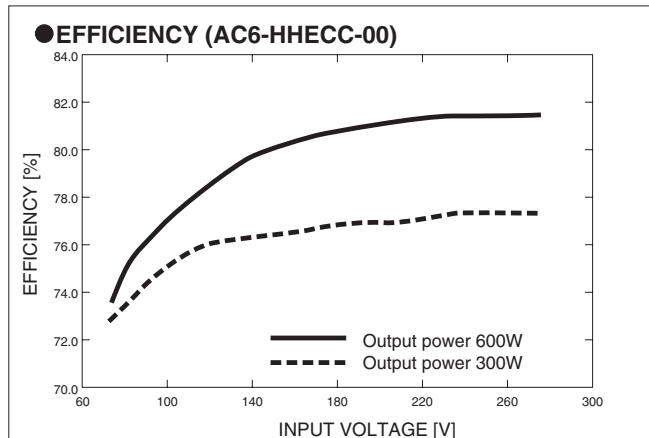
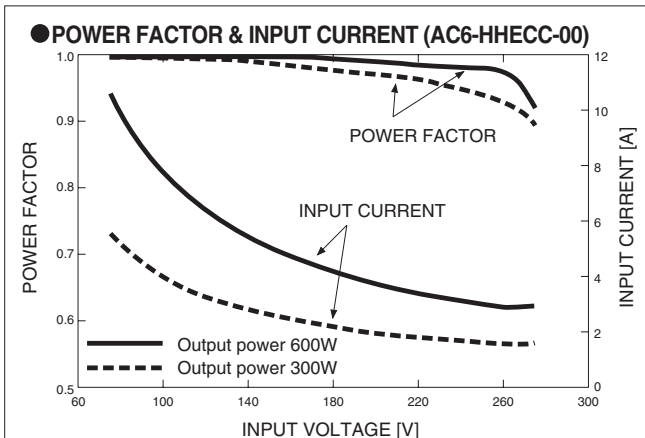
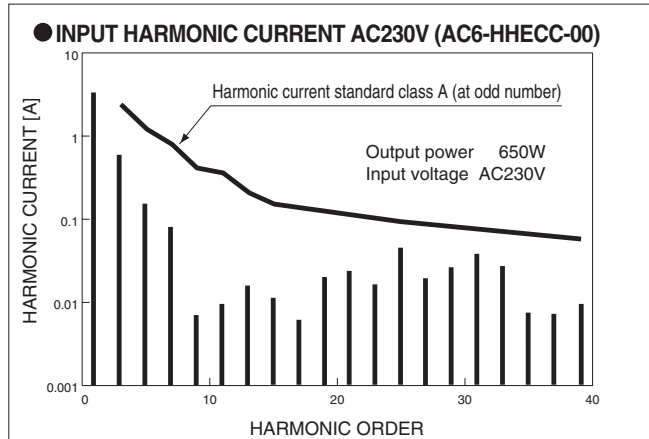
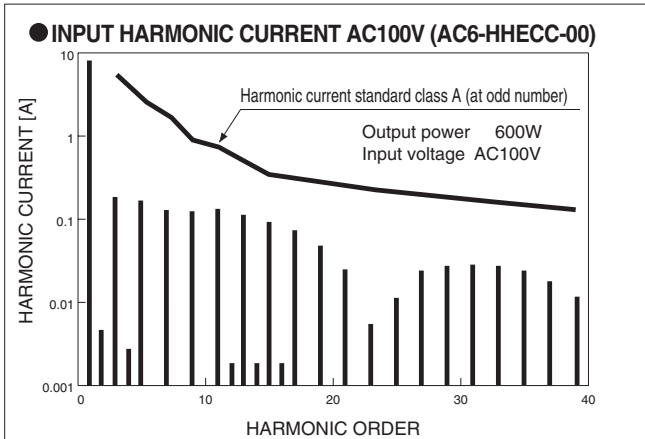
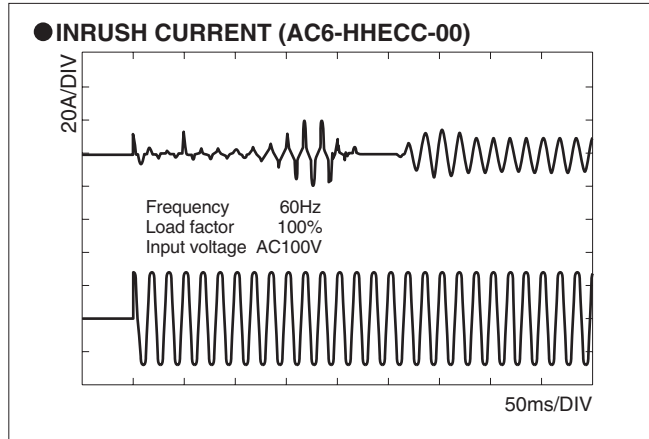
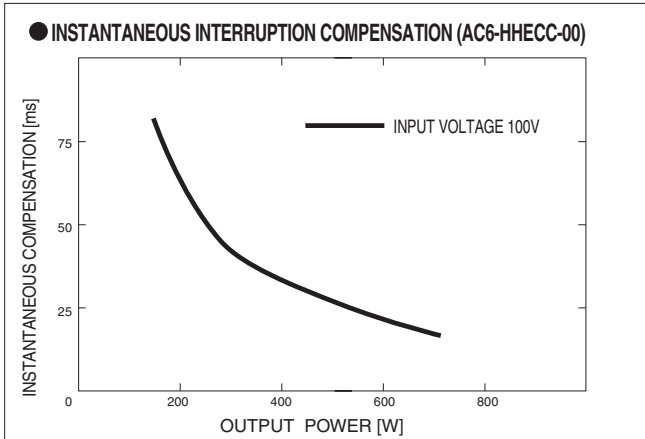
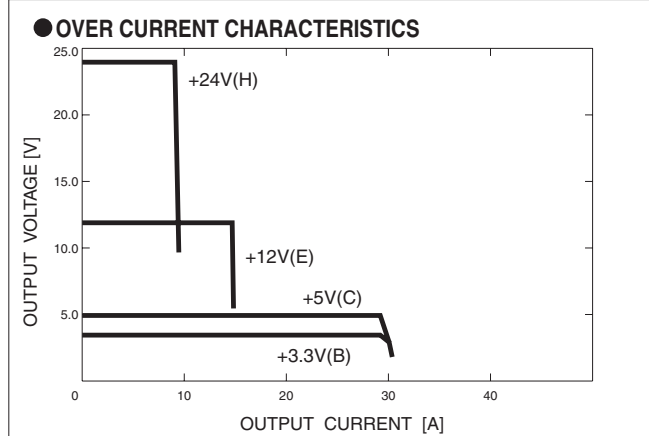
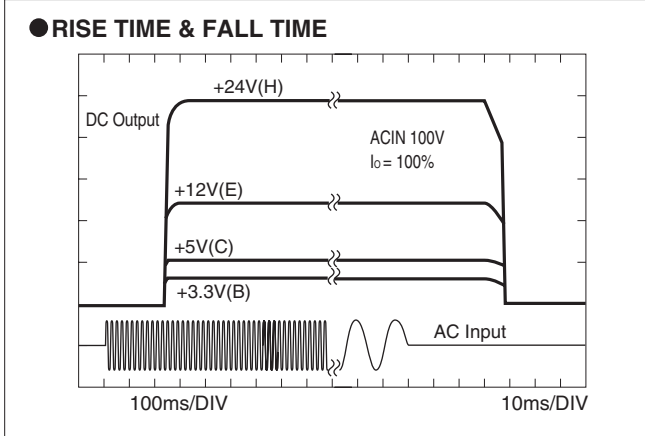

● RISE TIME & FALL TIME

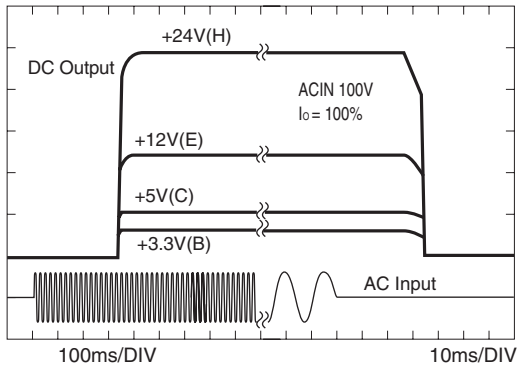

● OVER CURRENT CHARACTERISTICS

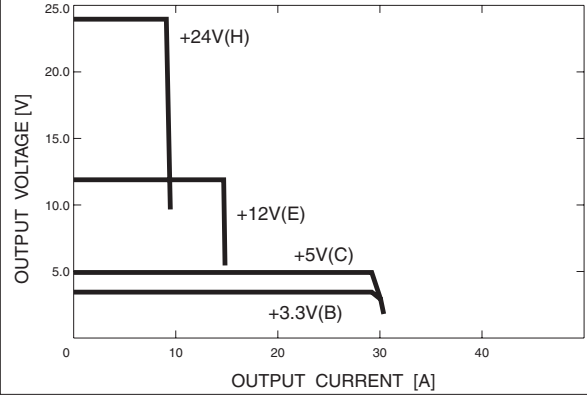

● INSTANTANEOUS INTERRUPTION COMPENSATION (AC9-HHEECC-00)

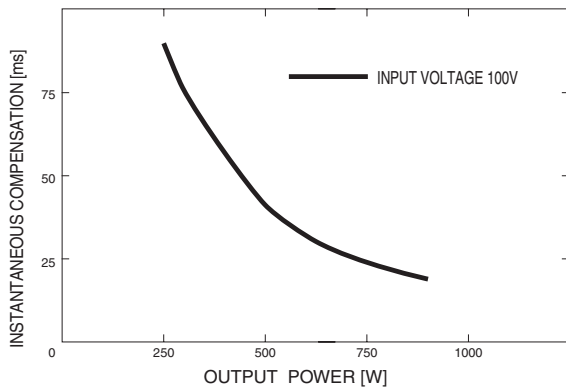

● INRUSH CURRENT (AC9-HHEECC-00)

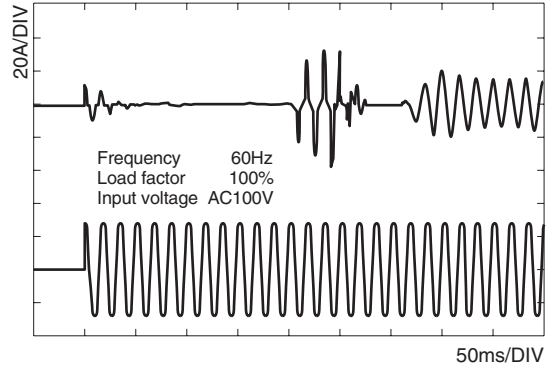

● INPUT HARMONIC CURRENT AC100V (AC9-HHEECC-00)

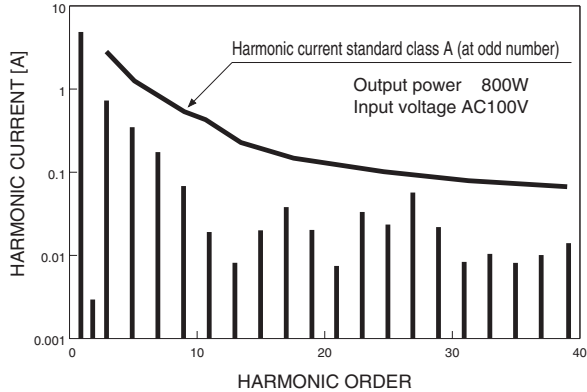

● INPUT HARMONIC CURRENT AC230V (AC9-HHEECC-00)

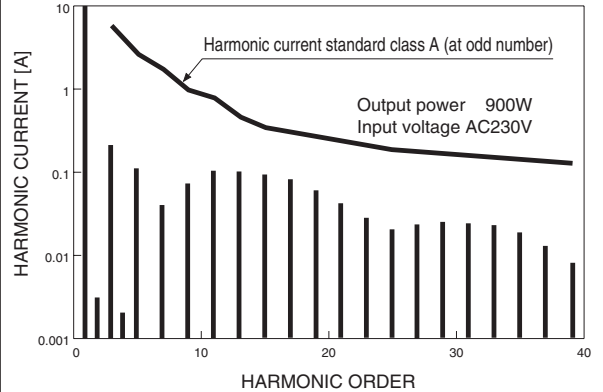

● POWER FACTOR & INPUT CURRENT (AC9-HHEECC-00)

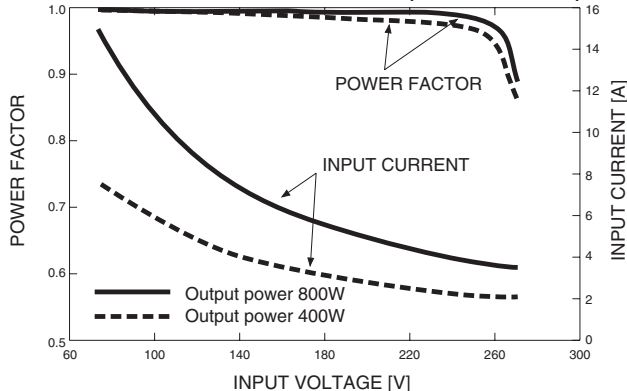

● EFFICIENCY (AC9-HHEECC-00)

