

Small Signal Zener Diodes

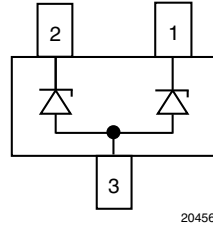

20456

LINKS TO ADDITIONAL RESOURCES



MARKING (example only)

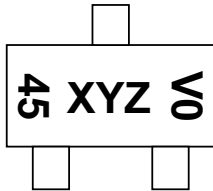

XYZ = type code
 45 = working week
 0 = year
 V = Vishay

FEATURES

- Silicon planar Zener diodes
- The Zener voltages are graded according to the international E24 standard. Standard Zener voltage tolerance is $\pm 5\%$, indicated by the "C" in the ordering code. Replace "C" with "B" for $\pm 2\%$ tolerance.
- AEC-Q101 qualified available (part number on request)
- ESD capability acc. to AEC-Q101:
human body model: $> 8\text{ kV}$,
machine model: $> 800\text{ V}$
- Base P/N-G3 - green, commercial grade
- Material categorization: for definitions of compliance please see www.vishay.com/doc?99912



PRIMARY CHARACTERISTICS

PARAMETER	VALUE	UNIT
V_Z range nom.	2.2 to 75	V
Test current I_{ZT}	2; 5	mA
V_Z specification	Pulse current	
Circuit configuration	Common anode	

ORDERING INFORMATION

DEVICE NAME	ORDERING CODE	ZENER VOLTAGE TOLERANCE	AEC-Q101 QUALIFIED	TAPED UNITS PER REEL	MINIMUM ORDER QUANTITY
AZ23-G series	AZ23C2V4-G3-08 to AZ23C75-G3-08	5 %	no	3000 (8 mm tape on 7" reel)	15 000
	AZ23B2V4-G3-08 to AZ23B75-G3-08	2 %	no		
	AZ23C2V4-G3-18 to AZ23C75-G3-18	5 %	no	10 000 (8 mm tape on 13" reel)	10 000
	AZ23B2V4-G3-18 to AZ23B75-G3-18	2 %	no		

PACKAGE

PACKAGE NAME	WEIGHT	MOLDING COMPOUND FLAMMABILITY RATING	MOISTURE SENSITIVITY LEVEL	SOLDERING CONDITIONS
SOT-23	9.2 mg	UL 94 V-0	MSL level 1 (according J-STD-020)	Peak temperature max. 260 °C

ABSOLUTE MAXIMUM RATINGS

PARAMETER	TEST CONDITION	SYMBOL	VALUE	UNIT
Power dissipation	$R_{thJL} = 250\text{ K/W}$	P_{tot}	500	mW
	On FR-4 board with recommended soldering footprint	P_{tot}	300	mW
Thermal resistance junction to lead		R_{thJL}	250	K/W
Thermal resistance junction to ambient	According to JEDEC® 51-3 on FR-4 board with recommended soldering footprint	R_{thJA}	420	K/W
Junction temperature		T_j	150	°C
Storage temperature range		T_{stg}	-65 to +150	°C
Operating temperature range		T_{op}	-55 to +150	°C



ELECTRICAL CHARACTERISTICS ($T_{amb} = 25\text{ }^{\circ}\text{C}$, unless otherwise specified)												
PART NUMBER	MARKING CODE	ZENER VOLTAGE RANGE ⁽¹⁾			TEST CURRENT		REVERSE LEAKAGE CURRENT		DYNAMIC RESISTANCE $f = 1\text{ kHz}$		TEMPERATURE COEFFICIENT	
		V_Z at I_{ZT1}			I_{ZT1}	I_{ZT2}	I_R at V_R		Z_Z at I_{ZT1}	Z_{ZK} at I_{ZT2}	α_{VZ} at I_{ZT1}	
		V			mA		μA	V	Ω		$10^{-4}/^{\circ}\text{C}$	
		MIN.	NOM.	MAX.			MAX.		MAX.	MAX.	MIN.	MAX.
AZ23C2V2-G	D77	2.09	2.2	2.31	5	1	100	1	120	600	-9	-4
AZ23C2V4-G	D78	2.28	2.4	2.52	5	1	50	1	100	600	-9	-4
AZ23C2V7-G	D41	2.57	2.7	2.84	5	1	20	1	83	500	-9	-4
AZ23C3V0-G	D42	2.85	3.0	3.15	5	1	10	1	95	500	-9	-3
AZ23C3V3-G	D43	3.14	3.3	3.47	5	1	5	1	95	500	-8	-3
AZ23C3V6-G	D44	3.42	3.6	3.78	5	1	5	1	90	500	-8	-3
AZ23C3V9-G	D45	3.71	3.9	4.10	5	1	3	1	90	500	-7	-3
AZ23C4V3-G	D46	4.09	4.3	4.52	5	1	3	1	90	500	-6	-1
AZ23C4V7-G	D47	4.47	4.7	4.94	5	1	3	2	78	500	-5	2
AZ23C5V1-G	D48	4.85	5.1	5.36	5	1	2	2	60	480	-3	4
							0.1	0.8				
AZ23C5V6-G	D49	5.32	5.6	5.88	5	1	1	2	40	400	-2	6
							0.1	1				
AZ23C6V2-G	D50	5.89	6.2	6.51	5	1	3	4	10	150	-1	7
							0.1	2				
AZ23C6V8-G	D51	6.46	6.8	7.14	5	1	2	4	8	80	2	7
							0.1	3				
AZ23C7V5-G	D52	7.13	7.5	7.88	5	1	0.1	5	7	50	3	7
AZ23C8V2-G	D53	7.79	8.2	8.61	5	1	0.1	6	7	50	4	7
AZ23C9V1-G	D54	8.65	9.1	9.56	5	1	0.1	7	10	50	5	8
AZ23C10-G	D55	9.50	10	10.50	5	1	0.1	7.5	15	70	5	8
AZ23C11-G	D56	10.45	11	11.55	5	1	0.1	8.5	20	70	5	9
AZ23C12-G	D57	11.40	12	12.60	5	1	0.1	9	20	90	6	9
AZ23C13-G	D58	12.40	13	13.65	5	1	0.1	10	25	110	7	9
AZ23C15-G	D59	14.25	15	15.60	5	1	0.05	11	30	110	7	9
AZ23C16-G	D60	15.30	16	16.80	5	1	0.05	12	40	170	8	9.5
AZ23C18-G	D61	17.10	18	18.90	5	1	0.05	14	45	170	8	9.5
AZ23C20-G	D62	19.00	20	21.00	5	1	0.05	15	50	220	8	10
AZ23C22-G	D63	20.90	22	23.10	5	1	0.05	17	55	220	8	10
AZ23C24-G	D64	22.80	24	25.20	5	1	0.05	18	70	220	8	10
AZ23C27-G	D65	25.65	27	28.35	2	0.5	0.05	20	80	250	8	10
AZ23C30-G	D66	28.50	30	31.50	2	0.5	0.05	22.5	80	250	8	10
AZ23C33-G	D67	31.35	33	34.65	2	0.5	0.05	25	80	250	8	10
AZ23C36-G	D68	34.20	36	37.80	2	0.5	0.05	27	87	250	8	10
AZ23C39-G	D69	37.05	39	40.95	2	0.5	0.05	29	87	300	10	12
AZ23C43-G	D70	40.85	43	45.15	2	0.5	0.05	32	97	375	10	12
AZ23C47-G	D71	44.65	47	49.35	2	0.5	0.05	35	97	375	10	12
AZ23C51-G	D72	48.45	51	53.55	2	0.5	0.05	38	100	400	10	12
AZ23C56-G	D73	53.20	56	58.80	2	0.5	0.05	42	135	425	9	11
AZ23C62-G	D74	58.90	62	65.10	2	0.5	0.05	46.5	150	450	9	12
AZ23C68-G	D75	64.60	68	71.40	2	0.5	0.05	51	200	475	10	12
AZ23C75-G	D76	71.25	75	78.75	2	0.5	0.05	56	250	500	10	12



ELECTRICAL CHARACTERISTICS (T _{amb} = 25 °C, unless otherwise specified)												
PART NUMBER	MARKING CODE	ZENER VOLTAGE RANGE ⁽¹⁾			TEST CURRENT		REVERSE LEAKAGE CURRENT		DYNAMIC RESISTANCE f = 1 kHz		TEMPERATURE COEFFICIENT	
		V _Z at I _{ZT1}			I _{ZT1}	I _{ZT2}	I _R at V _R		Z _Z at I _{ZT1}	Z _{ZK} at I _{ZT2}	α _{VZ} at I _{ZT1}	
		V			mA		μA	V	Ω		10 ⁻⁴ /°C	
		MIN.	NOM.	MAX.			MAX.		MAX.	MAX.	MIN.	MAX.
AZ23B2V2-G	DG8	2.16	2.2	2.24	5	1	100	1	120	600	-9	-4
AZ23B2V4-G	DG9	2.35	2.4	2.45	5	1	50	1	100	600	-9	-4
AZ23B2V7-G	DD1	2.65	2.7	2.75	5	1	20	1	83	500	-9	-4
AZ23B3V0-G	DD2	2.94	3.0	3.06	5	1	10	1	95	500	-9	-3
AZ23B3V3-G	DD3	3.23	3.3	3.37	5	1	5	1	95	500	-8	-3
AZ23B3V6-G	DD4	3.53	3.6	3.67	5	1	5	1	90	500	-8	-3
AZ23B3V9-G	DD5	3.82	3.9	3.98	5	1	3	1	90	500	-7	-3
AZ23B4V3-G	DD6	4.21	4.3	4.39	5	1	3	1	90	500	-6	-1
AZ23B4V7-G	DD7	4.61	4.7	4.79	5	1	3	2	78	500	-5	2
AZ23B5V1-G	DD8	5.00	5.1	5.20	5	1	2	2	60	480	-3	4
AZ23B5V6-G	DD9	5.49	5.6	5.71	5	1	0.1	0.8	40	400	-2	6
AZ23B6V2-G	DE0	6.08	6.2	6.32	5	1	1	2	10	150	-1	7
AZ23B6V8-G	DE1	6.66	6.8	6.94	5	1	0.1	1	8	80	2	7
AZ23B7V5-G	DE2	7.35	7.5	7.65	5	1	2	4	7	50	3	7
AZ23B8V2-G	DE3	8.04	8.2	8.36	5	1	0.1	3	7	50	4	7
AZ23B9V1-G	DE4	8.92	9.1	9.28	5	1	0.1	4	10	50	5	8
AZ23B10-G	DE5	9.80	10	10.20	5	1	0.1	7	15	70	5	8
AZ23B11-G	DE6	10.78	11	11.22	5	1	0.1	7.5	20	70	5	9
AZ23B12-G	DE7	11.76	12	12.24	5	1	0.1	8.5	20	90	6	9
AZ23B13-G	DE8	12.74	13	13.26	5	1	0.1	9	25	110	7	9
AZ23B15-G	DE9	14.70	15	15.30	5	1	0.1	10	30	110	7	9
AZ23B16-G	DF0	15.68	16	16.32	5	1	0.05	11	40	170	8	9.5
AZ23B18-G	DF1	17.64	18	18.36	5	1	0.05	12	45	170	8	9.5
AZ23B20-G	DF2	19.60	20	20.40	5	1	0.05	14	50	220	8	10
AZ23B22-G	DF3	21.56	22	22.44	5	1	0.05	15	55	220	8	10
AZ23B24-G	DF4	23.52	24	24.48	5	1	0.05	17	70	220	8	10
AZ23B27-G	DF5	26.46	27	27.54	2	0.5	0.05	18	80	250	8	10
AZ23B30-G	DF6	29.40	30	30.60	2	0.5	0.05	20	80	250	8	10
AZ23B33-G	DF7	32.34	33	33.66	2	0.5	0.05	22.5	80	250	8	10
AZ23B36-G	DF8	35.28	36	36.72	2	0.5	0.05	25	80	250	8	10
AZ23B39-G	DF9	38.22	39	39.78	2	0.5	0.05	27	87	250	8	10
AZ23B43-G	DG0	42.14	43	43.86	2	0.5	0.05	29	87	300	10	12
AZ23B47-G	DG1	46.06	47	47.94	2	0.5	0.05	32	97	375	10	12
AZ23B51-G	DG2	49.98	51	52.02	2	0.5	0.05	35	97	375	10	12
AZ23B56-G	DG3	54.88	56	57.12	2	0.5	0.05	38	100	400	10	12
AZ23B62-G	DG5	60.76	62	63.24	2	0.5	0.05	42	135	425	9	11
AZ23B68-G	DG6	66.64	68	69.36	2	0.5	0.05	46.5	150	450	9	12
AZ23B75-G	DG7	73.50	75	76.50	2	0.5	0.05	51	200	475	10	12
AZ23B75-G	DG7	73.50	75	76.50	2	0.5	0.05	56	250	500	10	12

TYPICAL CHARACTERISTICS ($T_{amb} = 25\text{ }^{\circ}\text{C}$, unless otherwise specified)

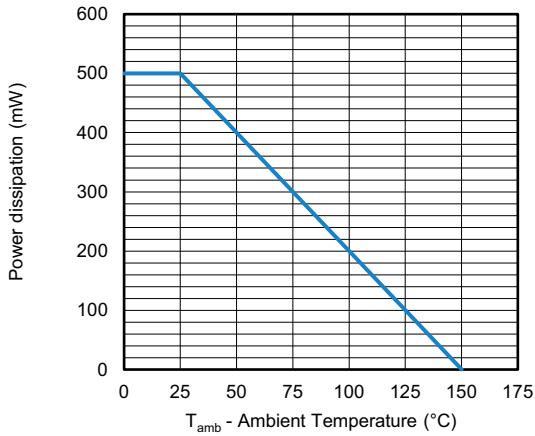

Fig. 1 - Admissible Power Dissipation vs. Ambient Temperature

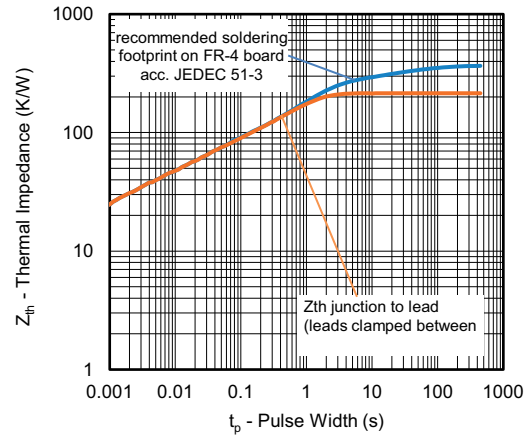
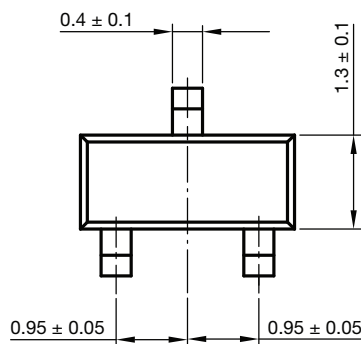
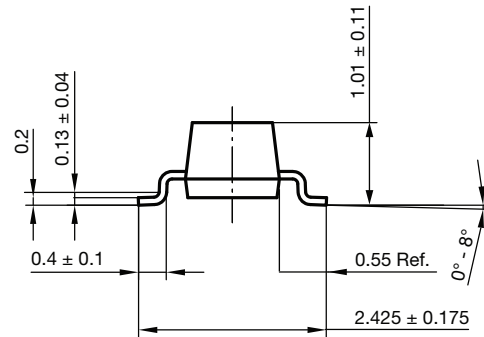
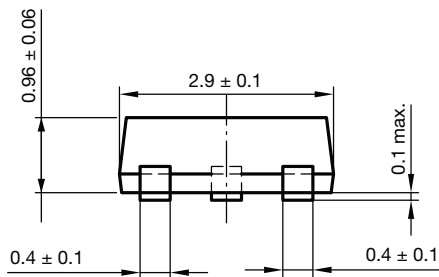
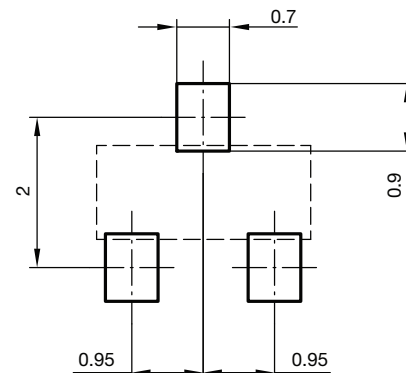

Fig. 2 - Thermal Impedance vs. Time

PACKAGE DIMENSIONS in millimeters (inches): **SOT-23**



Foot print recommendation:



Document no.: S8-V-3929.01-009 (4)
Created - Date: 18. Oct. 2021
Rev. 01 - Date: 18. Jan. 2022



ORIENTATION IN CARRIER TAPE



S8-V-3929.01-006 (4)
 Created Date: 04.02.2010
 Rev. 02 Date: 07.11.2022

CARRIER TAPE



B-B Section

Document no.: S8-V-3929.01-005 (4)
 Created - Date: 04. Feb. 2010



Disclaimer

ALL PRODUCT, PRODUCT SPECIFICATIONS AND DATA ARE SUBJECT TO CHANGE WITHOUT NOTICE TO IMPROVE RELIABILITY, FUNCTION OR DESIGN OR OTHERWISE.

Vishay Intertechnology, Inc., its affiliates, agents, and employees, and all persons acting on its or their behalf (collectively, "Vishay"), disclaim any and all liability for any errors, inaccuracies or incompleteness contained in any datasheet or in any other disclosure relating to any product.

Vishay makes no warranty, representation or guarantee regarding the suitability of the products for any particular purpose or the continuing production of any product. To the maximum extent permitted by applicable law, Vishay disclaims (i) any and all liability arising out of the application or use of any product, (ii) any and all liability, including without limitation special, consequential or incidental damages, and (iii) any and all implied warranties, including warranties of fitness for particular purpose, non-infringement and merchantability.

Statements regarding the suitability of products for certain types of applications are based on Vishay's knowledge of typical requirements that are often placed on Vishay products in generic applications. Such statements are not binding statements about the suitability of products for a particular application. It is the customer's responsibility to validate that a particular product with the properties described in the product specification is suitable for use in a particular application. Parameters provided in datasheets and / or specifications may vary in different applications and performance may vary over time. All operating parameters, including typical parameters, must be validated for each customer application by the customer's technical experts. Product specifications do not expand or otherwise modify Vishay's terms and conditions of purchase, including but not limited to the warranty expressed therein.

Hyperlinks included in this datasheet may direct users to third-party websites. These links are provided as a convenience and for informational purposes only. Inclusion of these hyperlinks does not constitute an endorsement or an approval by Vishay of any of the products, services or opinions of the corporation, organization or individual associated with the third-party website. Vishay disclaims any and all liability and bears no responsibility for the accuracy, legality or content of the third-party website or for that of subsequent links.

Vishay products are not designed for use in life-saving or life-sustaining applications or any application in which the failure of the Vishay product could result in personal injury or death unless specifically qualified in writing by Vishay. Customers using or selling Vishay products not expressly indicated for use in such applications do so at their own risk. Please contact authorized Vishay personnel to obtain written terms and conditions regarding products designed for such applications.

No license, express or implied, by estoppel or otherwise, to any intellectual property rights is granted by this document or by any conduct of Vishay. Product names and markings noted herein may be trademarks of their respective owners.