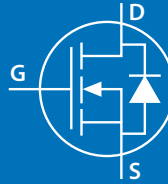

EPC2306 – Enhancement Mode Power Transistor

 V_{DS} , 100 V $R_{DS(on)}$, 3.1 mΩ max

Revised December 19, 2024

Gallium Nitride's exceptionally high electron mobility and low temperature coefficient allows very low $R_{DS(on)}$ while its lateral device structure and majority carrier diode provide exceptionally low Q_G and zero Q_{RR} . The end result is a device that can handle tasks where very high switching frequency, and low on-time are beneficial as well as those where on-state losses dominate.

Application Notes:

- Easy-to-use and reliable gate, Gate Drive ON = 5 V typical, OFF = 0 V (negative voltage not needed)
- Top of FET is electrically connected to source

Questions:
Ask a GaN
Expert

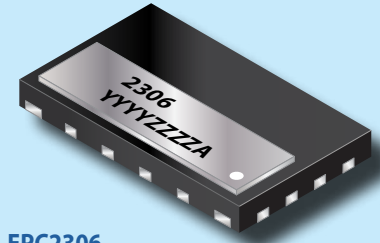
**EPC2306**

Package size: 3 x 5 mm

Maximum Ratings			
PARAMETER		VALUE	UNIT
V_{DS}	Drain-to-Source Voltage (Continuous)	100	V
	Drain-to-Source Voltage (Repetitive Transient) ⁽¹⁾	120	
I_D	Continuous ($T_J \leq 125^\circ\text{C}$) ⁽²⁾	62	A
	Pulsed (25°C , $T_{PULSE} = 300 \mu\text{s}$)	197	
V_{GS}	Gate-to-Source Voltage	6	V
	Gate-to-Source Voltage	-4	
T_J	Operating Temperature	-40 to 150	$^\circ\text{C}$
T_{STG}	Storage Temperature	-55 to 175	

⁽¹⁾ Pulsed repetitively, duty cycle factor (DCFactor) $\leq 1\%$; See Figure 13 and Reliability Report Phase 16, Section 3.2.6"

⁽²⁾ Electromigration current limit; See Reliability Report Phase 16, Section 3.3.4

Thermal Characteristics			
PARAMETER		TYP	UNIT
$R_{\theta JC}$	Thermal Resistance, Junction-to-Case (Case TOP)	0.5	$^\circ\text{C}/\text{W}$
$R_{\theta JB}$	Thermal Resistance, Junction-to-Board (Case BOTTOM)	3.0	
$R_{\theta JA_JEDEC}$	Thermal Resistance, Junction-to-Ambient (using JEDEC 51-2 PCB)	54	
$R_{\theta JA_EVB}$	Thermal Resistance, Junction-to-Ambient (using EPC90145 EVB)	23	

Static Characteristics ($T_J = 25^\circ\text{C}$ unless otherwise stated)						
PARAMETER		TEST CONDITIONS	MIN	TYP	MAX	UNIT
BV_{DSS}	Drain-to-Source Voltage	$V_{GS} = 0 \text{ V}$, $I_D = 0.2 \text{ mA}$	100			V
I_{DSS}	Drain-Source Leakage	$V_{GS} = 0 \text{ V}$, $V_{DS} = 80 \text{ V}$		0.005	0.1	mA
I_{GSS}	Gate-to-Source Forward Leakage	$V_{GS} = 5 \text{ V}$		0.005	1.9	
	Gate-to-Source Forward Leakage [#]	$V_{GS} = 5 \text{ V}$, $T_J = 125^\circ\text{C}$		0.2	4.2	
	Gate-to-Source Reverse Leakage	$V_{GS} = -4 \text{ V}$		0.02	0.5	
$V_{GS(TH)}$	Gate Threshold Voltage	$V_{DS} = V_{GS}$, $I_D = 7 \text{ mA}$	0.8	1.3	2.5	V
$R_{DS(on)}$	Drain-Source On Resistance	$V_{GS} = 5 \text{ V}$, $I_D = 25 \text{ A}$		2.5	3.1	mΩ
V_{SD}	Source-Drain Forward Voltage [#]	$I_S = 0.5 \text{ A}$, $V_{GS} = 0 \text{ V}$		1.6		V

[#] Defined by design. Not subject to production test.

Applications

- AC-DC chargers, SMPS, adaptors, power supplies
- High frequency DC-DC conversion up to 80 V input (buck, boost, buck-boost and LLC)
- 24 V–60 V motor drives
- High power density DC-DC modules from 40 V–60 V to 5 V–12 V
- Synchronous rectification
- Solar MPPT

Benefits

- Higher efficiency – Lower conduction and switching losses, zero reverse recovery losses
- Ultra small footprint – Higher power density

Scan QR code or click link below for more information including reliability reports, device models, demo boards!



<https://l.ead.me/EPC2306>

Dynamic Characteristics# (T _J = 25°C unless otherwise stated)						
PARAMETER		TEST CONDITIONS	MIN	TYP	MAX	UNIT
C _{ISS}	Input Capacitance	V _{DS} = 50 V, V _{GS} = 0 V		1777	2369	pF
C _{RSS}	Reverse Transfer Capacitance			5.8		
C _{OSS}	Output Capacitance			616	803	
C _{OSS(ER)}	Effective Output Capacitance, Energy Related (Note 1)	V _{DS} = 0 to 50 V, V _{GS} = 0 V		730		
C _{OSS(TR)}	Effective Output Capacitance, Time Related (Note 2)			882		
R _G	Gate Resistance			0.4		Ω
Q _G	Total Gate Charge	V _{DS} = 50 V, V _{GS} = 5 V, I _D = 25 A		12.3	16.2	nC
Q _{GS}	Gate to Source Charge	V _{DS} = 50 V, I _D = 25 A		4.3		
Q _{GD}	Gate-to-Drain Charge			1.1		
Q _{G(TH)}	Gate Charge at Threshold			3.1		
Q _{OSS}	Output Charge	V _{DS} = 50 V, V _{GS} = 0 V		44	57	
Q _{RR}	Source-Drain Recovery Charge			0		

Defined by design. Not subject to production test.

All measurements were done with substrate shorted to source.

Note 1: C_{OSS(ER)} is a fixed capacitance that gives the same stored energy as C_{OSS} while V_{DS} is rising from 0 to 50% BV_{DSS}.

Note 2: C_{OSS(TR)} is a fixed capacitance that gives the same charging time as C_{OSS} while V_{DS} is rising from 0 to 50% BV_{DSS}.

Figure 1: Typical Output Characteristics at 25°C

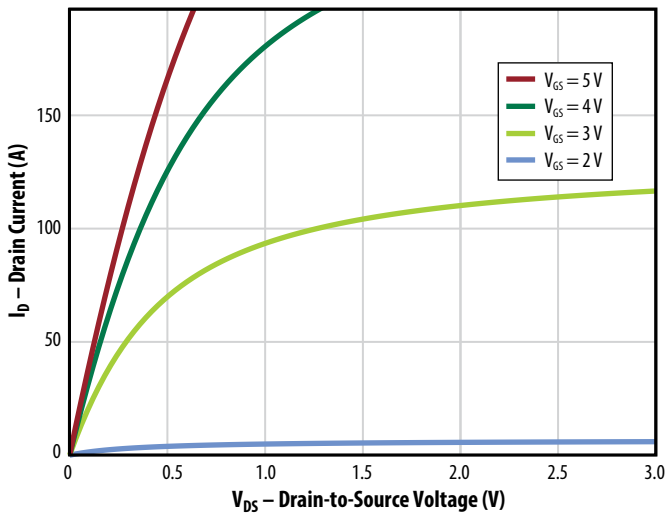

Figure 2: Typical Transfer Characteristics

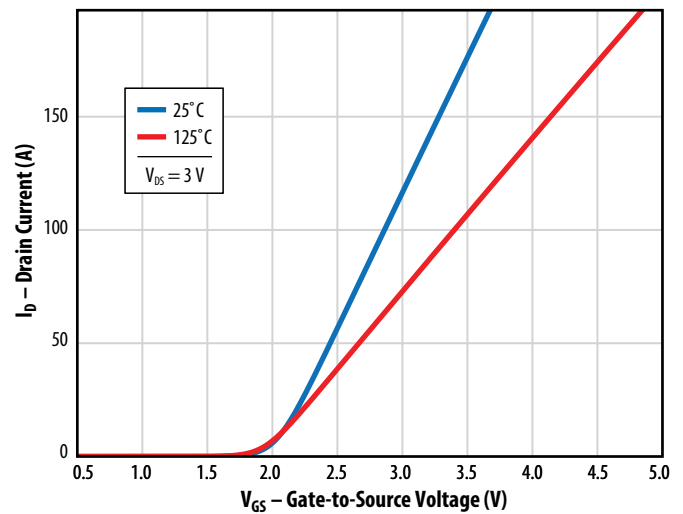

Figure 3: Typical R_{DS(on)} vs. V_{GS} for Various Drain Currents

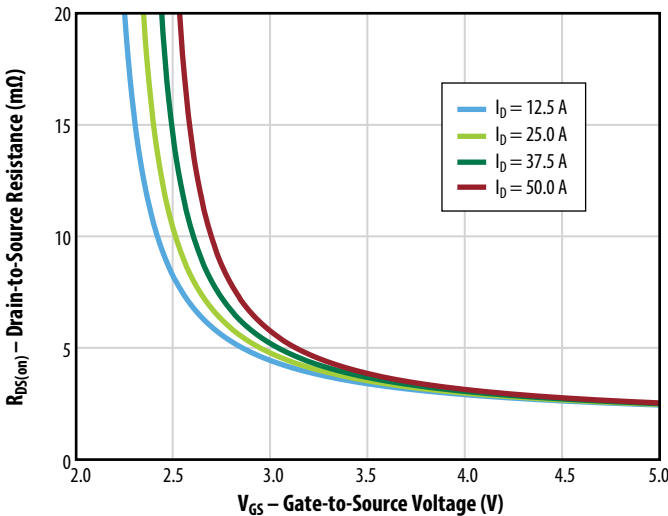

Figure 4: Typical R_{DS(on)} vs. V_{GS} for Various Temperatures

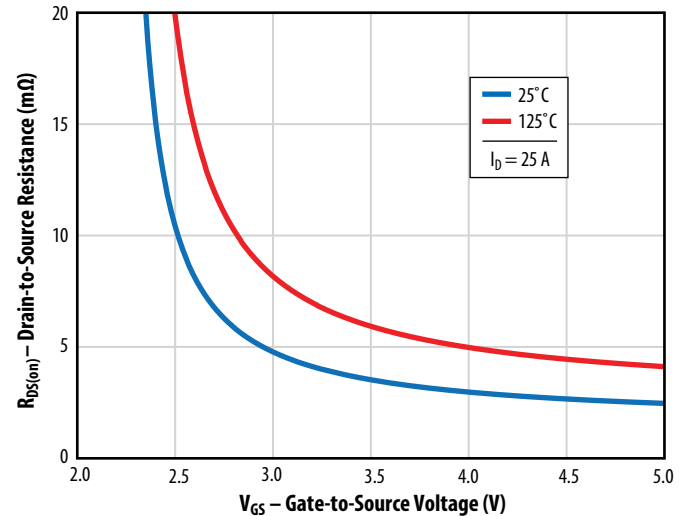

Figure 5a: Typical Capacitance (Linear Scale)

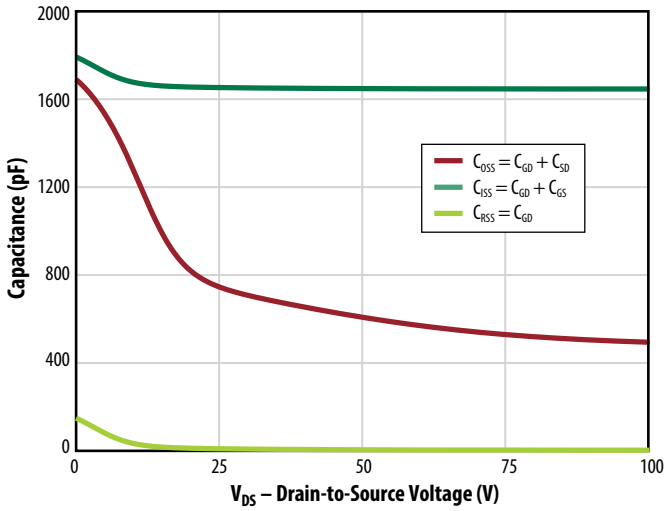

Figure 5b: Typical Capacitance (Log Scale)

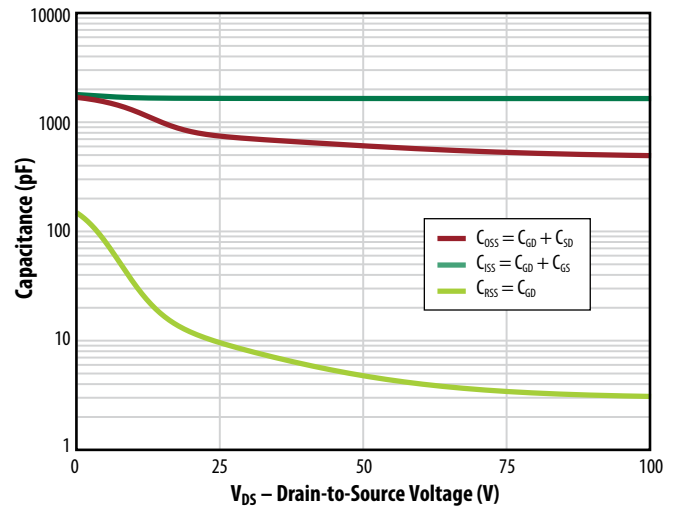

Figure 6: Typical Output Charge and C_oss Stored Energy

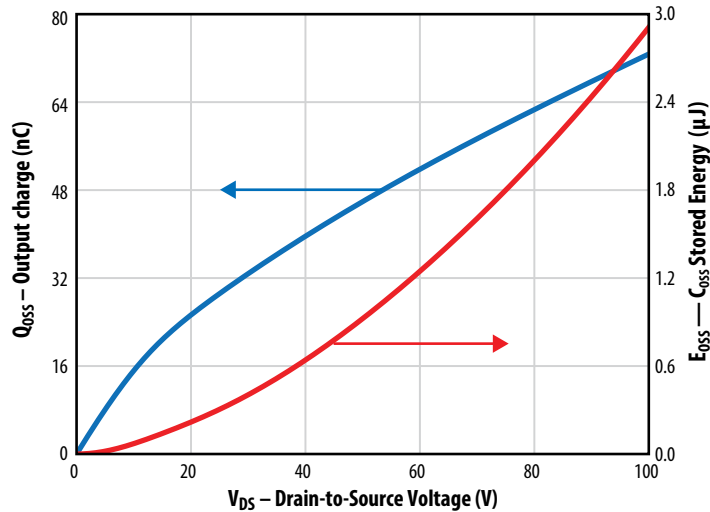

Figure 7: Typical Gate Charge

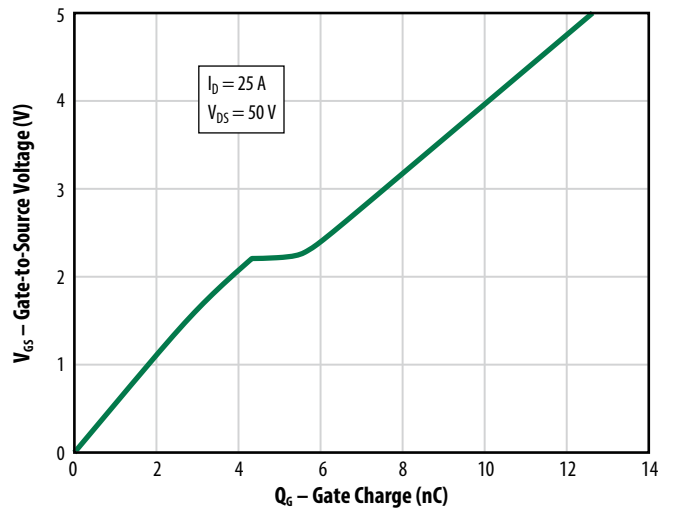
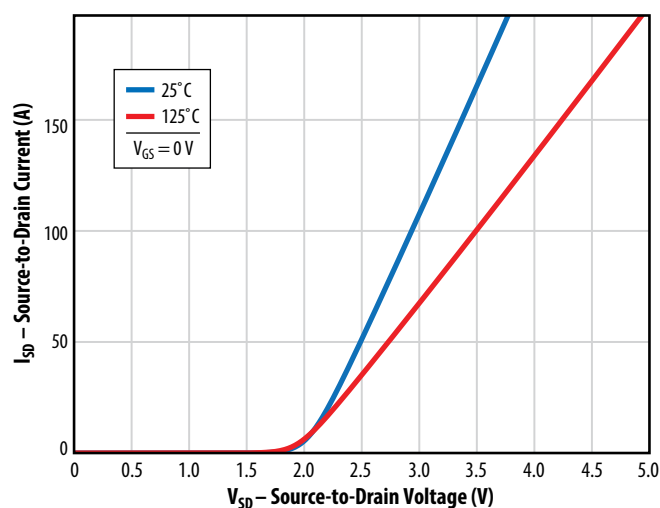

Figure 8: Typical Reverse Drain-Source Characteristics



Note: Negative gate drive voltage increases the reverse drain-source voltage. EPC recommends 0V for OFF.

Figure 9: Typical Normalized On-State Resistance vs. Temp.

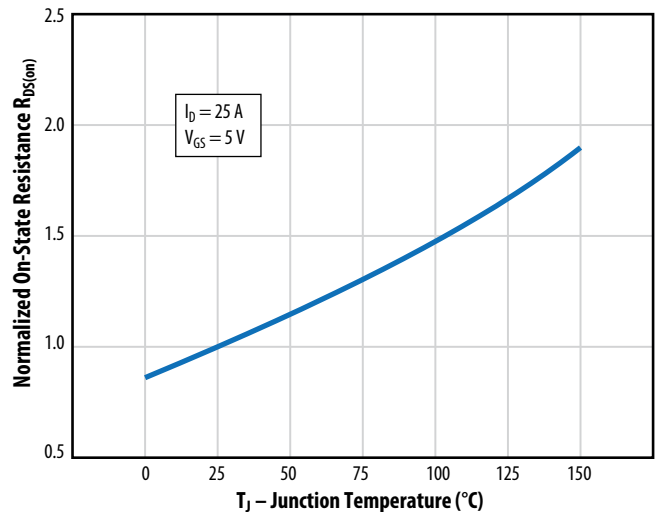

Figure 10: Typical Normalized Threshold Voltage vs. Temp.

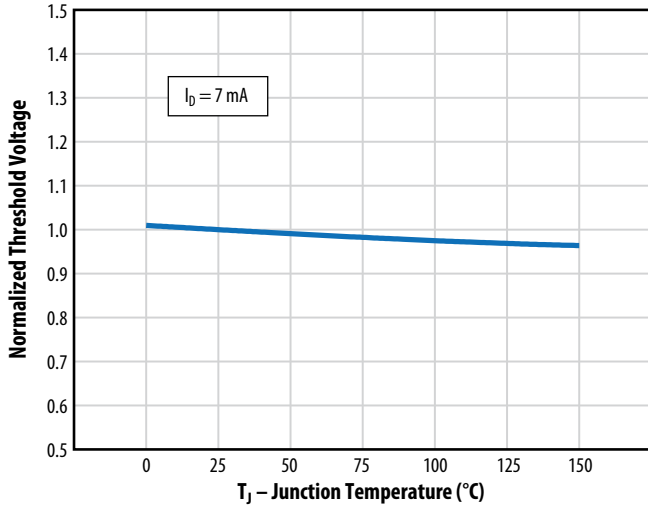

Figure 11: Safe Operating Area

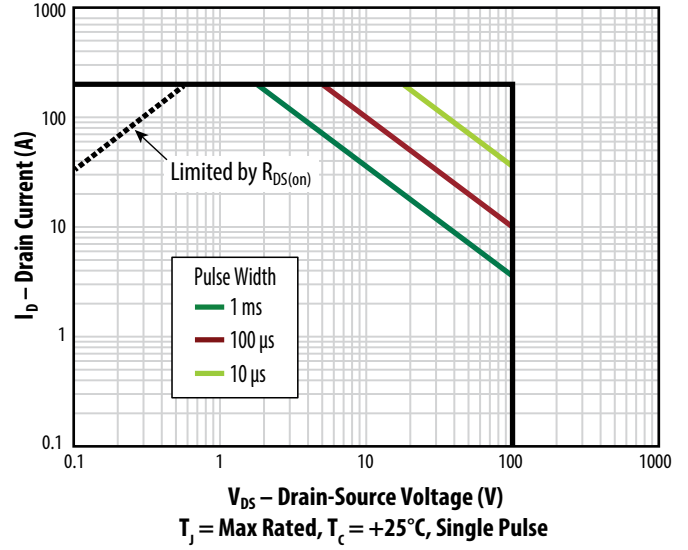

Figure 12: Typical Transient Thermal Response Curves

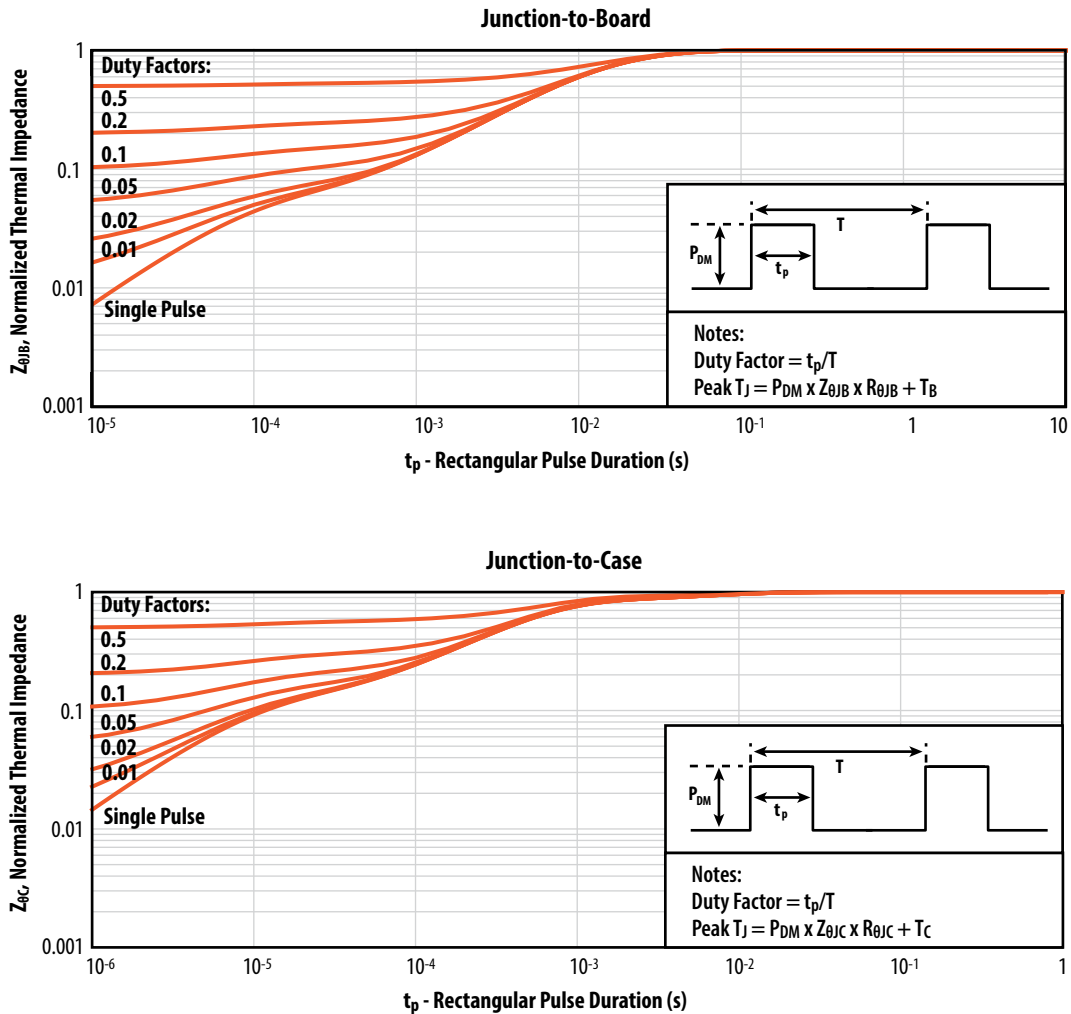
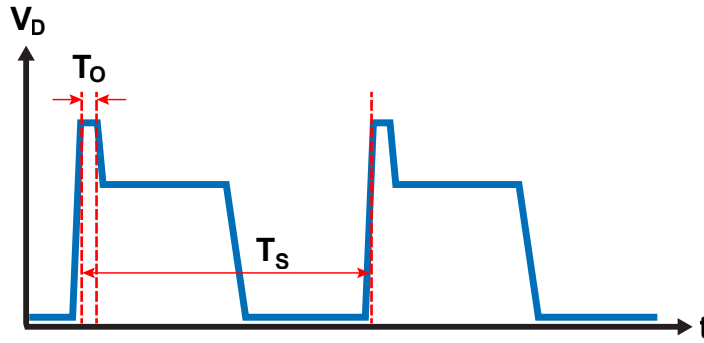

Figure 13: Duty Cycle Factor (DC_{Factor}) Illustration for Repetitive Overvoltage Specification



1% is the ratio between T_O (overvoltage duration) and T_S (one switching period).

LAYOUT CONSIDERATIONS

GaN transistors generally behave like power MOSFETs, but at much higher switching speeds and power densities, therefore layout considerations are very important, and care must be taken to minimize layout parasitic inductances. The recommended design utilizes the first inner layer as a power loop return path. This return path is located directly beneath the top layer’s power loop allowing for the smallest physical loop size. This method is also commonly referred to as flux cancellation. Variations of this concept can be implemented by placing the bus capacitors either next to the high side device, next to the low side device, or between the low and high side devices, but in all cases the loop is closed using the first inner layer right beneath the devices.

A similar concept is also used for the gate loop, with the return gate loop located directly under the turn ON and OFF gate resistors.

Furthermore, to minimize the common source inductance between power and gate loops, the power and gate loops are laid out perpendicular to each other, and a via next to the source pad closest to the gate pad is used as Kelvin connection for the gate driver return path.

The [EPC90145 Half-Bridge Development Board Using EPC2306](#) implements our recommended vertical inner layout.

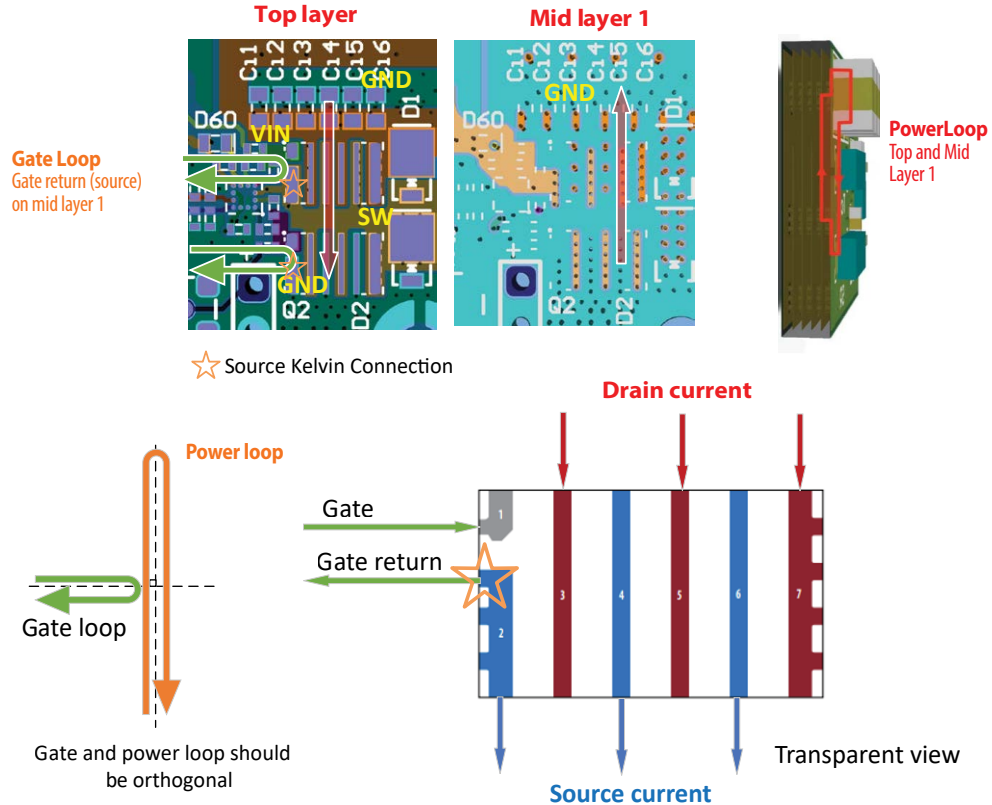

Figure 14: Inner Vertical Layout for Power and Gate Loops from EPC90145

Detailed recommendations on layout can be found on EPC’s website: [Optimizing PCB Layout with eGaN FETs.pdf](#)

TYPICAL SWITCHING BEHAVIOR

The following typical switching waveforms are captured in these conditions:

- **EPC90145: 100 V, 45 A Half-Bridge Development Board Featuring EPC2306**
- Gate driver: uP1966E with 0.4 Ω /0.7 Ω pull-down/pull-up resistance
- External $R_G(\text{ON}) = 1 \Omega$, $R_G(\text{OFF}) = 0 \Omega$
- $V_{\text{IN}} = 48 \text{ V}$, $I_L = 15 \text{ A}$

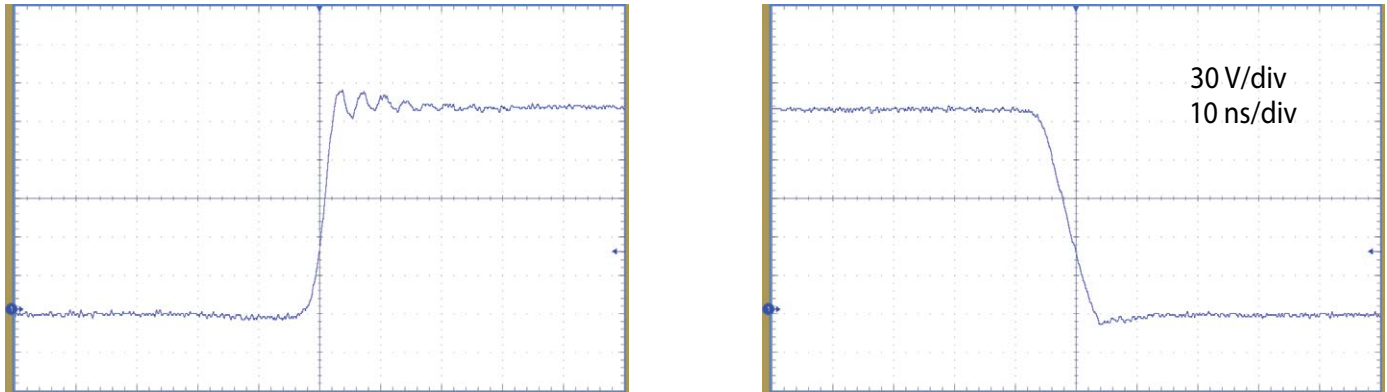

Figure 15: Typical half-bridge voltage switching waveforms

See the [EPC90145: 100 V, 45 A Half-Bridge Development Board Featuring EPC2306 Quick Start Guide](#) for more information.

TYPICAL THERMAL CONCEPT

The EPC2306 can take advantage of dual sided cooling to maximize its heat dissipation capabilities in high power density designs.

Note that the top of EPC FETs are connected to source potential, so for half-bridge topologies the Thermal Interface Material (TIM) needs to provide electrical isolation to the heatsink.

Recommended best practice thermal solutions are covered in detail in

[How2AppNote012 - How to Get More Power Out of an eGaN Converter.pdf](#).

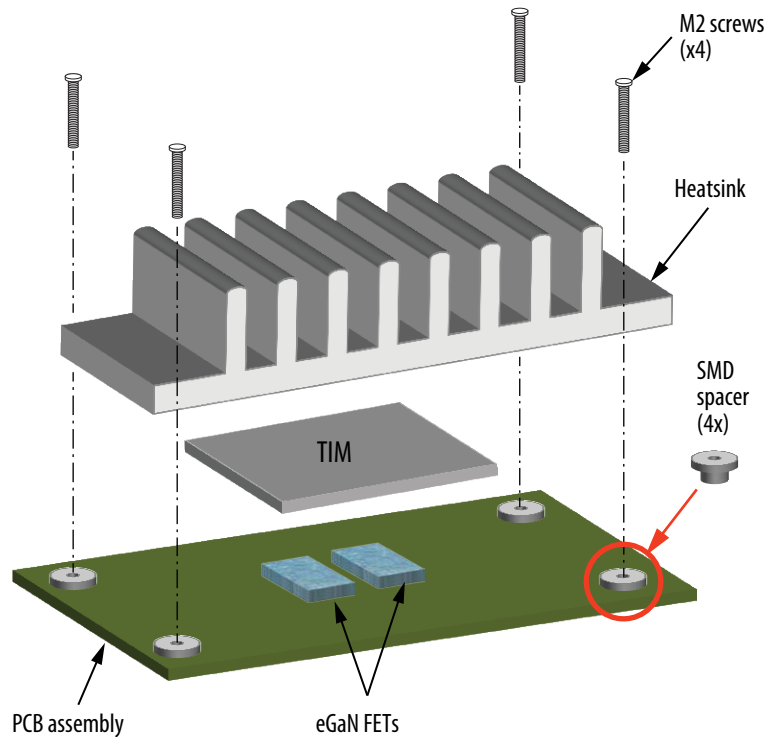

Figure 16: Exploded view of heatsink assembly using screws

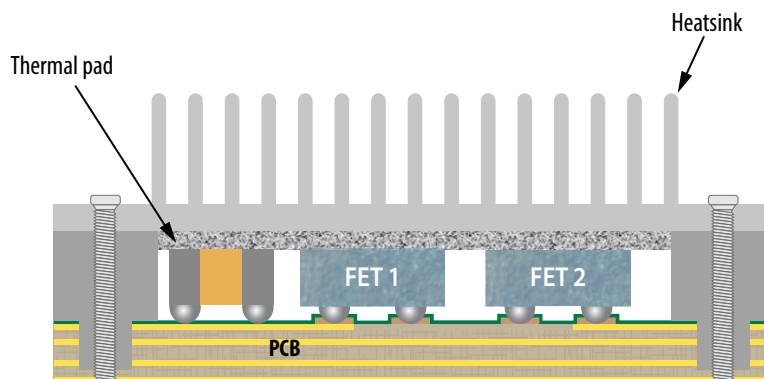
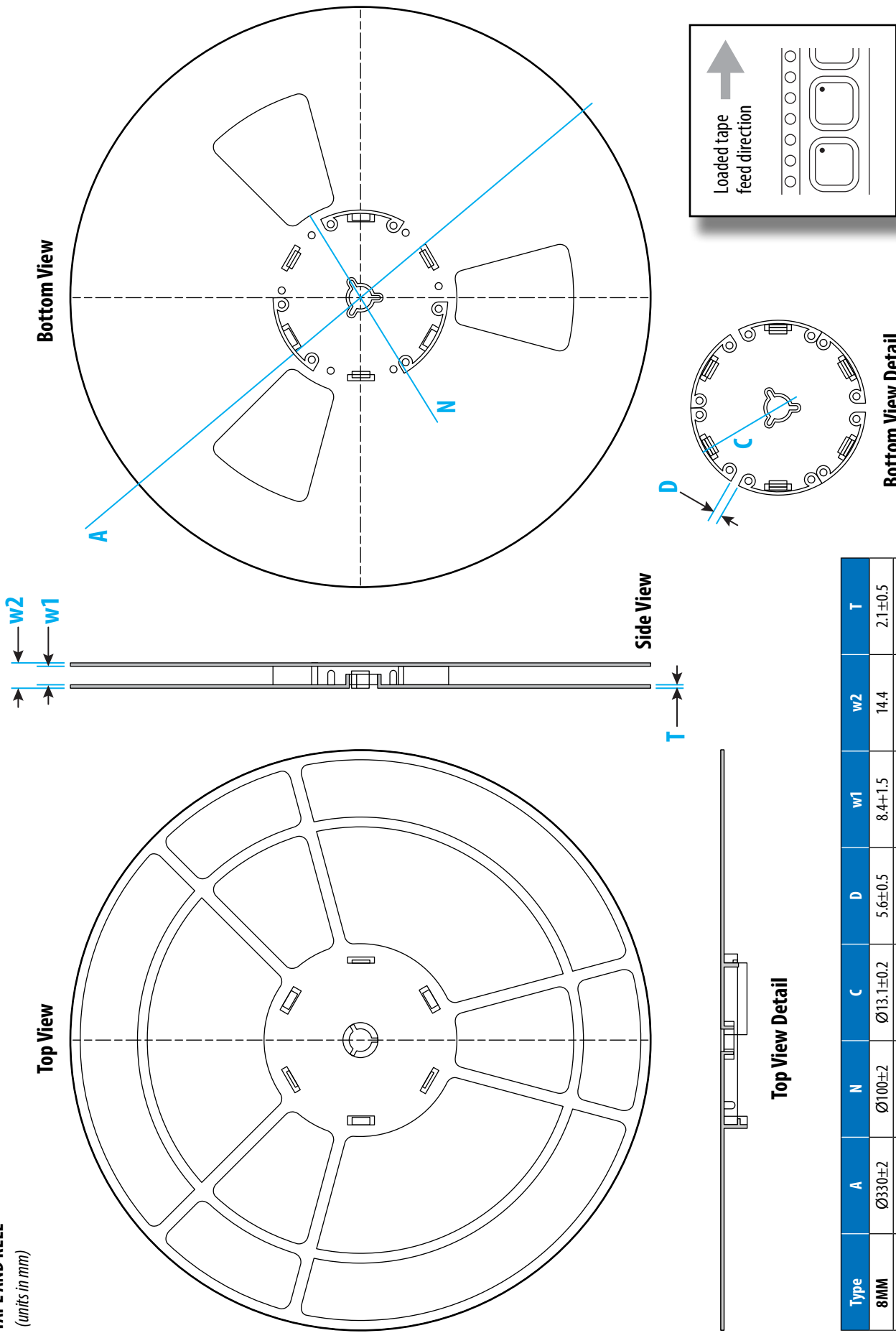

Figure 17: A cross-section image of dual sided thermal solution

Note: Connecting the heatsink to ground is recommended and can significantly improve radiated EMI

The thermal design can be optimized by using the [GaN FET Thermal Calculator](#) on EPC's website.

TAPE AND REEL
(units in mm)



Type	A	N	C	D	w1	w2	T
8MM	Ø330±2	Ø100±2	Ø13.1±0.2	5.6±0.5	8.4±1.5	14.4	2.1±0.5
12MM	Ø330±2	Ø100±2	Ø13.1±0.2	5.6±0.5	12.4±1.5	18.4	2.1±0.5
16MM	Ø330±2	Ø100±2	Ø13.1±0.2	5.6±0.5	16.4±1.5	22.4	2.1±0.5
24MM	Ø330±2	Ø100±2	Ø13.1±0.2	5.6±0.5	24.4±1.5	30.4	2.1±0.5

Part Marking

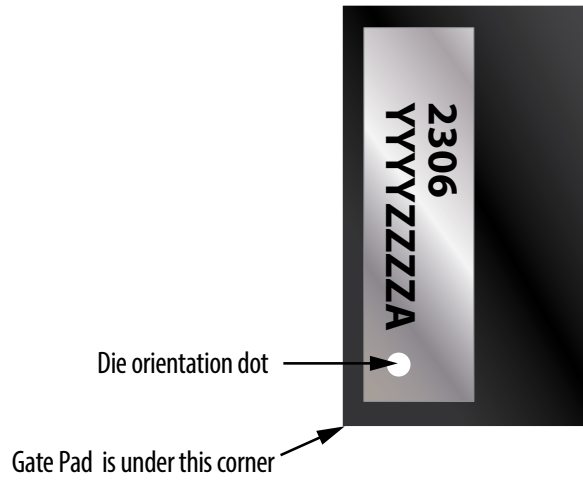

Part Number	Laser Markings	
	Part # Marking Line 1	Lot_Date Code Marking Line 2
EPC2306	2306	YYYYZZZZA

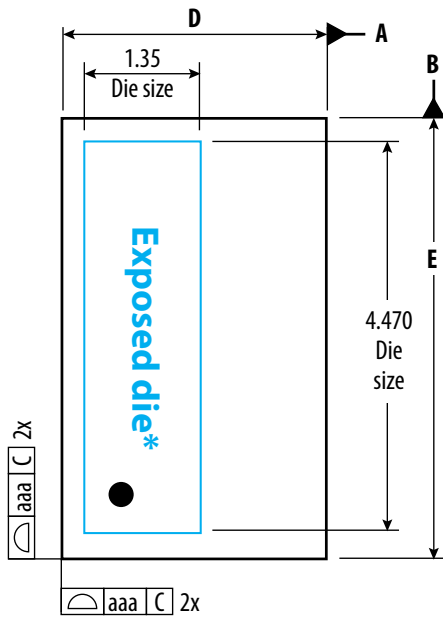
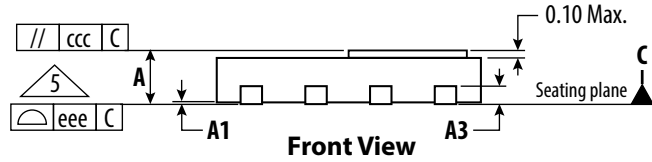
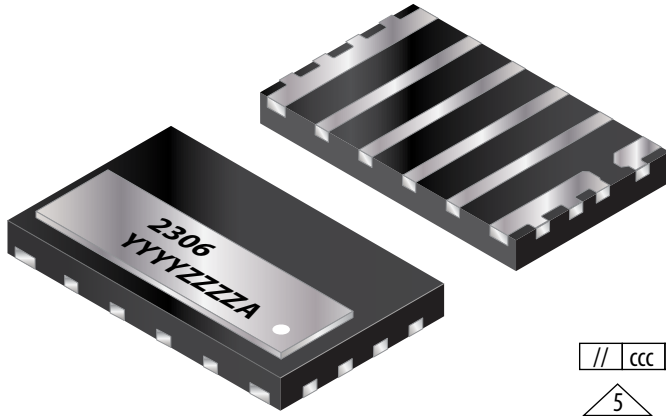

Top View

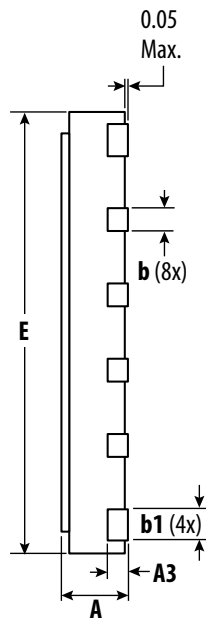

Side View

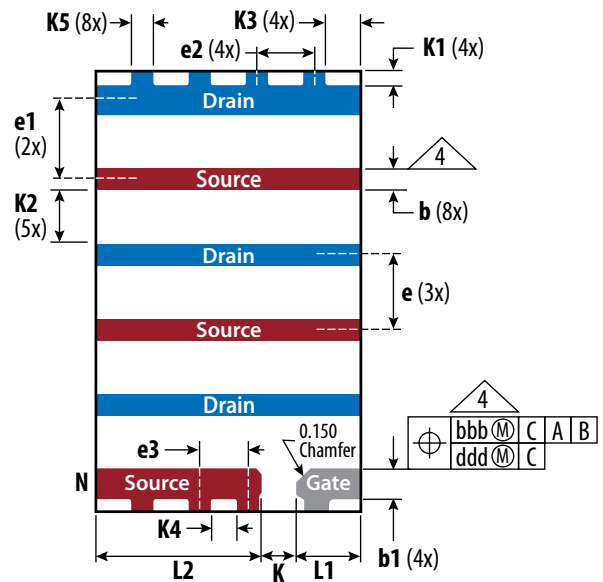

Bottom View

*The exposed die is the silicon substrate that is internally connected to the source. It is not recommended to use it as an electrical connection

SYMBOL	Dimension (mm)			Note
	MIN	Nominal	MAX	
A			0.70	
A1	0.00	0.02	0.05	
A3			0.25	
b	0.20	0.25	0.30	4
b1	0.30	0.35	0.40	4
D	2.90	3.00	3.10	
E	4.90	5.00	5.10	
e		0.85 BSC		
e1		0.90 BSC		
e2		0.65 BSC		
e3		0.55 BSC		
L1	0.625	0.725	0.825	
L2	1.775	1.875	1.975	

SYMBOL	Dimension (mm)			Note
	MIN	Nominal	MAX	
K		0.40 Ref		
K1		0.15 Ref		
K2		0.60 Ref		
K3		0.40 Ref		
K4		0.30 Ref		
K5		0.25 Ref		
aaa		0.05		
bbb		0.10		
ccc		0.10		
ddd		0.05		
eee		0.08		
N		7		3

Notes:

1. Dimensioning and tolerancing conform to ASME Y14.5-2009
2. All dimensions are in millimeters
3. N is the total number of terminals
4. Dimension b applies to the metallized terminal and a radius on the other end of it, dimension b should not be measured in that radius area.
5. Coplanarity applies to the terminals and all the other bottom surface metallization.

TRANSPARENT VIEW

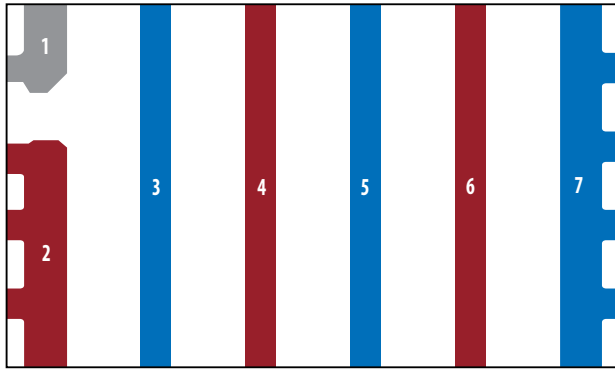

PIN	Description
1	Gate
2	Source
3	Drain
4	Source
5	Drain
6	Source
7	Drain

RECOMMENDED LAND PATTERN

(units in mm)

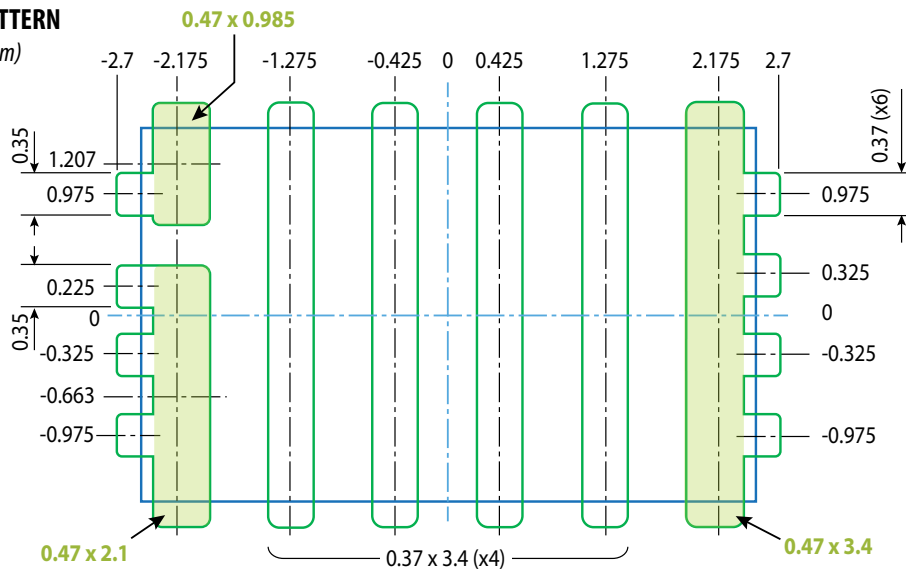

Land pattern is solder mask defined.

Legend:

Part outline
Mask opening

Radius = 0.05

RECOMMENDED STENCIL DRAWING

(units in mm)

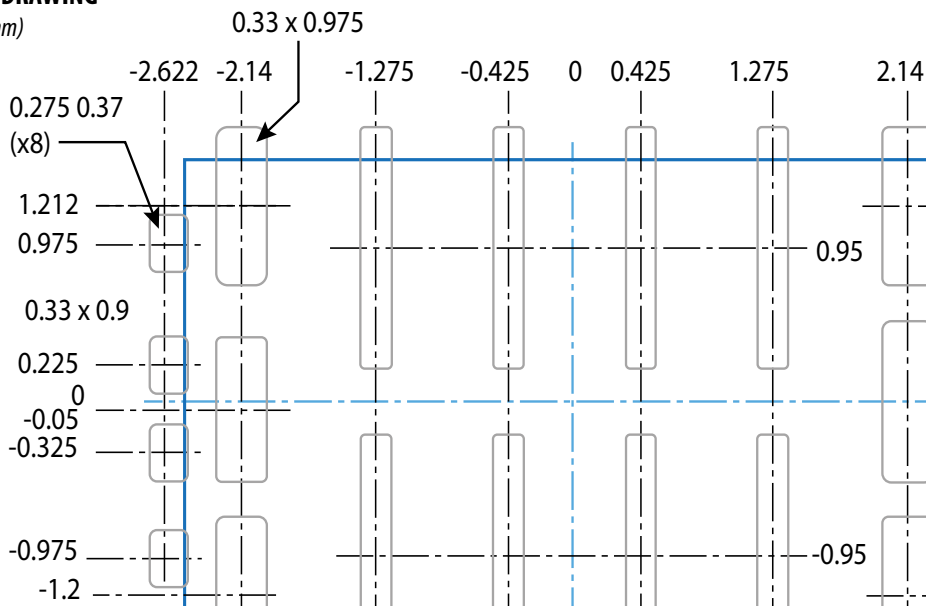

Recommended stencil should be 4 mil (100 μm) thick, must be laser cut, openings per drawing. Intended for use with SAC305 Type 4 solder, reference 88.5% metals content.

The corner has a radius of R60.

Split stencil design can be provided upon request, but EPC has tested this stencil design and not found any scooping issues.

**RECOMMENDED
COPPER DRAWING**
(units in mm)

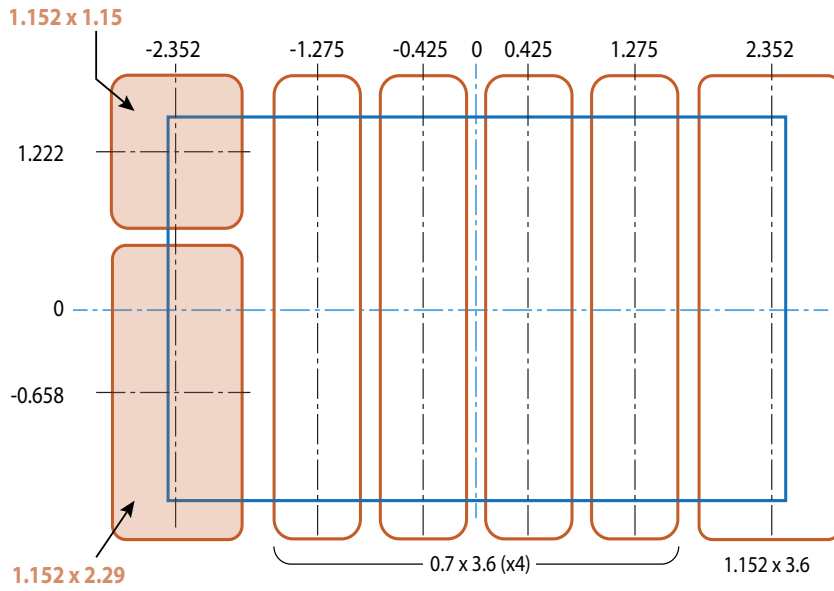

3D COMPOSITE

Legend:

Part outline

Lead frame

Paste

Mask

Copper

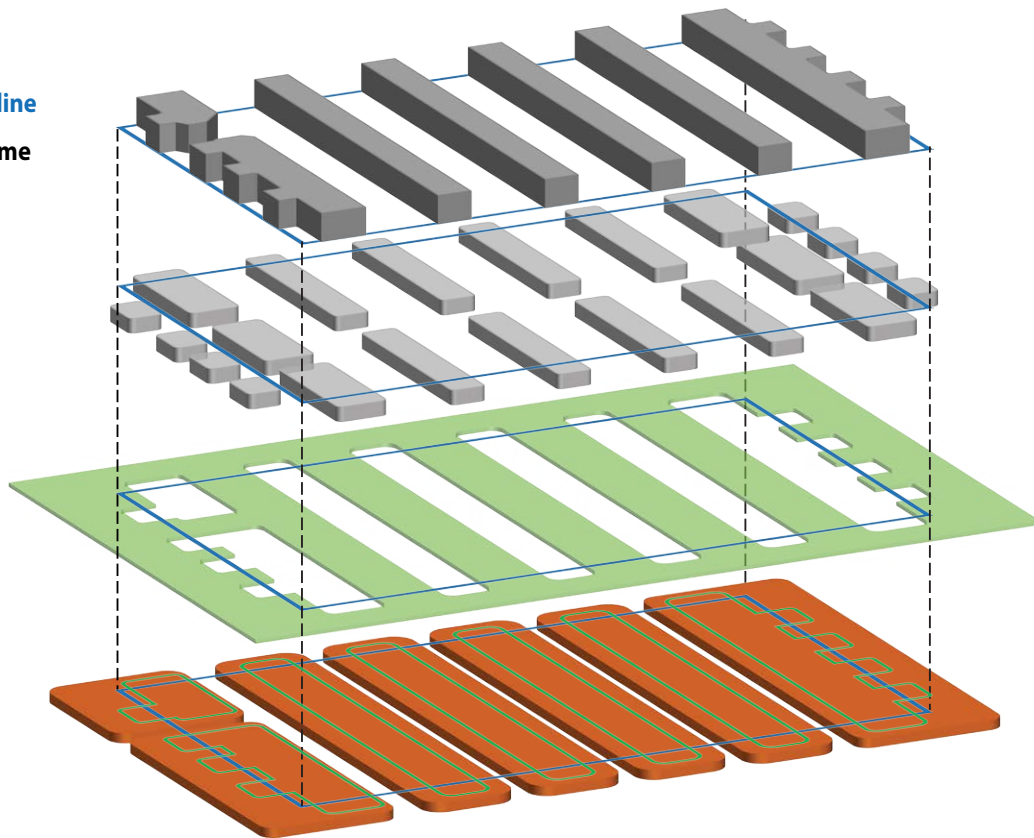

ADDITIONAL RESOURCES AVAILABLE

Solder mask defined pads are recommended for best reliability.

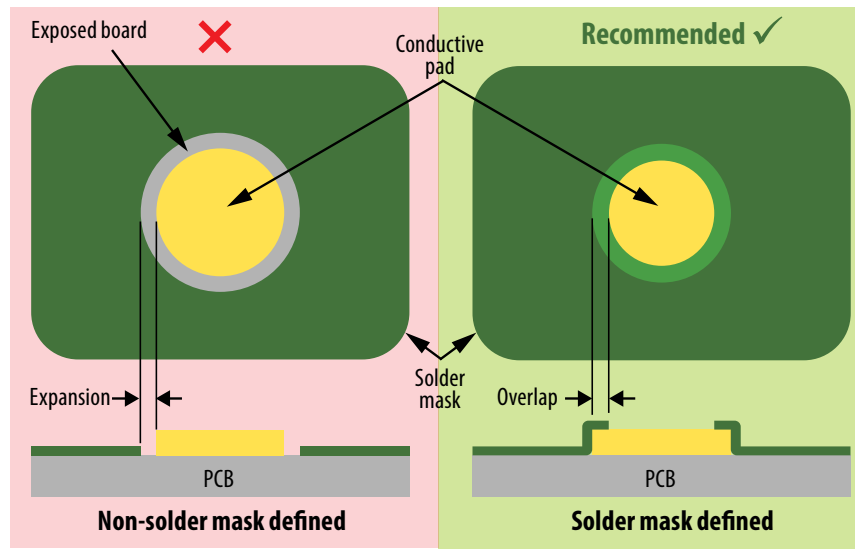

Figure 17: Solder mask defined versus non-solder mask defined pad

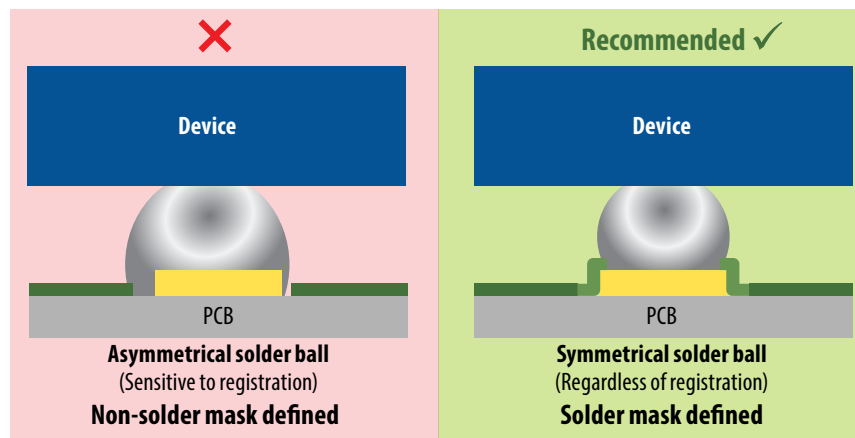

Figure 18: Effect of solder mask design on the solder ball symmetry

- Assembly resources – https://epc-co.com/epc/Portals/0/epc/documents/product-training/Appnote_GaNassembly.pdf
- Library of Altium footprints for production FETs and ICs – <https://epc-co.com/epc/documents/altium-files/EPC%20Altium%20Library.zip>
(for preliminary device Altium footprints, contact EPC)

Efficient Power Conversion Corporation (EPC) reserves the right to make changes without further notice to any products herein to improve reliability, function or design. EPC does not assume any liability arising out of the application or use of any product or circuit described herein; neither does it convey any license under its patent rights, nor the rights of others.

eGaN® is a registered trademark of Efficient Power Conversion Corporation.

EPC Patent Listing: <https://epc-co.com/epc/about-epc/patents>

Information subject to change without notice.