

## PolarP™ Power MOSFETs

P-Channel Enhancement Mode  
Avalanche Rated

**IXTA36P15P**  
**IXTP36P15P**  
**IXTQ36P15P**  
**IXTH36P15P**

$V_{DSS} = -150V$   
 $I_{D25} = -36A$   
 $R_{DS(on)} \leq 110m\Omega$

TO-263 AA (IXTA)

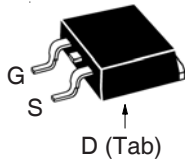

TO-220AB (IXTP)

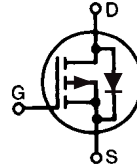
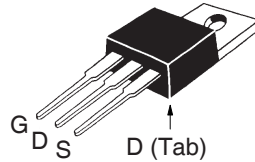

TO-3P (IXTQ)

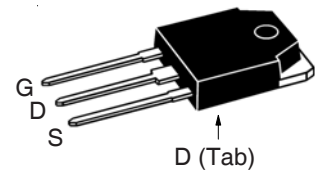

TO-247 (IXTH)

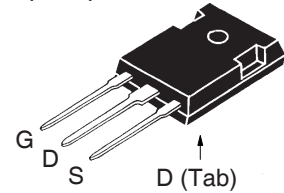

G = Gate      D = Drain  
S = Source    Tab = Drain

Symbol	Test Conditions	Maximum Ratings	
$V_{DSS}$	$T_J = 25^\circ C$ to $150^\circ C$	- 150	V
$V_{DGR}$	$T_J = 25^\circ C$ to $150^\circ C$ , $R_{GS} = 1M\Omega$	- 150	V
$V_{GSS}$	Continuous	$\pm 20$	V
$V_{GSM}$	Transient	$\pm 30$	V
$I_{D25}$	$T_C = 25^\circ C$	- 36	A
$I_{DM}$	$T_C = 25^\circ C$ , Pulse Width Limited by $T_{JM}$	- 90	A
$I_A$	$T_C = 25^\circ C$	- 36	A
$E_{AS}$	$T_C = 25^\circ C$	1.5	J
dv/dt	$I_S \leq I_{DM}$ , $V_{DD} \leq V_{DSS}$ , $T_J \leq 150^\circ C$	10	V/ns
$P_D$	$T_C = 25^\circ C$	300	W
$T_J$		-55 ... +150	$^\circ C$
$T_{JM}$		150	$^\circ C$
$T_{stg}$		-55 ... +150	$^\circ C$
$T_L$	1.6mm (0.062 in.) from Case for 10s	300	$^\circ C$
$T_{SOLD}$	Plastic Body for 10s	260	$^\circ C$
$M_d$	Mounting Torque (TO-3P, TO-220 & TO-247)	1.13/10	Nm/lb.in.
$F_C$	Mounting Force (TO-263)	10..65/2.2..14.6	N/lb.
Weight	TO-263	2.5	g
	TO-220	3.0	g
	TO-3P	5.5	g
	TO-247	6.0	g

Symbol	Test Conditions ( $T_J = 25^\circ C$ , Unless Otherwise Specified)	Characteristic Values		
		Min.	Typ.	Max.
$BV_{DSS}$	$V_{GS} = 0V$ , $I_D = -250 \mu A$	- 150		V
$V_{GS(th)}$	$V_{DS} = V_{GS}$ , $I_D = -250 \mu A$	- 2.5		- 4.5 V
$I_{GSS}$	$V_{GS} = \pm 20V$ , $V_{DS} = 0V$			$\pm 100$ nA
$I_{DSS}$	$V_{DS} = V_{DSS}$ , $V_{GS} = 0V$ $T_J = 125^\circ C$			-10 $\mu A$ - 250 $\mu A$
$R_{DS(on)}$	$V_{GS} = -10V$ , $I_D = 0.5 \cdot I_{D25}$ , Note 1			110 m $\Omega$

### Features

- International Standard Packages
- Rugged PolarP™ Process
- Avalanche Rated
- Low Package Inductance
- Fast Intrinsic Diode
- Dynamic dv/dt Rated
- Low  $R_{DS(ON)}$  and  $Q_G$
- Low Drain-to-Tab Capacitance

### Advantages

- Easy to Mount
- Space Savings
- High Power Density

### Applications

- High-Side Switching
- Push Pull Amplifiers
- DC Choppers
- Automatic Test Equipment
- Current Regulators

Symbol	Test Conditions ( $T_J = 25^\circ\text{C}$ , Unless Otherwise Specified)	Characteristic Values		
		Min.	Typ.	Max.
$g_{fs}$	$V_{DS} = -10\text{V}$ , $I_D = 0.5 \cdot I_{D25}$ , Note 1	11	19	S
$C_{iss}$	$V_{GS} = 0\text{V}$ , $V_{DS} = -25\text{V}$ , $f = 1\text{MHz}$		3100	pF
$C_{oss}$			610	pF
$C_{rss}$			100	pF
$t_{d(on)}$	<b>Resistive Switching Times</b> $V_{GS} = -10\text{V}$ , $V_{DS} = 0.5 \cdot V_{DSS}$ , $I_D = 0.5 \cdot I_{D25}$ $R_G = 3.3\Omega$ (External)		21	ns
$t_r$			31	ns
$t_{d(off)}$			36	ns
$t_f$			15	ns
$Q_{g(on)}$	$V_{GS} = -10\text{V}$ , $V_{DS} = 0.5 \cdot V_{DSS}$ , $I_D = 0.5 \cdot I_{D25}$		55	nC
$Q_{gs}$			20	nC
$Q_{gd}$			18	nC
$R_{thJC}$				0.42 $^\circ\text{C/W}$
$R_{thCS}$	(TO-3P, TO-247)		0.21	$^\circ\text{C/W}$
	(TO-220)		0.50	$^\circ\text{C/W}$

#### Source-Drain Diode

Symbol	Test Conditions ( $T_J = 25^\circ\text{C}$ , Unless Otherwise Specified)	Characteristic Values		
		Min.	Typ.	Max.
$I_S$	$V_{GS} = 0\text{V}$			-36 A
$I_{SM}$	Repetitive, Pulse Width Limited by $T_{JM}$			-140 A
$V_{SD}$	$I_F = -18\text{A}$ , $V_{GS} = 0\text{V}$ , Note 1			-3.3 V
$t_{rr}$	$I_F = -18\text{A}$ , $-di/dt = -100\text{A}/\mu\text{s}$ $V_R = -75\text{V}$ , $V_{GS} = 0\text{V}$		228	ns
$Q_{RM}$			2.0	$\mu\text{C}$
$I_{RM}$			-17.6	A

Note 1: Pulse test,  $t \leq 300\mu\text{s}$ , duty cycle,  $d \leq 2\%$ .

IXYS Reserves the Right to Change Limits, Test Conditions, and Dimensions.

IXYS MOSFETs and IGBTs are covered by one or more of the following U.S. patents:

4,835,592	4,931,844	5,049,961	5,237,481	6,162,665	6,404,065 B1	6,683,344	6,727,585	7,005,734 B2	7,157,338B2
4,860,072	5,017,508	5,063,307	5,381,025	6,259,123 B1	6,534,343	6,710,405 B2	6,759,692	7,063,975 B2	
4,881,106	5,034,796	5,187,117	5,486,715	6,306,728 B1	6,583,505	6,710,463	6,771,478 B2	7,071,537	

### TO-263 Outline

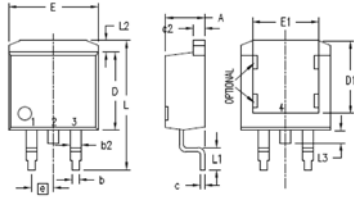

1 - Gate  
2,4 - Drain  
3 - Source

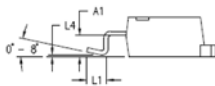

SYM	INCHES		MILLIMETERS	
	MIN	MAX	MIN	MAX
A	.160	.190	4.06	4.83
A1	.080	.110	2.03	2.79
b	.020	.039	0.51	0.99
b2	.045	.055	1.14	1.40
c	.016	.029	0.40	0.74
c2	.045	.055	1.14	1.40
D	.340	.380	8.64	9.65
D1	.315	.350	8.00	8.89
E	.380	.410	9.65	10.41
E1	.245	.320	6.22	8.13
e	.100 BSC		2.54 BSC	
L	.575	.625	14.61	15.88
L1	.090	.110	2.29	2.79
L2	.040	.055	1.02	1.40
L3	.050	.070	1.27	1.78
L4	0	.005	0	0.13

### TO-220 Outline

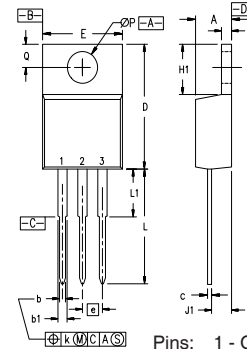

Pins: 1 - Gate  
2 - Drain  
3 - Source

SYM	INCHES		MILLIMETERS	
	MIN	MAX	MIN	MAX
A	.170	.190	4.32	4.83
b	.025	.040	0.64	1.02
b1	.045	.065	1.15	1.65
c	.014	.022	0.35	0.56
D	.580	.630	14.73	16.00
E	.390	.420	9.91	10.66
e	.100 BSC		2.54 BSC	
F	.045	.055	1.14	1.40
H1	.230	.270	5.85	6.85
J1	.090	.110	2.29	2.79
k	0	.015	0	0.38
L	.500	.550	12.70	13.97
L1	.110	.230	2.79	5.84
ØP	.139	.161	3.53	4.08
Q	.100	.125	2.54	3.18

### TO-3P Outline

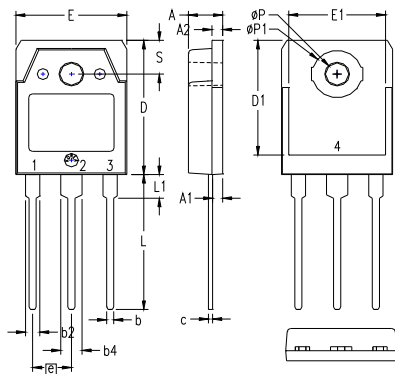

Pins: 1 - Gate 2,4 - Drain  
3 - Source

SYM	INCHES		MILLIMETERS	
	MIN	MAX	MIN	MAX
A	.185	.193	4.70	4.90
A1	.051	.059	1.30	1.50
A2	.057	.065	1.45	1.65
b	.035	.045	0.90	1.15
b2	.075	.087	1.90	2.20
b4	.114	.126	2.90	3.20
c	.022	.031	0.55	0.80
D	.780	.791	19.80	20.10
D1	.665	.677	16.90	17.20
E	.610	.622	15.50	15.80
E1	.531	.539	13.50	13.70
e	.215 BSC		5.45 BSC	
L	.779	.795	19.80	20.20
L1	.134	.142	3.40	3.60
ØP	.126	.134	3.20	3.40
ØP1	.272	.280	6.90	7.10
S	.193	.201	4.90	5.10

All metal area are tin plated.

### TO-247 Outline

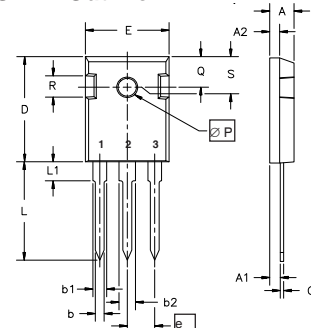

Pins: 1 - Gate 2 - Drain  
3 - Source

Dim.	Millimeter		Inches	
	Min.	Max.	Min.	Max.
A	4.7	5.3	.185	.209
A <sub>1</sub>	2.2	2.54	.087	.102
A <sub>2</sub>	2.2	2.6	.059	.098
b	1.0	1.4	.040	.055
b <sub>1</sub>	1.65	2.13	.065	.084
b <sub>2</sub>	2.87	3.12	.113	.123
C	.4	.8	.016	.031
D	20.80	21.46	.819	.845
E	15.75	16.26	.610	.640
e	5.20	5.72	0.205	0.225
L	19.81	20.32	.780	.800
L1		4.50		.177
ØP	3.55	3.65	.140	.144
Q	5.89	6.40	0.232	0.252
R	4.32	5.49	.170	.216

Fig. 1. Output Characteristics @  $T_J = 25^\circ\text{C}$

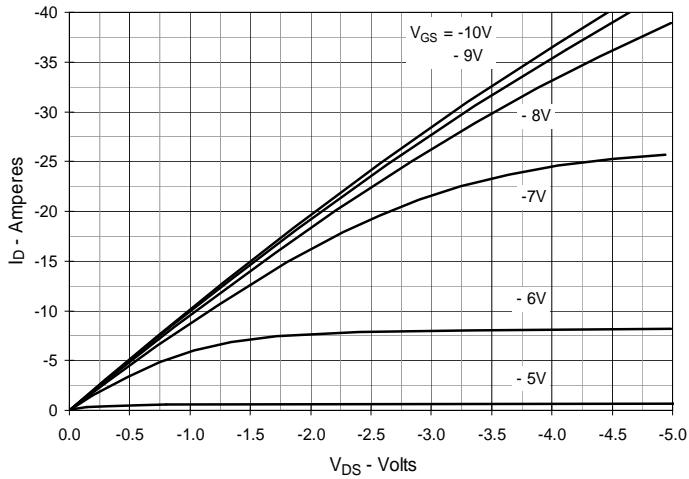

Fig. 2. Extended Output Characteristics @  $T_J = 25^\circ\text{C}$

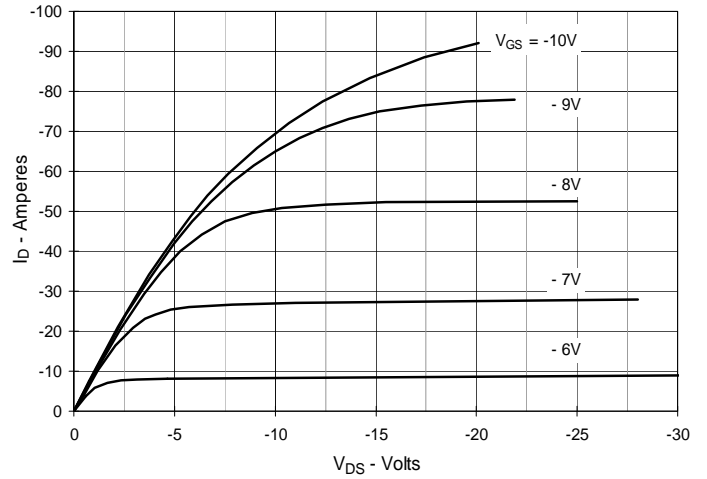

Fig. 3. Output Characteristics @  $T_J = 125^\circ\text{C}$

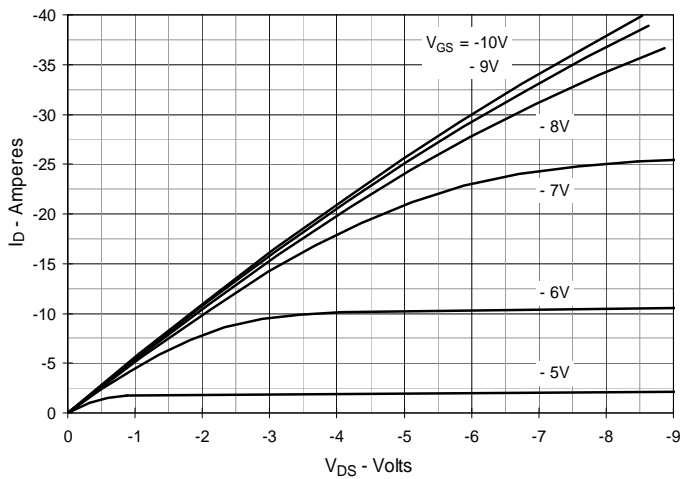

Fig. 4.  $R_{DS(on)}$  Normalized to  $I_D = -18\text{A}$  Value vs. Junction Temperature

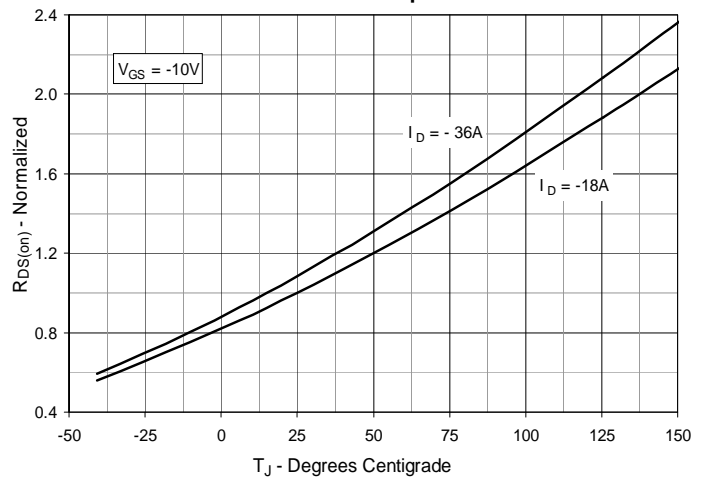

Fig. 5.  $R_{DS(on)}$  Normalized to  $I_D = -18\text{A}$  Value vs. Drain Current

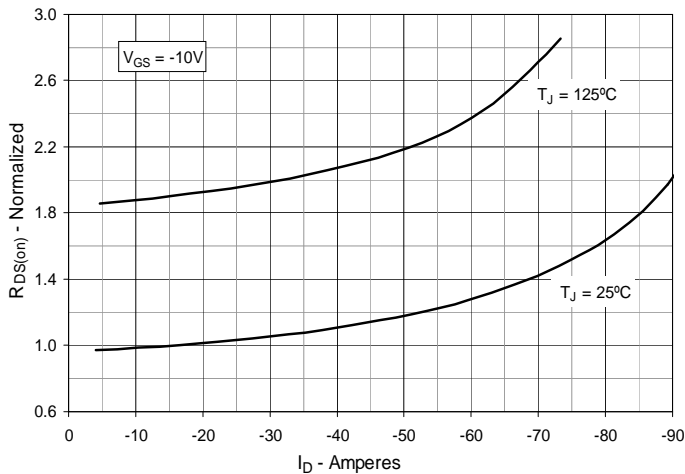

Fig. 6. Maximum Drain Current vs. Case Temperature

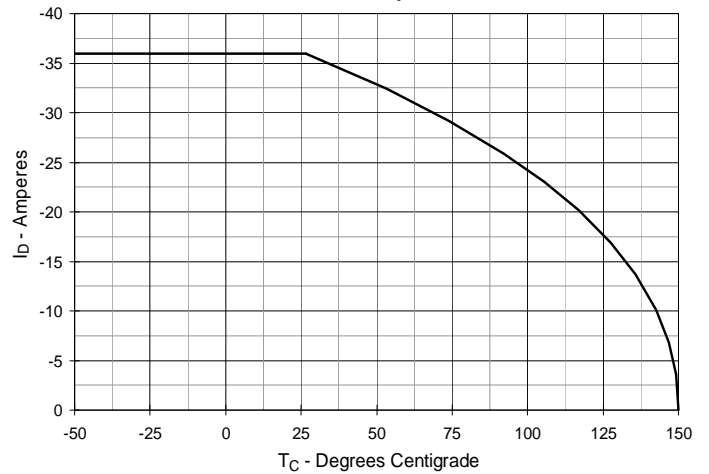

Fig. 7. Input Admittance

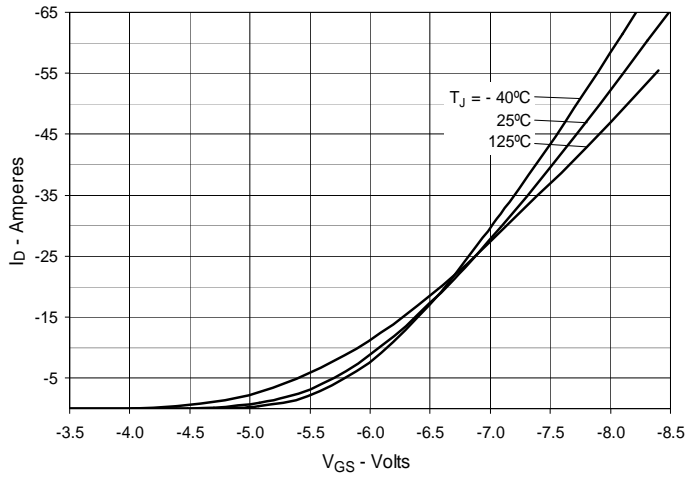

Fig. 8. Transconductance

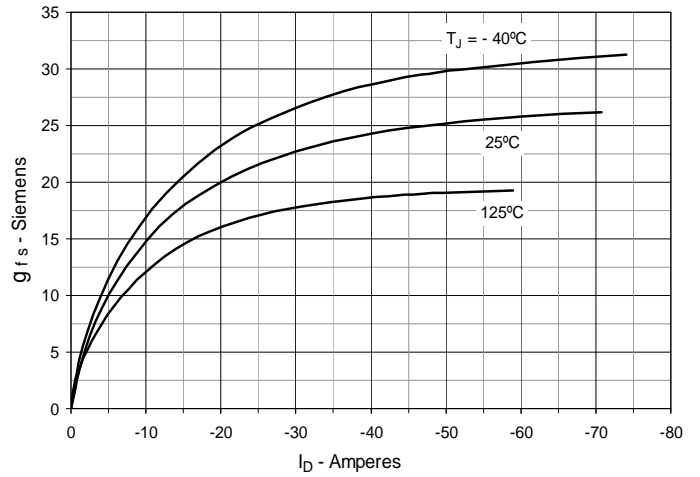

Fig. 9. Forward Voltage Drop of Intrinsic Diode

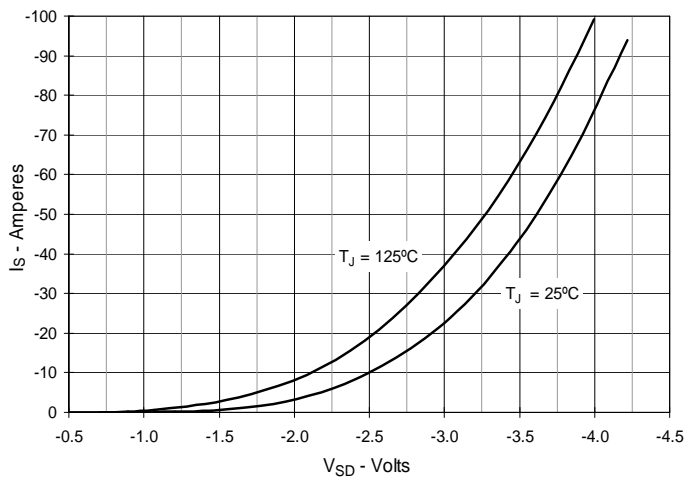

Fig. 10. Gate Charge

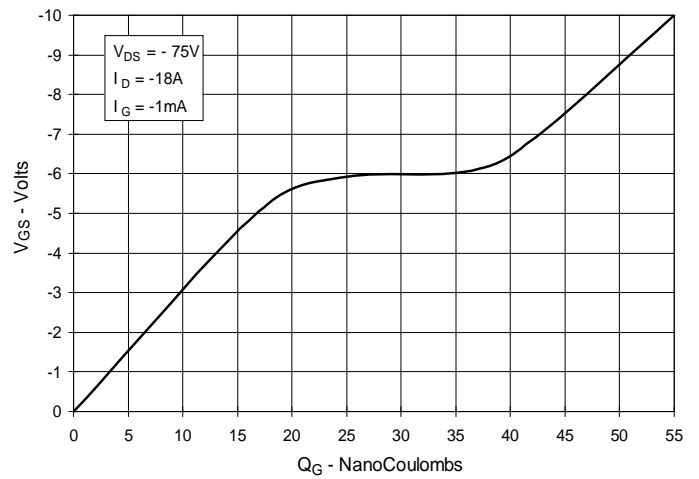

Fig. 11. Capacitance

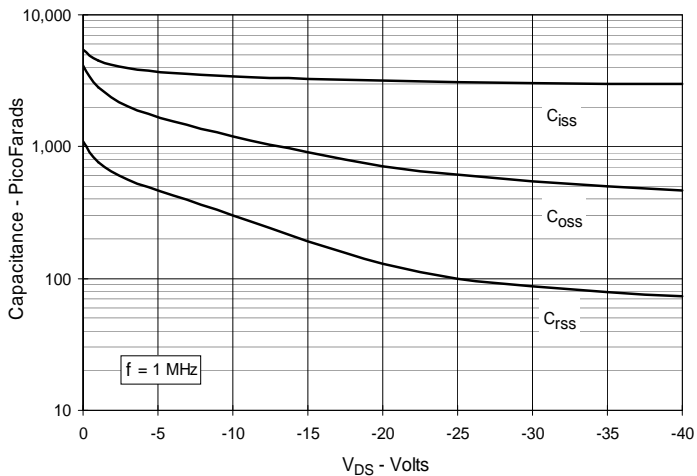

Fig. 12. Forward-Bias Safe Operating Area

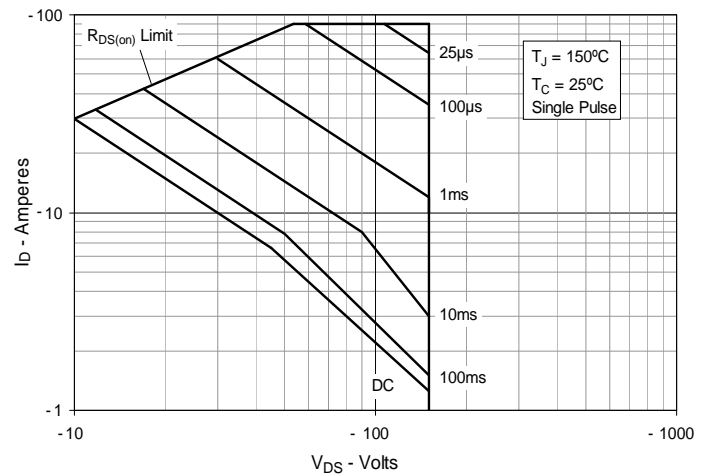
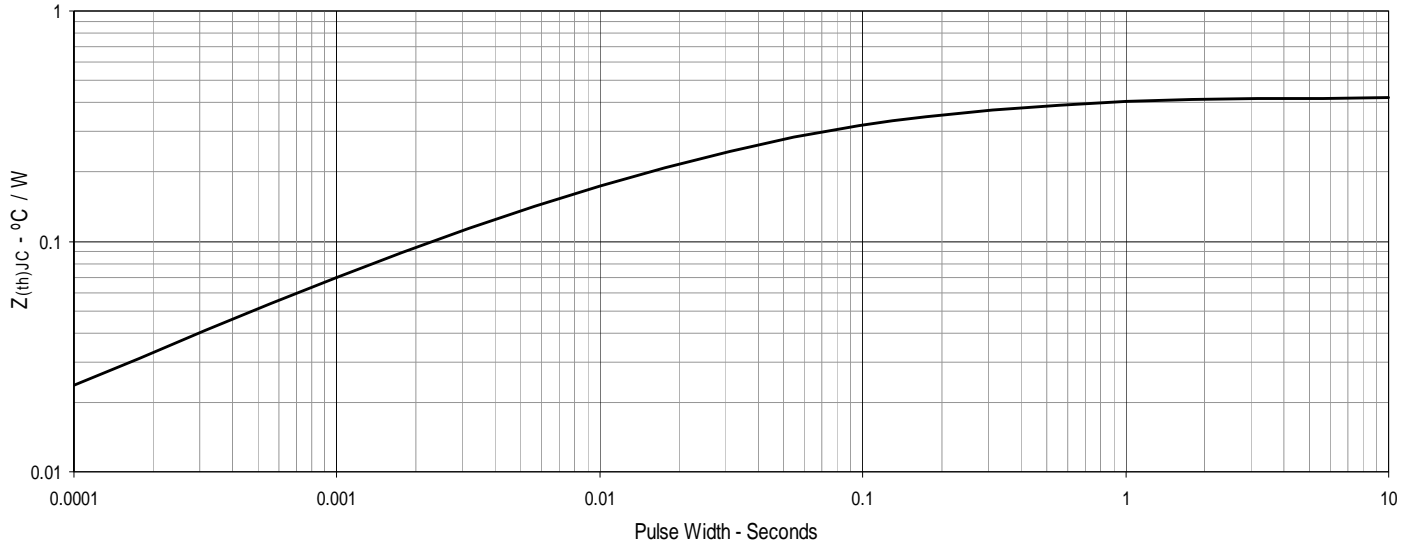

Fig. 13. Maximum Transient Thermal Impedance





---

Disclaimer Notice - Information furnished is believed to be accurate and reliable. However, users should independently evaluate the suitability of and test each product selected for their own applications. Littelfuse products are not designed for, and may not be used in, all applications. Read complete Disclaimer Notice at [www.littelfuse.com/disclaimer-electronics](http://www.littelfuse.com/disclaimer-electronics).