

2SB1202/2SD1802

Bipolar Transistor

(-)50 V, (-)3 A, Low $V_{CE(sat)}$ (PNP)NPN
Single TP/TP-FA

Features

- Adoption of FBET and MBIT Processes
- Large Current Capacitance and Wide ASO
- Low Collector to Emitter Saturation Voltage
- Fast Switching Speed
- Small and Slim Package Making it Easy to Make
2SB1202/2SD1802-used Sets Smaller
- These Devices are Pb-Free and are RoHS Compliant

Applications

- Voltage Regulators, Relay Drivers, Lamp Drivers, Electrical Equipment

ABSOLUTE MAXIMUM RATINGS at $T_A = 25^\circ\text{C}$

Parameter	Symbol	Conditions	Ratings	Unit
Collector to Base Voltage	V_{CBO}		(-)60	V
Collector to Emitter Voltage	V_{CEO}		(-)50	V
Emitter to Base Voltage	V_{EBO}		(-)6	V
Collector Current	I_C		(-)3	A
Collector Current (Pulse)	I_{CP}		(-)6	A
Collector Dissipation	P_C		1	W
		$T_C = 25^\circ\text{C}$	15	W
Junction Temperature	T_J		150	$^\circ\text{C}$
Storage Temperature	T_{STG}		- 55 to +150	$^\circ\text{C}$

Stresses exceeding those listed in the Maximum Ratings table may damage the device. If any of these limits are exceeded, device functionality should not be assumed, damage may occur and reliability may be affected.



ON Semiconductor®

www.onsemi.com

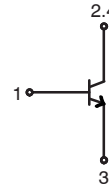

(For PNP, the polarity is reversed.)

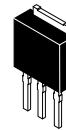

IPAK / TP
CASE 369AJ

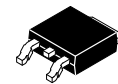

DPAK / TP-FA
CASE 369AH

MARKING DIAGRAM

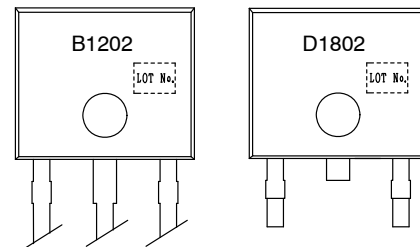

ORDERING INFORMATION

See detailed ordering and shipping information on page 8 of this data sheet.

2SB1202/2SD1802

ELECTRICAL CHARACTERISTICS at $T_A = 25^\circ\text{C}$

Parameter	Symbol	Conditions	Ratings			Unit
			Min	Typ	Max	
Collector Cutoff Current	I_{CBO}	$V_{CB} = (-)40\text{ V}, I_E = 0\text{ A}$			(-1)	μA
Emitter Cutoff Current	I_{EBO}	$V_{EB} = (-)4\text{ V}, I_C = 0\text{ A}$			(-1)	μA
DC Current Gain	h_{FE1}	$V_{CE} = (-)2\text{ V}, I_C = (-)100\text{ mA}$	100*		560*	
	h_{FE2}	$V_{CE} = (-)2\text{ V}, I_C = (-)3\text{ A}$	35			
Gain-Bandwidth Product	f_T	$V_{CE} = (-)10\text{ V}, I_C = (-)50\text{ mA}$		150		MHz
Output Capacitance	C_{ob}	$V_{CB} = (-)10\text{ V}, f = 1\text{ MHz}$		(39)25		pF
Collector to Emitter Saturation Voltage	$V_{CE(sat)}$	$I_C = (-)2\text{ A}, I_B = (-)100\text{ mA}$		(-0.35)0.19	(-0.7)0.5	V
Base to Emitter Saturation Voltage	$V_{BE(sat)}$	$V_{CE} = (-)2\text{ V}, I_C = (-)100\text{ mA}$		(-)0.94	(-)1.2	V
Collector to Base Breakdown Voltage	$V_{(BR)CBO}$	$I_C = (-)10\text{ }\mu\text{A}, I_E = 0\text{ A}$	(-)60			V
Collector to Emitter Breakdown Voltage	$V_{(BR)CEO}$	$I_C = (-)1\text{ mA}, R_{BE} = \Omega$	(-)50			V
Emitter to Base Breakdown Voltage	$V_{(BR)EBO}$	$I_E = (-)10\text{ }\mu\text{A}, I_C = 0\text{ A}$	(-)6			V
Turn-On Time	t_{on}	See specified Test Circuit		70		ns
Storage Time	t_{stg}			(450)650		ns
Fall Time	t_f			35		ns

Product parametric performance is indicated in the Electrical Characteristics for the listed test conditions, unless otherwise noted. Product performance may not be indicated by the Electrical Characteristics if operated under different conditions.

*The 2SB1202/2SD1802 are classified by 100 mA h_{FE} as follows :

Rank	R	S	T	U
h_{FE}	100 to 200	140 to 280	200 to 400	280 to 560

Switching Time Test Circuit

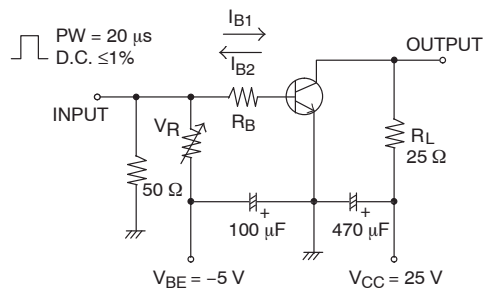

$I_C = 10\text{ mA}, I_{B1} = -10\text{ mA}, I_{B2} = 1\text{ mA}$
For PNP, the polarity is reversed.

2SB1202/2SD1802

TYPICAL CHARACTERISTICS

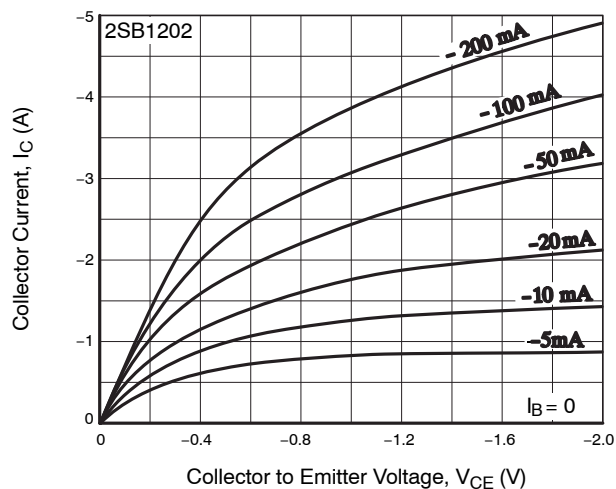

Figure 1. $I_C - V_{CE}$

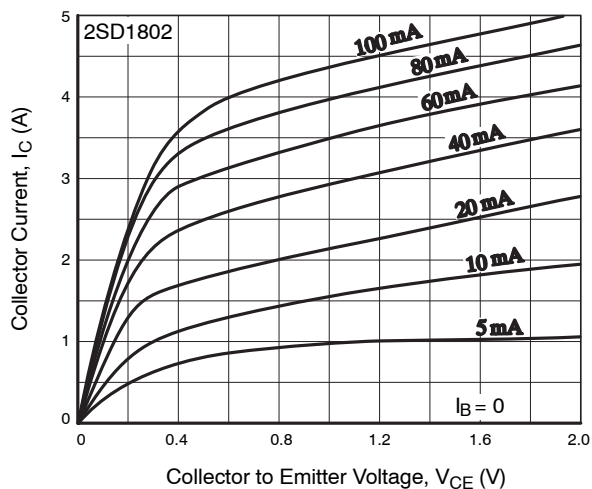

Figure 2. $I_C - V_{CE}$

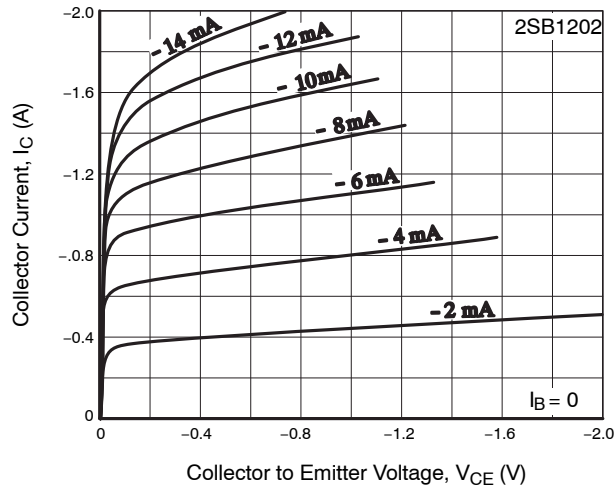

Figure 3. $I_C - V_{CE}$

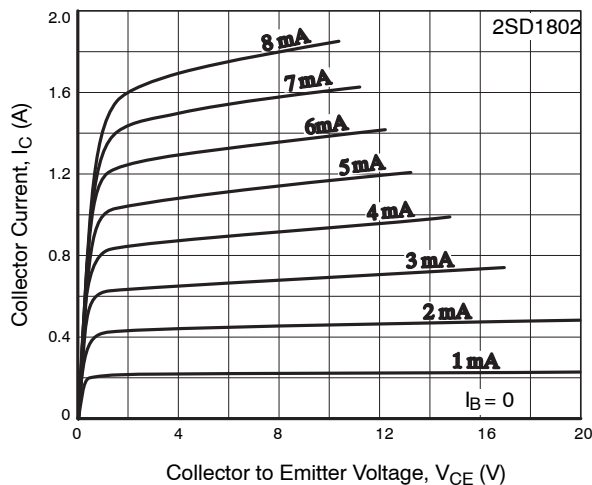

Figure 4. $I_C - V_{CE}$

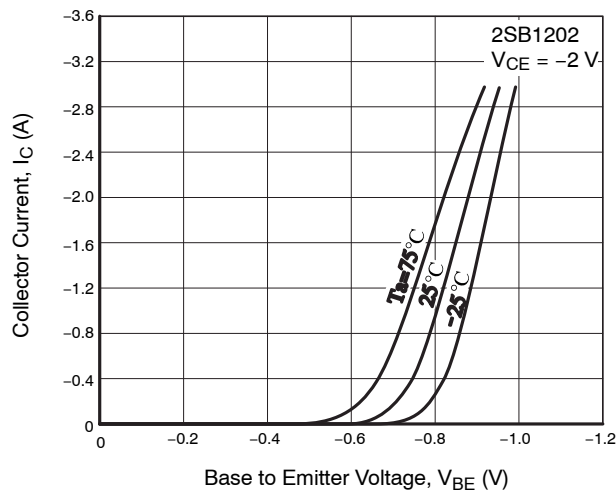

Figure 5. $I_C - V_{BE}$

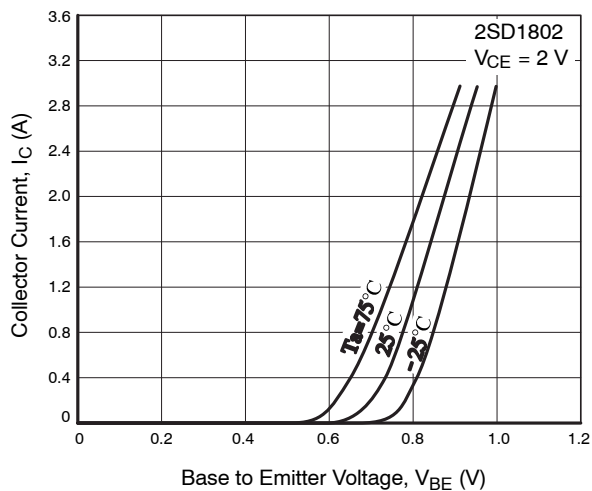

Figure 6. $I_C - V_{BE}$

2SB1202/2SD1802

TYPICAL CHARACTERISTICS (continued)

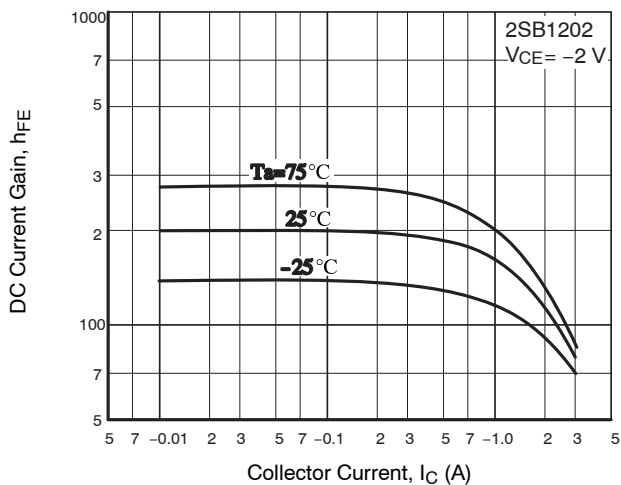

Figure 7. $h_{FE} - I_C$

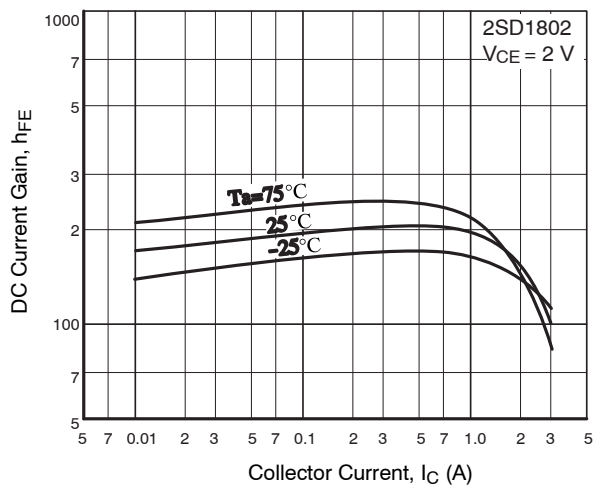

Figure 8. $h_{FE} - I_C$

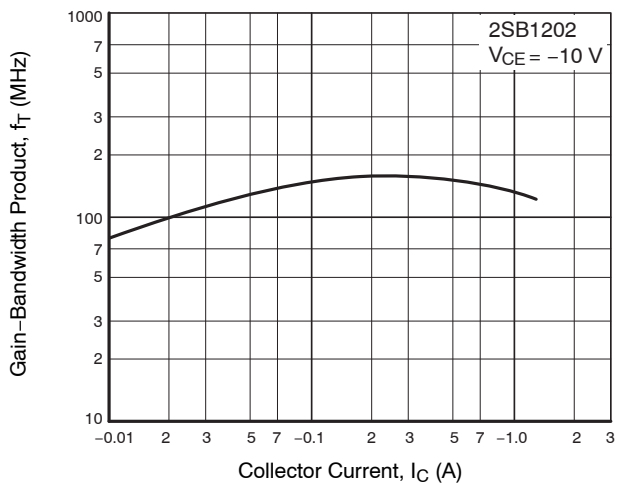

Figure 9. $f_T - I_C$

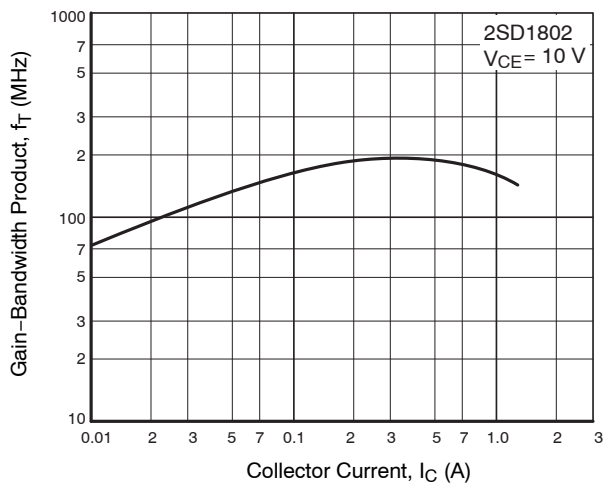

Figure 10. $f_T - I_C$

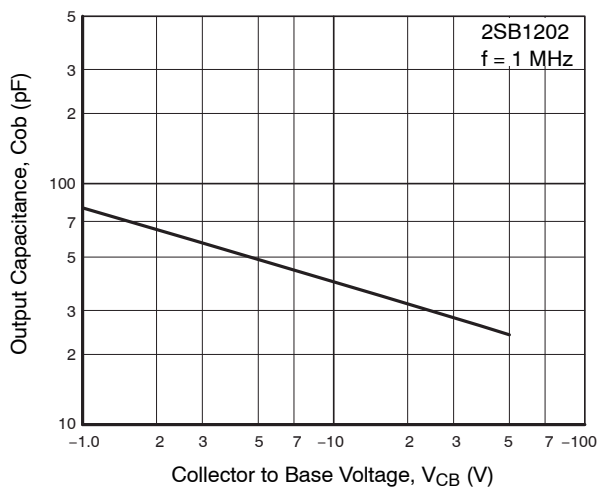

Figure 11. $C_{ob} - V_{CB}$

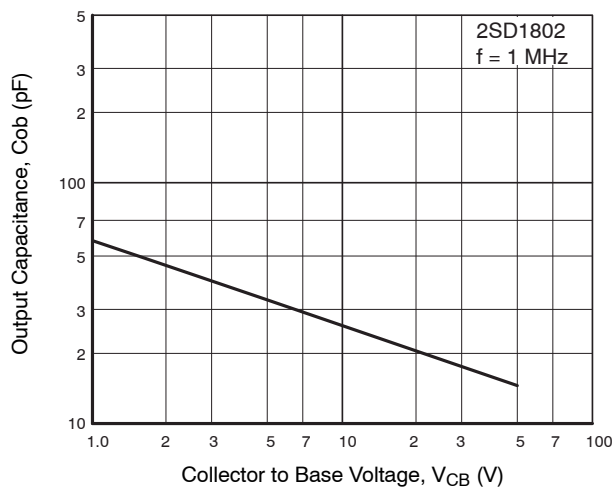

Figure 12. $C_{ob} - V_{CB}$

2SB1202/2SD1802

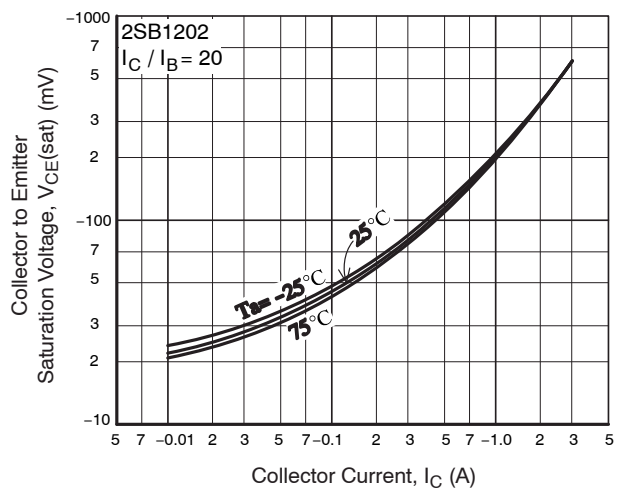

Figure 13. $V_{CE(sat)} - I_C$

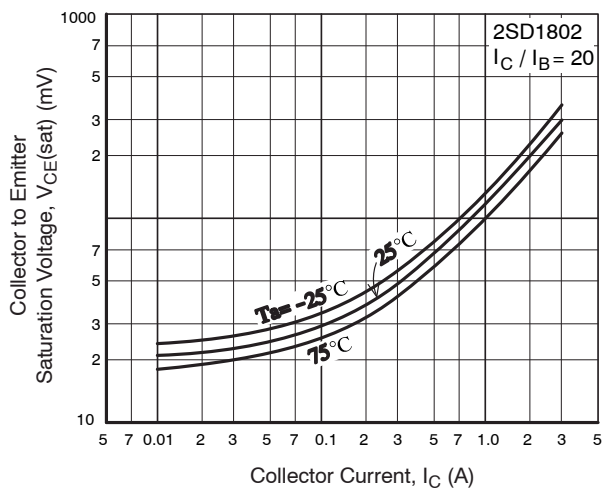

Figure 14. $V_{CE(sat)} - I_C$

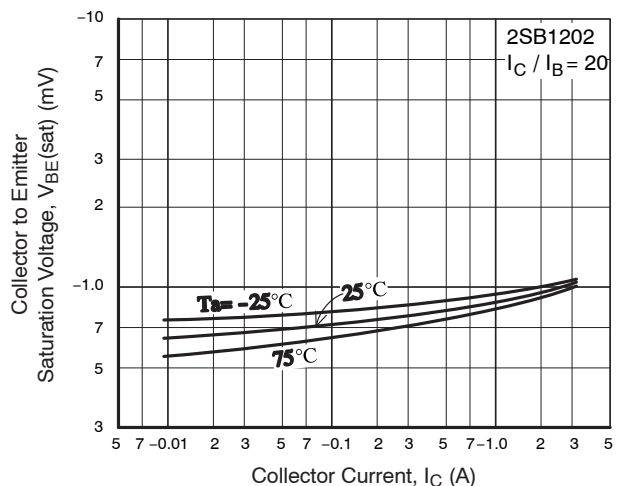

Figure 15. $V_{BE(sat)} - I_C$

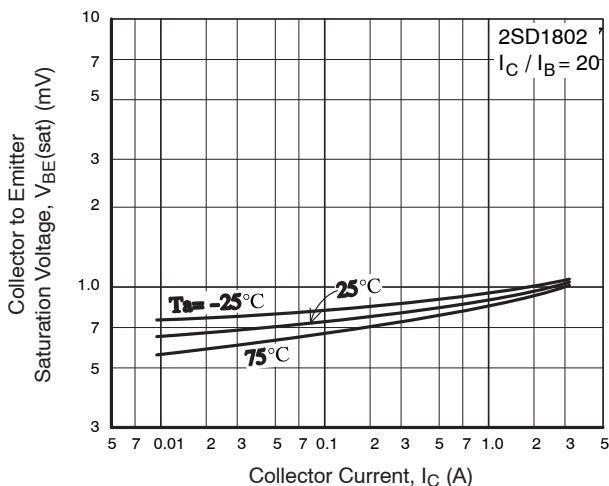

Figure 16. $V_{BE(sat)} - I_C$

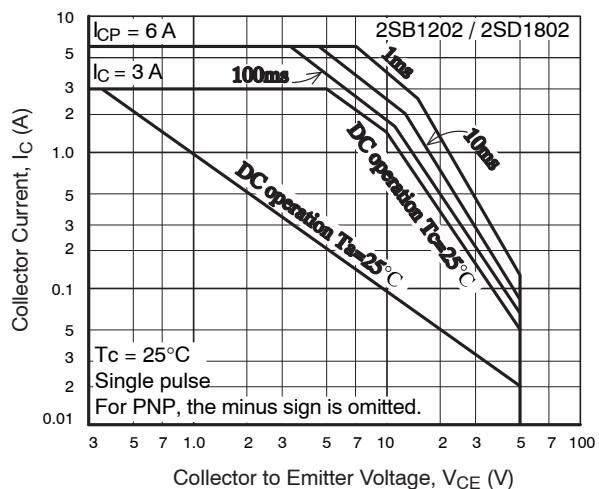

Figure 17. ASO

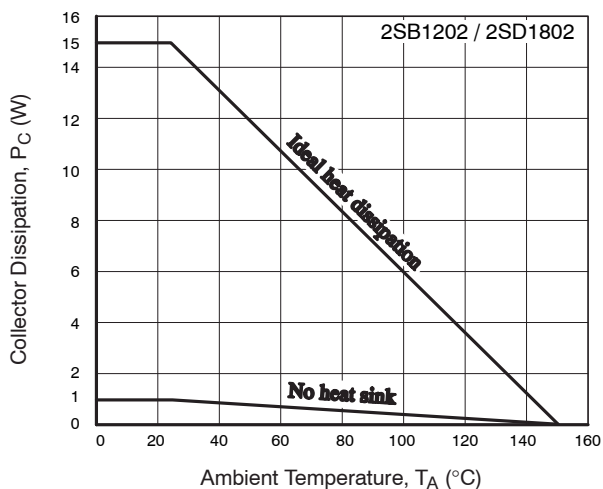

Figure 18. $P_C - T_A$

2SB1202/2SD1802

ORDERING INFORMATION

Device	Package	Shipping†	memo
2SB1202S-E	TP	500pcs./bag	Pb-Free
2SB1202T-E	TP	500pcs./bag	
2SD1802S-E	TP	500pcs./bag	
2SD1802T-E	TP	500pcs./bag	
2SB1202S-TL-E	TP-FA	700pcs./reel	
2SB1202T-TL-E	TP-FA	700pcs./reel	
2SD1802S-TL-E	TP-FA	700pcs./reel	
2SD1802T-TL-E	TP-FA	700pcs./reel	

†For information on tape and reel specifications, including part orientation and tape sizes, please refer to our Tape and Reel Packaging Specifications Brochure, BRD8011/D.

DPAK / TP-FA
CASE 369AH
ISSUE O

DATE 30 JAN 2012

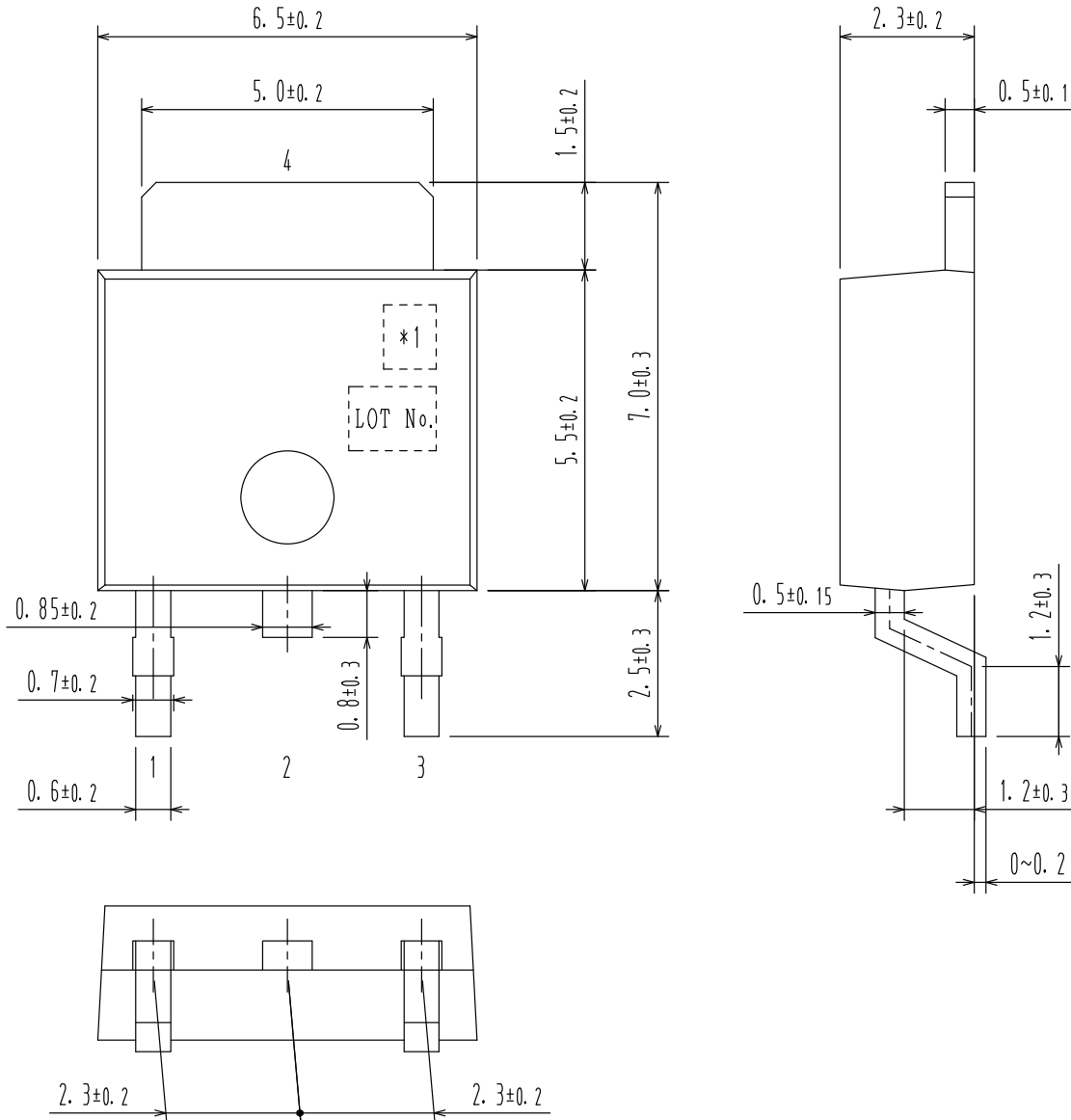

Pin 2 is idle pin with electrical designation only carried.

- 1:
- 2:
- 3:
- *1: Lot indication 4:

DOCUMENT NUMBER:	98AON66236E	Electronic versions are uncontrolled except when accessed directly from the Document Repository. Printed versions are uncontrolled except when stamped "CONTROLLED COPY" in red.
DESCRIPTION:	DPAK / TP-FA	PAGE 1 OF 1

onsemi and Onsemi are trademarks of Semiconductor Components Industries, LLC dba onsemi or its subsidiaries in the United States and/or other countries. onsemi reserves the right to make changes without further notice to any products herein. onsemi makes no warranty, representation or guarantee regarding the suitability of its products for any particular purpose, nor does onsemi assume any liability arising out of the application or use of any product or circuit, and specifically disclaims any and all liability, including without limitation special, consequential or incidental damages. onsemi does not convey any license under its patent rights nor the rights of others.

IPAK / TP
CASE 369AJ
ISSUE 0

DATE 30 JAN 2012

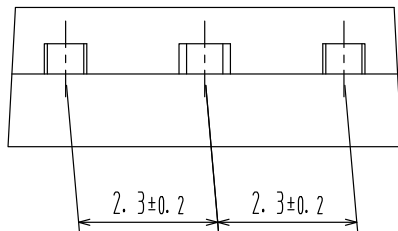
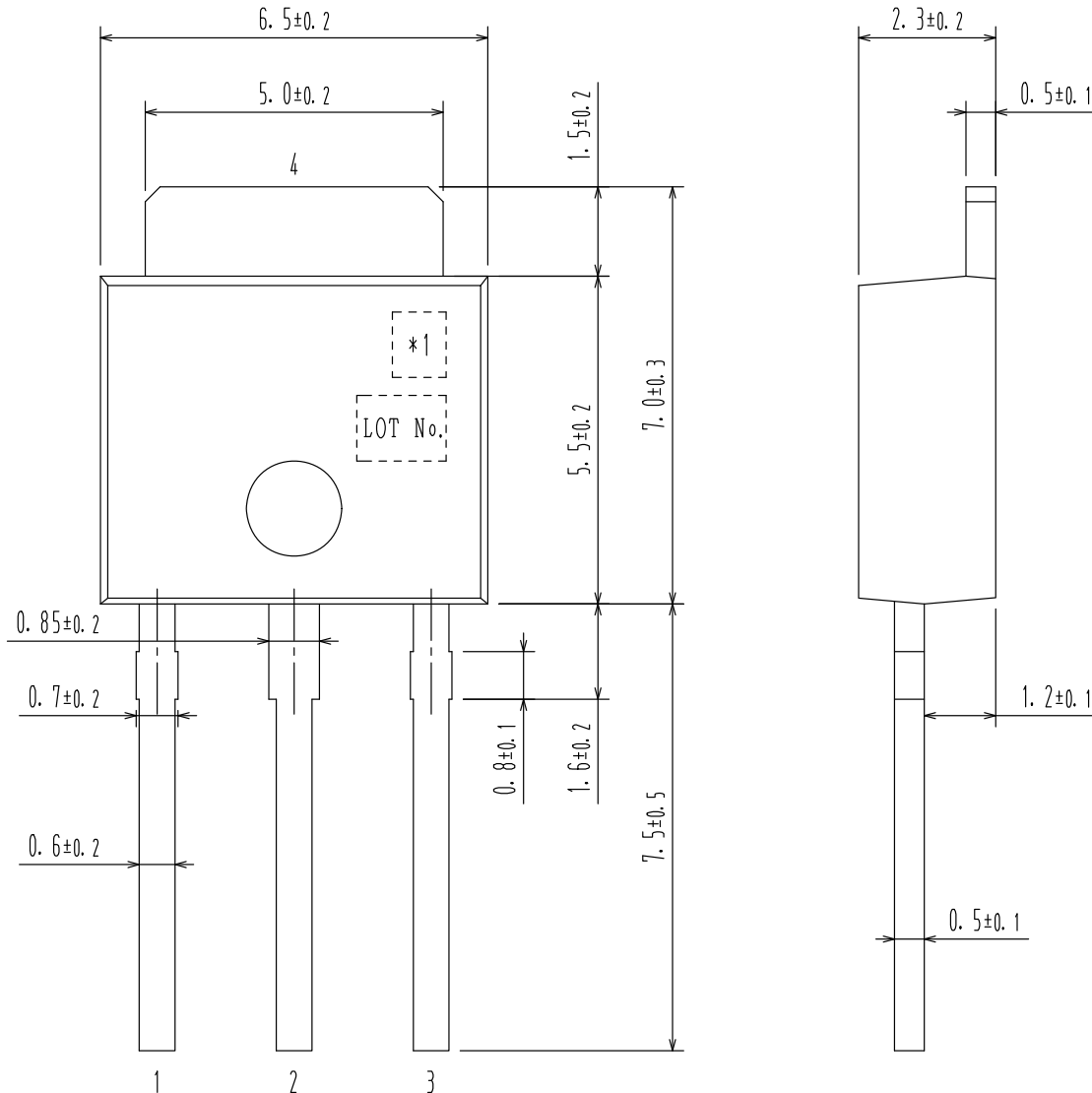

- 1:
- 2:
- 3:
- 4:

*1: Lot indication

DOCUMENT NUMBER:	98AON66237E	Electronic versions are uncontrolled except when accessed directly from the Document Repository. Printed versions are uncontrolled except when stamped "CONTROLLED COPY" in red.
DESCRIPTION:	IPAK / TP	PAGE 1 OF 1

onsemi and Onsemi are trademarks of Semiconductor Components Industries, LLC dba onsemi or its subsidiaries in the United States and/or other countries. onsemi reserves the right to make changes without further notice to any products herein. onsemi makes no warranty, representation or guarantee regarding the suitability of its products for any particular purpose, nor does onsemi assume any liability arising out of the application or use of any product or circuit, and specifically disclaims any and all liability, including without limitation special, consequential or incidental damages. onsemi does not convey any license under its patent rights nor the rights of others.

onsemi, **Onsemi**, and other names, marks, and brands are registered and/or common law trademarks of Semiconductor Components Industries, LLC dba "**onsemi**" or its affiliates and/or subsidiaries in the United States and/or other countries. **onsemi** owns the rights to a number of patents, trademarks, copyrights, trade secrets, and other intellectual property. A listing of **onsemi**'s product/patent coverage may be accessed at www.onsemi.com/site/pdf/Patent-Marking.pdf. **onsemi** reserves the right to make changes at any time to any products or information herein, without notice. The information herein is provided "as-is" and **onsemi** makes no warranty, representation or guarantee regarding the accuracy of the information, product features, availability, functionality, or suitability of its products for any particular purpose, nor does **onsemi** assume any liability arising out of the application or use of any product or circuit, and specifically disclaims any and all liability, including without limitation special, consequential or incidental damages. Buyer is responsible for its products and applications using **onsemi** products, including compliance with all laws, regulations and safety requirements or standards, regardless of any support or applications information provided by **onsemi**. "Typical" parameters which may be provided in **onsemi** data sheets and/or specifications can and do vary in different applications and actual performance may vary over time. All operating parameters, including "Typicals" must be validated for each customer application by customer's technical experts. **onsemi** does not convey any license under any of its intellectual property rights nor the rights of others. **onsemi** products are not designed, intended, or authorized for use as a critical component in life support systems or any FDA Class 3 medical devices or medical devices with a same or similar classification in a foreign jurisdiction or any devices intended for implantation in the human body. Should Buyer purchase or use **onsemi** products for any such unintended or unauthorized application, Buyer shall indemnify and hold **onsemi** and its officers, employees, subsidiaries, affiliates, and distributors harmless against all claims, costs, damages, and expenses, and reasonable attorney fees arising out of, directly or indirectly, any claim of personal injury or death associated with such unintended or unauthorized use, even if such claim alleges that **onsemi** was negligent regarding the design or manufacture of the part. **onsemi** is an Equal Opportunity/Affirmative Action Employer. This literature is subject to all applicable copyright laws and is not for resale in any manner.

ADDITIONAL INFORMATION

TECHNICAL PUBLICATIONS:

Technical Library: www.onsemi.com/design/resources/technical-documentation
onsemi Website: www.onsemi.com

ONLINE SUPPORT: www.onsemi.com/support

For additional information, please contact your local Sales Representative at www.onsemi.com/support/sales