

215 Series

5x20 mm, Time-Lag Fuse



Description

The 215 Series is a 5x20mm Time-lag, surge-withstand, ceramic body cartridge fuse that is designed to IEC specifications.

Features

- Conforms to EN/IEC/K/J 60127-1 and EN/IEC/K/J 60127-2
- High breaking capacity
- Meets Standard Sheet 5 of IEC 60127-2 as a Time-Lag fuse
- RoHS compliant and lead-free
- Recognized to UL/CSA/NMX 248-1 and UL/CSA/NMX 248-14
- Conforms to GB 9364.1 and GB 9364.2
- CE Mark indicates compliance with Low-Voltage and RoHS Directives.

Additional Information



Resources



Accessories



Samples

Applications

Used as supplementary protection in appliance or utilization equipment to provide individual protection for components or internal circuits.

Electrical Characteristics for Series

| % of Ampere Rating | Ampere Rating | Opening Time |
|--------------------|-----------------|----------------------------------|
| 150% | 0.125A – 0.800A | 60 minutes, Minimum |
| | 1A – 3.15A | 60 minutes, Minimum |
| | 4A – 6.3A | 60 minutes, Minimum |
| | 8A – 20A | 30 minutes, Minimum |
| 210% | 0.125A – 0.800A | 30 minutes, Maximum |
| | 1A – 3.15A | 30 minutes, Maximum |
| | 4A – 6.3A | 30 minutes, Maximum |
| | 8A – 20A | 30 minutes, Maximum |
| 275% | 0.125A – 0.800A | 0.25 sec. Min.; 80 secs. Max. |
| | 1A – 3.15A | 0.75 sec. Min.; 80 secs. Max. |
| | 4A – 6.3A | 0.75 sec. Min.; 80 secs. Max. |
| | 8A – 20A | 0.75 sec. Min.; 80 secs. Max. |
| 400% | 0.125A – 0.800A | 0.05 sec., Min.; 5 secs. Max. |
| | 1A – 3.15A | 0.095 sec., Min.; 5 secs. Max. |
| | 4A – 6.3A | 0.150 sec., Min.; 5 secs. Max. |
| | 8A – 20A | 0.150 sec., Min.; 5 secs. Max. |
| 1000% | 0.125A – 0.800A | 0.005 sec., Min.; .150 sec. Max. |
| | 1A – 3.15A | 0.010 sec., Min.; .150 sec. Max. |
| | 4A – 6.3A | 0.010 sec., Min.; .150 sec. Max. |
| | 8A – 20A | 0.010 sec., Min.; .150 sec. Max. |

Agency Approvals

| Agency | Agency File Number | Ampere Range | |
|--------|---|---|--------------------------------|
| PS E | Cartridge: NBK080205-E10480A NBK250702-E10480E NBK100408-JP1021A | 1A – 5A 6.3A – 15A 16A – 20A | |
| | Leaded: NBK080205-E10480B NBK250702-E10480F NBK100408-JP1021B | 1A – 5A 6.3A – 15A 16A – 20A | |
| CCC | 2020970207000067 | 0.125A-10A | |
| C | SU05001-2011B SU05001-10001 SU05001-10002 SU05001-2012B | 1A – 2.5A 3.15A – 6.3A 8A 4A - 10A | |
| | cUL us | E10480 | 0.125A - 20A |
| | SF | 29862 | 0.5A – 12A |
| | S | SE-S-2101268 | 0.125A-12A 15A*, 16A*, 20A* |
| D'E | 40013521 | 0.2A – 8A *10A | |
| VDE | 40016610 | *12A | |
| Heart | KM41462 | 0.200A – 10A | |
| A | J50248091 J50258578 | 10A 16A, 20A | |
| | CE | N/A | 0.125A – 20A |

* Approved for cartridge versions only

215 Series

5×20 mm, Time-Lag Fuse

Electrical Characteristic Specifications by Item

| Amp Code | Amp Rating | Voltage Rating (V) | Interrupting Rating ⁺ | Nominal Cold Resistance (Ohms) | Nominal Melting I ² t (A ² sec) | Maximum Voltage Drop at Rated Current (mV) | Maximum Power Dissipation at 1.5I _n (W) | Agency Approvals | | | | | | | | | | |
|----------|------------|--------------------|----------------------------------|--------------------------------|---|--|--|------------------|-----|-----|-----|-------|----|----|----|-----|-----|----|
| | | | | | | | | UL | CSA | CCC | CEC | UL US | UL | UL | UL | VDE | VDE | CE |
| .125 | 0.125 | 250 | 1500 A @ 250 VAC | 11.4455 | 0.0330 | 2600 | 1.6 | - | - | x | - | x | - | x | - | - | - | x |
| .160 | 0.16 | 250 | | 7.1000 | 0.0465 | 2400 | 1.6 | - | - | x | - | x | - | x | - | - | - | x |
| .200 | 0.2 | 250 | | 1.8400 | 0.340 | 2100 | 1.6 | x | - | x | - | x | - | x | x | - | - | x |
| .250 | 0.25 | 250 | | 1.2400 | 0.545 | 1500 | 1.6 | x | - | x | - | x | - | x | x | - | - | x |
| .315 | 0.315 | 250 | | 0.8800 | 0.975 | 1100 | 1.6 | x | - | x | - | x | - | x | x | - | - | x |
| .400 | 0.4 | 250 | | 0.5825 | 1.325 | 1000 | 1.6 | x | - | x | - | x | - | x | x | - | - | x |
| .500 | 0.5 | 250 | | 1.1675 | 0.420 | 850 | 1.6 | x | - | x | - | x | x | x | x | - | - | x |
| .630 | 0.63 | 250 | | 0.7200 | 0.635 | 650 | 1.6 | x | - | x | - | x | x | x | x | - | - | x |
| .800 | 0.8 | 250 | | 0.4675 | 0.975 | 500 | 1.6 | x | - | x | - | x | x | x | x | - | - | x |
| 001. | 1 | 250 | | 0.1515 | 1.520 | 350 | 2.5 | x | x | x | x | x | x | x | x | - | - | x |
| 1.25 | 1.25 | 250 | | 0.1074 | 3.200 | 300 | 2.5 | x | x | x | x | x | x | x | x | - | - | x |
| 016 | 1.6 | 250 | | 0.0707 | 6.830 | 200 | 2.5 | x | x | x | x | x | x | x | x | - | - | x |
| 002. | 2 | 250 | | 0.0566 | 11.680 | 190 | 2.5 | x | x | x | x | x | x | x | x | - | - | x |
| 02.5 | 2.5 | 250 | | 0.0386 | 22.290 | 180 | 2.5 | x | x | x | x | x | x | x | x | - | - | x |
| 3.15 | 3.15 | 250 | | 0.0283 | 43.255 | 140 | 4 | x | x | x | x | x | x | x | x | - | - | x |
| 004. | 4 | 250 | | 0.0185 | 46.960 | 100 | 4 | x | x | x | x | x | x | x | x | - | - | x |
| 005. | 5 | 250 | | 0.0153 | 66.095 | 100 | 4 | x | x | x | x | x | x | x | x | - | - | x |
| 06.3 | 6.3 | 250 | | 0.0108 | 128.750 | 100 | 4 | x | x | x | x | x | x | x | x | - | - | x |
| 008. | 8 | 250 | | 0.0092 | 209.880 | 100 | 4 | x | x | x | x | x | x | x | x | - | - | x |
| 010. | 10 | 250 | | 0.0066 | 333.565 | 100 | 4 | x | x | x | x | x | x | x | x* | - | x | x |
| 012. | 12 | 250 | 0.0061 | 515.500 | 100 | 4 | - | x | - | - | x | x | x | - | x* | - | x | |
| 015. | 15 | 250 | 500 A @ 250Vac | 0.0033 | 1237.0 | N/A** | N/A** | - | x | - | - | x | - | x* | - | - | - | x |
| 016. | 16 | 250 | 250Vac | 0.0031 | 1408.0 | N/A** | N/A** | - | x | - | - | x | - | x* | - | - | x | x |
| 020. | 20 | 250 | 400 A @ 250Vac | 0.0023 | 2600.0 | N/A** | N/A** | - | x | - | - | x | - | x* | - | - | x | x |

* Approval for cartridge versions only
 ** Please contact Littelfuse for details on these parameters
 + Interrupting Rating may differ based on Agency Approval. See Agency Approval certificate for more details.
 1A to 2A have an IR: 100A@500VAC, 4A to 6-3A have the IR: 100A@305 VAC and 1000A@72VDC
 I2t test at 10x rated current.
 10A have an IR:1000A@300Vac for cURus

Temperature Re-rating Curve

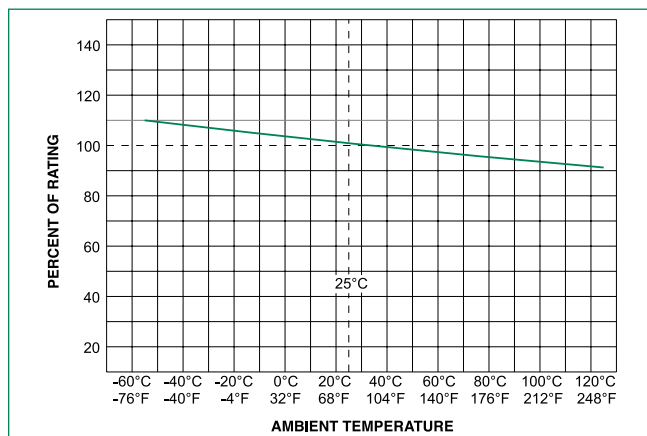

Product Characteristics

| | |
|------------------------------|--|
| Materials | Body: Ceramic Cap: Nickel-plated Brass Leads: Tin-plated Copper |
| Terminal Strength | MIL-STD-202, Method 211, Test Condition A |
| Solderability | MIL-STD-202 Method 208 |
| Product Marking | Cap 1: Brand logo, current and voltage ratings Cap 2: Agency approval markings |
| Operating Temperature | -55°C to +125°C |
| Thermal Shock | MIL-STD-202, Method 107, Test Condition B (5 cycles, -65°C to +125°C) |
| Vibration | MIL-STD-202, Method 201 |
| Humidity | MIL-STD-202, Method 103, Test Condition A (High RH (95%) and elevated temp (40°C) for 240 hours) |
| Salt Spray | MIL-STD-202, Method 101, Test Condition B |

215 Series

5x20 mm, Time-Lag Fuse

Average Time Current Curves

T-C Curves for 125mA to 800mA only

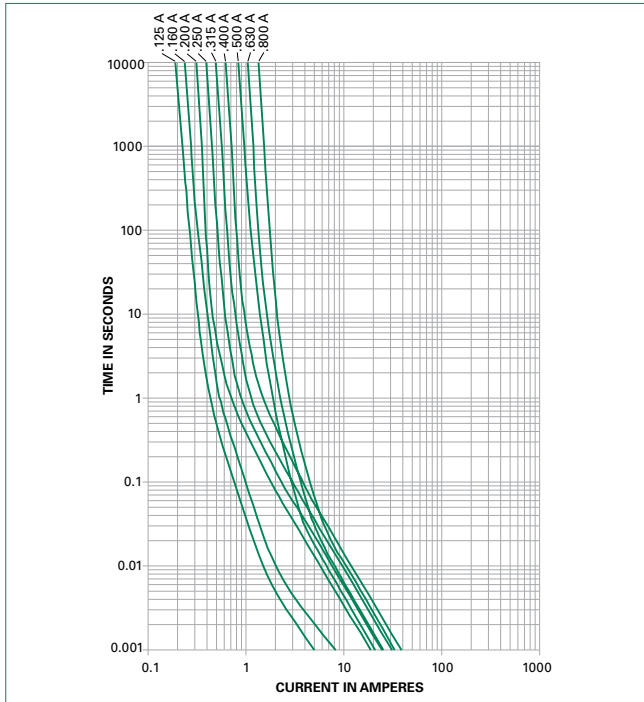

T-C Curves for 1A to 20A only

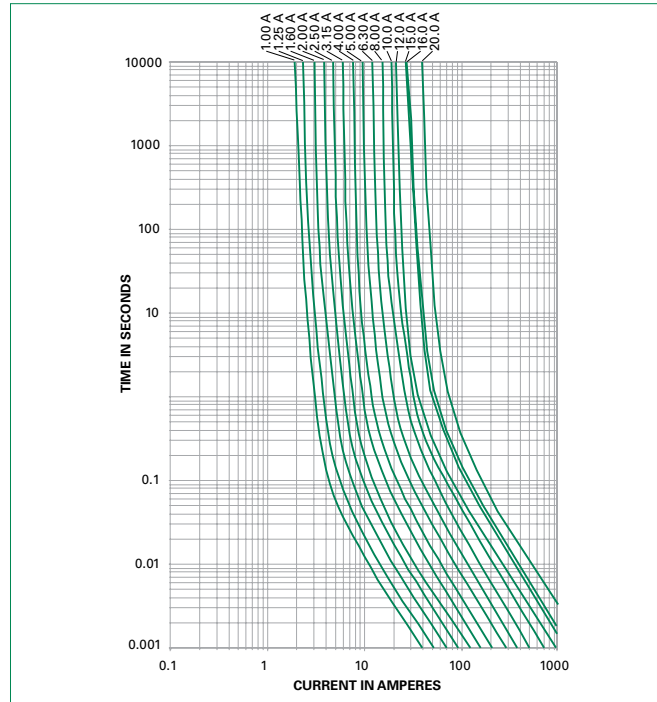

Soldering Parameters - Wave Soldering

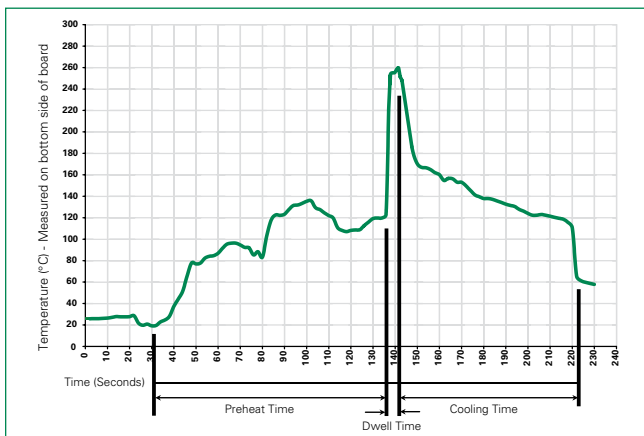

Different values of A and B available, please contact the Littelfuse sales representative in your region:

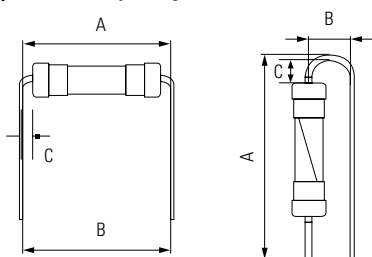

Recommended Process Parameters:

| Wave Parameter | Lead-Free Recommendation |
|--|-----------------------------------|
| Preheat: (Depends on Flux Activation Temperature) | (Typical Industry Recommendation) |
| Temperature Minimum: | 100° C |
| Temperature Maximum: | 150° C |
| Preheat Time: | 60-180 seconds |
| Solder Pot Temperature: | 260° C Maximum |
| Solder Dwell Time: | 2-5 seconds |

Recommended Hand-Solder Parameters:

Solder Iron Temperature: 350° C +/- 5° C
 Heating Time: 5 seconds max.

Note: These devices are not recommended for IR or Convection Reflow process.

For the pigtailed fuse, please follow the recommendations below for axial lead forming and mounting into PCB:

Lead forming:

The distance C between cap flat surface and axial lead shall be greater than 1.0 mm.

PCB mounting:

The distance between PCB and fuse cap is recommended to be a minimum of 1.5 mm.

215 Series

5×20 mm, Time-Lag Fuse

Dimensions

All dimensions in mm

0215.125P
to
0215020P

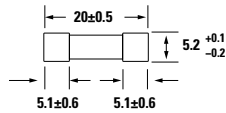

0215.125XEP
to
0215.800XEP

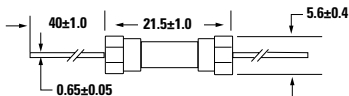

0215001.XEP
to
0215020.XEP

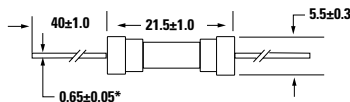

Notes:

- * Ratings above 6.3 A have 0.8 ± 0.05 diameter lead;
- * Ratings above 12 A have 1.2 ± 0.05 diameter lead.

Part Numbering System

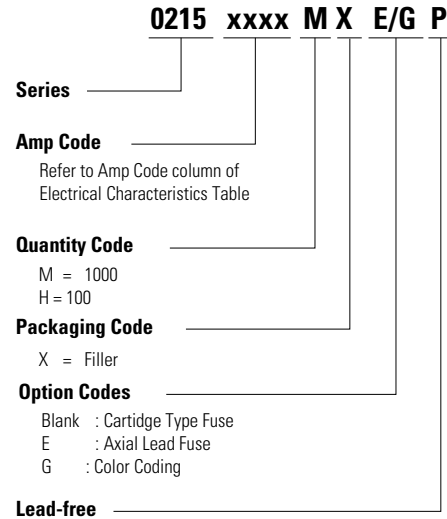

Packaging

| Packaging Option | Packaging Specification | Quantity | Quantity & Packaging Code | Taping Width |
|-----------------------|-------------------------|----------|---------------------------|------------------|
| 215 Series | | | | |
| Bulk | N/A | 1000 | MX | N/A |
| Bulk | N/A | 1000 | MXE | N/A |
| Reel and Tape | N/A | 1000 | MRET1 | T1=53mm (2.087") |
| Bulk and Color Coding | N/A | 1000 | MXG | N/A |
| Bulk | N/A | 1000 | MXB | N/A |
| Bulk | N/A | 100 | HX | N/A |

Recommended Accessories

| Accessory Type | Series | Description | Max Application Voltage | Max Application Amperage |
|----------------|-------------------------|---|-------------------------|--------------------------|
| Holder | 345_ISF | Panel Mount Shock-Safe Fuseholder | 250 | 10 |
| | 345 | Shock-Safe Fuseholder with PC Mount, Solder Mount and Panel Mount options | | 20 |
| | 830 | PC Mount Shock-Safe Miniature Fuseholder | | 16 |
| Block | 520 | Metric OMNI-BLOK® Fuse Block | | 10 |
| | 646 | PC Mount Miniature Fuse Block | | 6.3 |
| | 658 | Surface Mount Miniature Fuse Block | | 10 |
| Clip | 520_W | PC Mount Miniature Fuse Clip | 6.3 | |
| | 111 | PC Board Mount Fuse Clip | 10 | |
| | 445 | PC Board Mount Fuse Clip | 10 | |

Disclaimer Notice - Information furnished is believed to be accurate and reliable. However, users should independently evaluate the suitability of and test each product selected for their own applications. Littelfuse products are not designed for, and may not be used in, all applications. Read complete Disclaimer Notice at: www.littelfuse.com/disclaimer-electronics.