



# TMS88B-ACC360

TMS/TMM88

INCLINATION SENSORS

**SICK**  
Sensor Intelligence.



Illustration may differ

### Ordering information

Type	Part no.
TMS88B-ACC360	1073788

Other models and accessories → [www.sick.com/TMS\\_TMM88](http://www.sick.com/TMS_TMM88)



### Detailed technical data

#### Performance

<b>Number of axis</b>	1
<b>Measuring range</b>	360°
<b>Resolution</b>	0.01°
<b>Static measurement accuracy</b>	Typ. ± 0.15°, max. ± 0.25°
<b>Temperature coefficient (zero point)</b>	Typ. ±0.008°/K <sup>1)</sup>
<b>Limit frequency</b>	0.1 Hz ... 25 Hz, 8. range (with digital filter)
<b>Sampling rate</b>	80 Hz

<sup>1)</sup> Referring to the temperature of 25 °C.

#### Interfaces

<b>Communication interface</b>	CANopen
<b>Device profile</b>	CiA DS-301 (Application layer) CiA DS-410 v4.2.0 (Device profile for inclination sensors) CiA DSP-305 (Layer Setting Service (LSS) and protocols)
<b>Address setting</b>	0...127, default: 10
<b>Data transmission rate (baud rate)</b>	10 kbit/s ... 1,000 kbit/s, Default: automatic baud rate detection
<b>Status information</b>	CANopen status via status LED
<b>Bus termination</b>	Via external terminator
<b>Parameterising data</b>	Zerose Limit frequency Preset value Inverting of counting direction
<b>Programmable/configurable</b>	Over PGT-12-Pro
<b>Initialization time</b>	80 ms

#### Electrical data

<b>Connection type</b>	Male connector, M12, 5-pin
<b>Supply voltage</b>	8 V DC ... 36 V DC
<b>Current consumption</b>	< 16 mA @ 24 V
<b>Reverse polarity protection</b>	✓
<b>MTTFd: mean time to dangerous failure</b>	663 years (EN ISO 13849-1) <sup>1)</sup>

<sup>1)</sup> This product is a standard product and does not constitute a safety component as defined in the Machinery Directive. Calculation based on nominal load of components, average ambient temperature 40°C, frequency of use 8760 h/a. All electronic failures are considered hazardous. For more information, see document no. 8015532.

## Mechanical data

<b>Dimensions</b>	58 mm x 90 mm x 31 mm
<b>Weight</b>	200 g
<b>Housing material</b>	Aluminum

## Ambient data

<b>EMC</b>	EN 61326-1, EN ISO 14982, EN ISO 13309
<b>Enclosure rating</b>	IP65 IP67
<b>Operating temperature range</b>	-40 °C ... +80 °C
<b>Storage temperature range</b>	-40 °C ... +85 °C
<b>Resistance to shocks</b>	100 g, 6 ms (according to EN 60068-2-27)
<b>Resistance to vibration</b>	10 g, 10 Hz ... 2,000 Hz (EN 60068-2-6)

## Classifications

<b>ECLASS 5.0</b>	27270790
<b>ECLASS 5.1.4</b>	27270790
<b>ECLASS 6.0</b>	27270790
<b>ECLASS 6.2</b>	27270790
<b>ECLASS 7.0</b>	27270790
<b>ECLASS 8.0</b>	27270790
<b>ECLASS 8.1</b>	27270790
<b>ECLASS 9.0</b>	27270790
<b>ECLASS 10.0</b>	27271101
<b>ECLASS 11.0</b>	27271101
<b>ECLASS 12.0</b>	27271101
<b>ETIM 5.0</b>	EC001852
<b>ETIM 6.0</b>	EC001852
<b>ETIM 7.0</b>	EC001852
<b>ETIM 8.0</b>	EC001852
<b>UNSPSC 16.0901</b>	41111613

### Dimensional drawing (Dimensions in mm (inch))

TMx88B-AxC

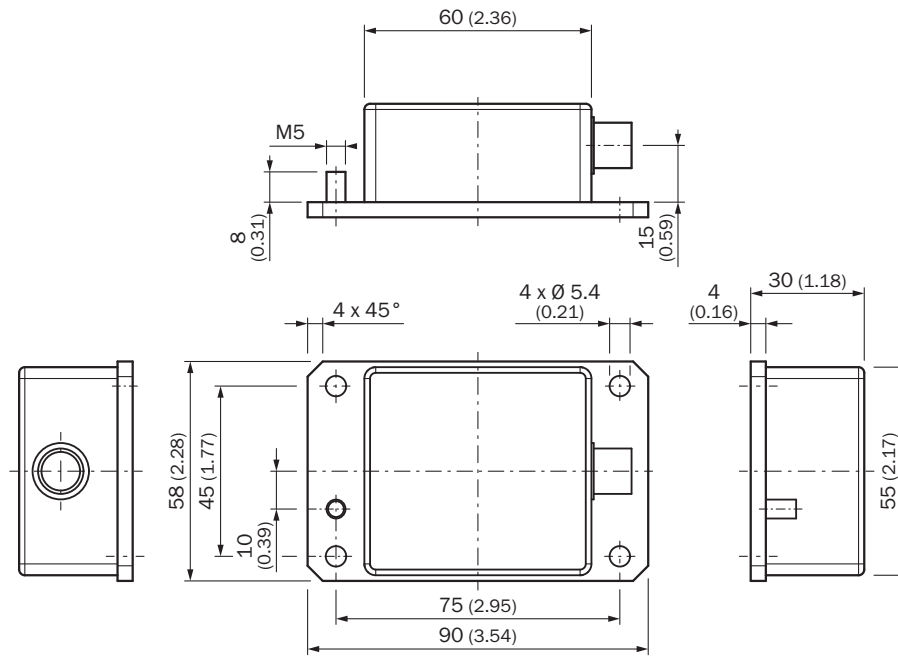



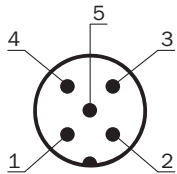





### PIN assignment



PIN	Signal	
<b>Male connector M12, 5-pin</b>		
1	CAN Shield	Shielding
2	VDC	Supply voltage
3	GND/CAN GND	0V (GND)
4	CAN high	CAN signal
5	CAN low	CAN signal

Recommended accessories

Other models and accessories → [www.sick.com/TMS\\_TMM88](http://www.sick.com/TMS_TMM88)

	Brief description	Type	Part no.
Programming and configuration tools			
	Hand-held programming device for the programmable SICK AHS/AHM36 CANopen encoders, TMS/TMM61 CANopen inclination sensors, TMS/TMM88 CANopen, TMS/TMM88 Analog, and wire draw encoders with AHS/AHM36 CANopen. Compact dimensions, low weight, and intuitive operation.	PGT-12-Pro	1076313
Others			
	<ul style="list-style-type: none"> <li>• <b>Connection type head A:</b> Male connector, M12, 5-pin, straight, A-coded</li> <li>• <b>Signal type:</b> CANopen, DeviceNet™</li> <li>• <b>Description:</b> CANopen, DeviceNet™, shielded, Head A: male connector, M12, 5-pin, straight, A coded, shielded, for cable diameter 4 mm ... 8 mm Head B: -</li> <li>• <b>Connection systems:</b> Screw-type terminals</li> <li>• <b>Permitted cross-section:</b> ≤ 0.75 mm²</li> </ul>	STE-1205-GA	6027533
	<ul style="list-style-type: none"> <li>• <b>Connection type head A:</b> Female connector, M12, 5-pin, straight, X-coded</li> <li>• <b>Signal type:</b> CANopen, DeviceNet™</li> <li>• <b>Description:</b> CANopen, DeviceNet™, shielded, Head A: female connector, M12, 5-pin, straight, shielded, for cable diameter 4.5 mm ... 7 mm Head B: -</li> <li>• <b>Connection systems:</b> Screw-type terminals</li> <li>• <b>Permitted cross-section:</b> ≤ 0.75 mm²</li> </ul>	DOS-1205-GA	6027534
	<ul style="list-style-type: none"> <li>• <b>Connection type head A:</b> Female connector, M12, 5-pin, straight, A-coded</li> <li>• <b>Connection type head B:</b> Flying leads</li> <li>• <b>Signal type:</b> Fieldbus, CANopen, DeviceNet™</li> <li>• <b>Cable:</b> 2 m, 4-wire, PUR, halogen-free</li> <li>• <b>Description:</b> Fieldbus, CANopen, DeviceNet™, shielded</li> <li>• <b>Application:</b> Drag chain operation, Zones with oils and lubricants</li> </ul>	YF2A15-020C1BXLEAX	2106283
	<ul style="list-style-type: none"> <li>• <b>Connection type head A:</b> Female connector, M12, 5-pin, straight, A-coded</li> <li>• <b>Connection type head B:</b> Flying leads</li> <li>• <b>Signal type:</b> Fieldbus, CANopen, DeviceNet™</li> <li>• <b>Cable:</b> 5 m, 4-wire, PUR, halogen-free</li> <li>• <b>Description:</b> Fieldbus, CANopen, DeviceNet™, shielded</li> <li>• <b>Application:</b> Drag chain operation, Zones with oils and lubricants</li> </ul>	YF2A15-050C1BXLEAX	2106284
	<ul style="list-style-type: none"> <li>• <b>Connection type head A:</b> Female connector, M12, 5-pin, straight, A-coded</li> <li>• <b>Connection type head B:</b> Flying leads</li> <li>• <b>Signal type:</b> Fieldbus, CANopen, DeviceNet™</li> <li>• <b>Cable:</b> 10 m, 4-wire, PUR, halogen-free</li> <li>• <b>Description:</b> Fieldbus, CANopen, DeviceNet™, shielded</li> <li>• <b>Application:</b> Drag chain operation, Zones with oils and lubricants</li> </ul>	YF2A15-100C1BXLEAX	2106286
	<ul style="list-style-type: none"> <li>• <b>Connection type head A:</b> Female connector, M12, 5-pin, straight, A-coded</li> <li>• <b>Connection type head B:</b> Male connector, M12, 5-pin, straight, A-coded</li> <li>• <b>Signal type:</b> Fieldbus, CANopen, DeviceNet™</li> <li>• <b>Cable:</b> 2 m, 4-wire, PUR, halogen-free</li> <li>• <b>Description:</b> Fieldbus, CANopen, DeviceNet™, shielded</li> <li>• <b>Application:</b> Drag chain operation, Zones with oils and lubricants</li> </ul>	YF2A15-020C1BM2A15	2106279
	<ul style="list-style-type: none"> <li>• <b>Connection type head A:</b> Female connector, M12, 5-pin, straight, A-coded</li> <li>• <b>Connection type head B:</b> Male connector, M12, 5-pin, straight, A-coded</li> <li>• <b>Signal type:</b> Fieldbus, CANopen, DeviceNet™</li> <li>• <b>Cable:</b> 5 m, 4-wire, PUR, halogen-free</li> <li>• <b>Description:</b> Fieldbus, CANopen, DeviceNet™, shielded</li> <li>• <b>Application:</b> Drag chain operation, Zones with oils and lubricants</li> </ul>	YF2A15-050C1BM2A15	2106281
	<ul style="list-style-type: none"> <li>• <b>Connection type head A:</b> Female connector, M12, 5-pin, straight, A-coded</li> <li>• <b>Connection type head B:</b> Male connector, M12, 5-pin, straight, A-coded</li> <li>• <b>Signal type:</b> Fieldbus, CANopen, DeviceNet™</li> <li>• <b>Cable:</b> 10 m, 4-wire, PUR, halogen-free</li> <li>• <b>Description:</b> Fieldbus, CANopen, DeviceNet™, shielded</li> <li>• <b>Application:</b> Drag chain operation, Zones with oils and lubricants</li> </ul>	YF2A15-100C1BM2A15	2106282

## SICK AT A GLANCE

SICK is one of the leading manufacturers of intelligent sensors and sensor solutions for industrial applications. A unique range of products and services creates the perfect basis for controlling processes securely and efficiently, protecting individuals from accidents and preventing damage to the environment.

We have extensive experience in a wide range of industries and understand their processes and requirements. With intelligent sensors, we can deliver exactly what our customers need. In application centers in Europe, Asia and North America, system solutions are tested and optimized in accordance with customer specifications. All this makes us a reliable supplier and development partner.

Comprehensive services complete our offering: SICK LifeTime Services provide support throughout the machine life cycle and ensure safety and productivity.

For us, that is “Sensor Intelligence.”

## WORLDWIDE PRESENCE:

Contacts and other locations –[www.sick.com](http://www.sick.com)