

Oval Lamp EALP03OLA series



Features

- High luminous intensity output.
- Low power consumption.
- The product itself will remain within RoHS compliant version.
- Compliance with EU REACH.
- Compliance Halogen free. (Br <900 ppm, Cl<900 ppm, Br+Cl <1500 ppm)

Description

- This precision optical performance oval LED is specifically designed for passenger information signs.

Applications

- Color Graphic Signs.
- Message boards.
- Variable message signs (VMS).
- Commercial outdoor advertising.

Device Selection Guide

Part No.	Tapping	Chip Material	Emitted Color	Lens Color
EALP03OLARA4	No	AlGaInP	Brilliant Red	Red Diffused
EALP03OLARA5	Yes			
EALP03OLAGA3	No	InGaN	Brilliant Green	Green Diffused
EALP03OLAGA4	Yes			
EALP03OLABA3	No	InGaN	Blue	Blue Diffused
EALP03OLABA4	Yes			

Absolute Maximum Ratings (Ta=25°C)

Parameter	Symbol	Rating	Unit
Forward Current	I_F	20	mA
Reverse Voltage	V_R	5	V
Operating Temperature	T_{opr}	-40 ~ +85	°C
Storage Temperature	T_{stg}	-40 ~ +100	°C
Reverse Current	I_R	1	μA
Soldering Temperature	T_{sol}	260 °C for 5 sec.	

Electro-Optical Characteristics (Ta=25°C)

Parameter	Symbol		Min.	Typ.	Max.	Unit	Condition
Luminous Intensity	I _v	R	717	--	1238	mcd	R I _F =15mA G I _F =15mA B I _F =10mA
		G	2520	--	4354		
		B	377	--	653		
Viewing Angle	2θ _{1/2}	R	--	X:108Y:62	--	deg	
		G	--	X:108Y:60	--		
		B	--	X:108Y:60	--		
Dominant Wavelength	λ _d	R	619	--	627	nm	
		G	518	--	527		
		B	468	--	474		
Forward Voltage	V _F	R	1.8	--	2.3	V	
		G	2.8	--	3.3		
		B	2.8	--	3.3		
Reverse Current	I _R		--	--	5	μA	V _R =5V

Note:
Tolerance of Forward Voltage: ±0.1V

Bin Range of Luminous Intensity

R		G		B		Unit	Condition
717-860	826-991	2520-3024	3024-3628	377-453	453-543	mcd	R I _F =15mA G I _F =15mA B I _F =10mA
860-1032	991-1189	3628-4354	/	543-653	/		
1032-1238	/	/	/	/	/		

Note:
Tolerance of Luminous Intensity: ±10%

Bin Range of Dominant Wavelength

R	G			B	Unit	Condition
619-623	518-521	521-524	524-527	468-471	nm	R I _F =15mA G I _F =15mA B I _F =10mA
623-627	517-520	520-523	523-526	471-474		

Note:
Tolerance of Dominant Wavelength: ±1nm

Typical Electro-Optical Characteristics Curves

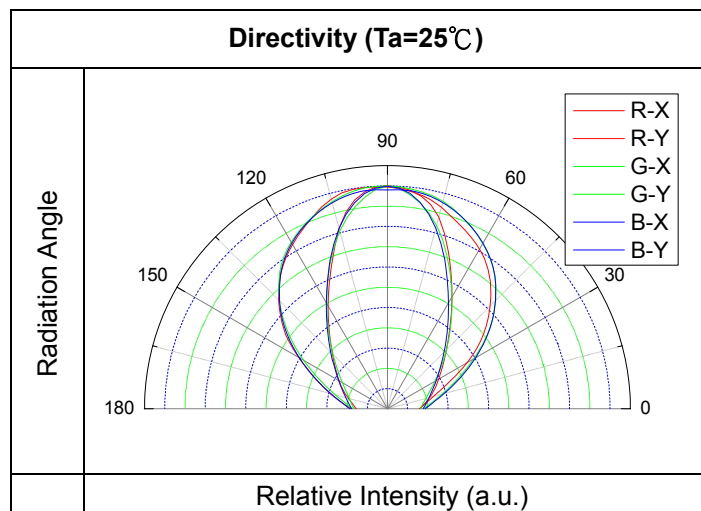
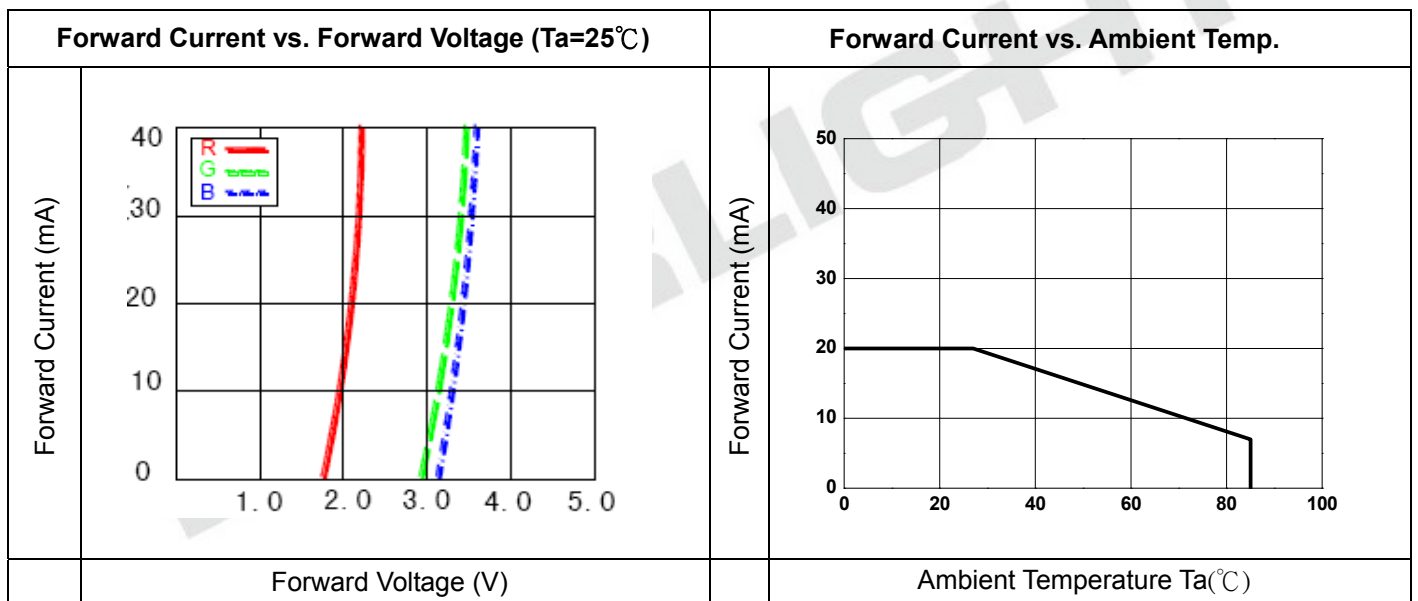
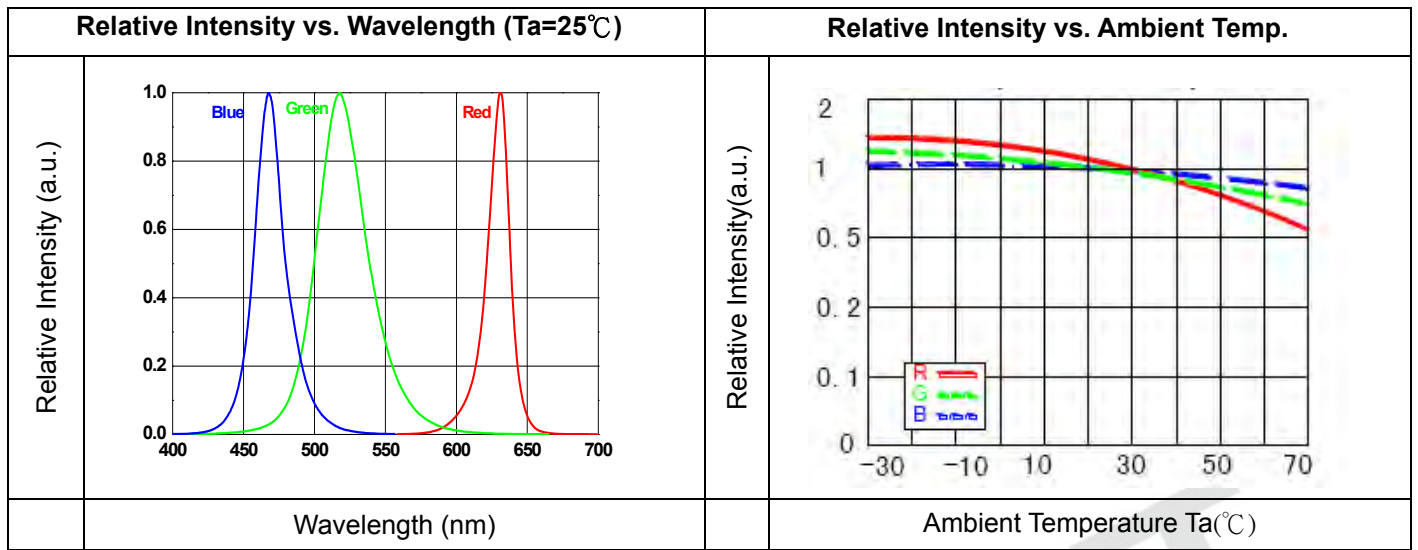

Package Dimension

R

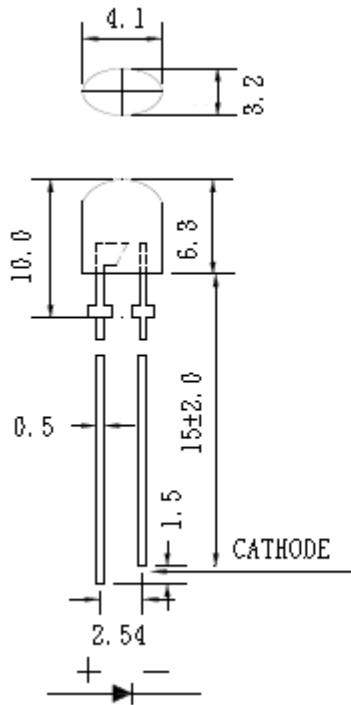

G/B

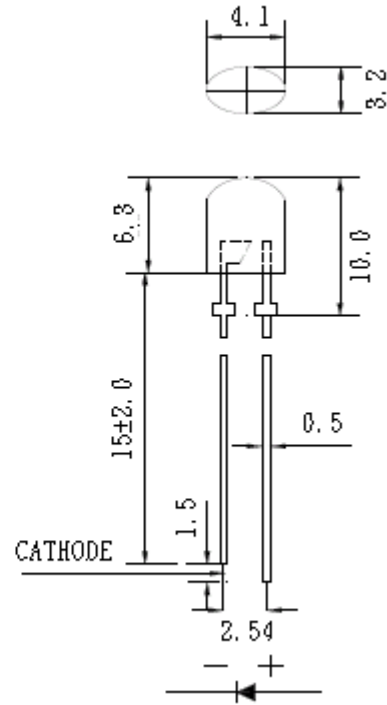

Note:
*Other dimensions are in millimeters, tolerance is 0.2mm except being specified.

Moisture Resistant Packing Materials

Label Explanation

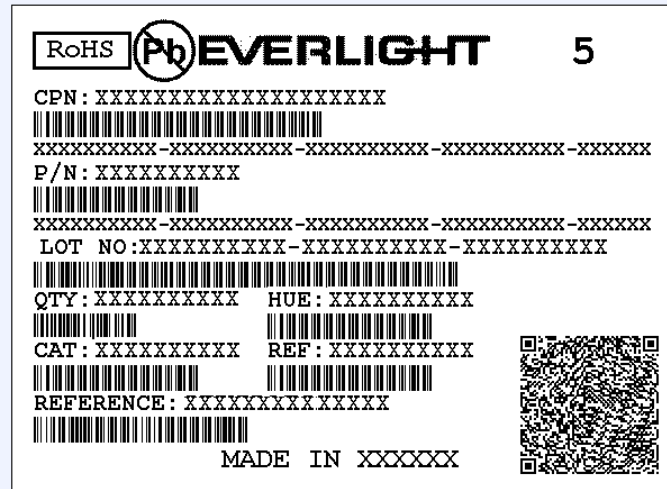

- CPN: Customer's Production Number
- P/N : Production Number
- QTY: Packing Quantity
- CAT: Ranks of Luminous Intensity
- HUE: Color Rank
- REF: Forward Voltage
- LOT No: Lot Number

Bulk Pack Packaging Type:

■ Anti-electrostatic bag

■ Inner Carton

■ Outside Carton

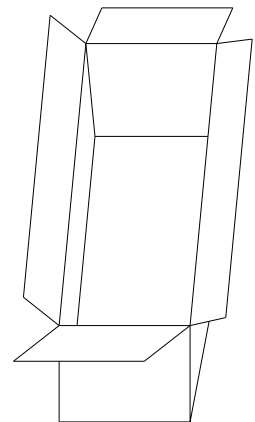
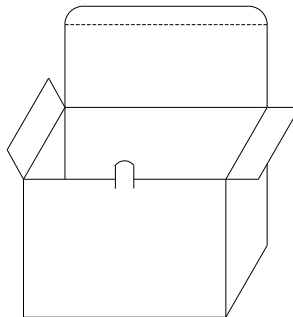
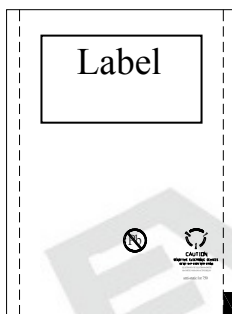

■ Packing Quantity

1. Min 200pcs to Max 1000 PCS/1 Bag, 5 Bags/1 Inner Carton.
2. 10 Inner Cartons/1 Outside Carton

Carrier Tape Dimensions:

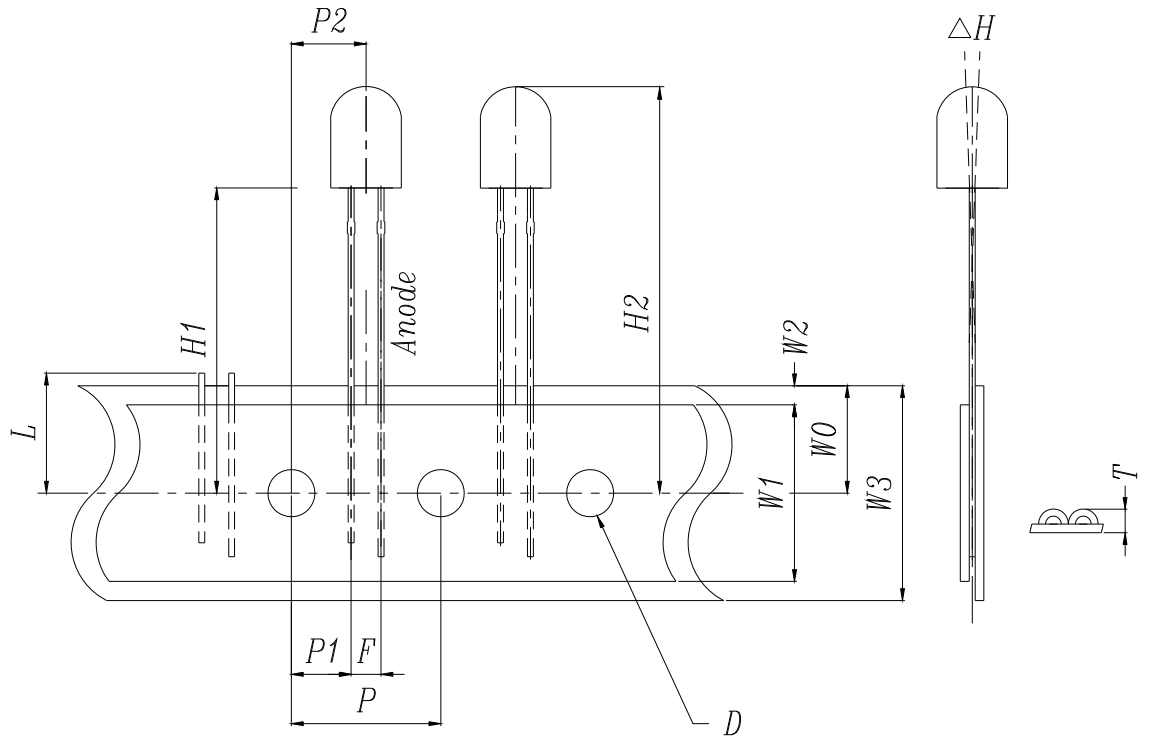

Taping Sizes

Symbol Items	Symbol	Specifications		
		Avg.		Tolerance
		mm	Inch	(mm)
Tape Feed Hole Diameter	D	4.00	0.157	±0.2
Component Lead Pitch	F	2.54	0.100	±0.3
Front-to-Read Deflection	ΔH	2.0	0.078	Max
Feed Hole to Button of Component	H1	18.5	0.729	±1.0
Feed Hole to Overall Component Height	H2	24.8	0.977	±1.0
Lead Length after Component Removal	L	11.00	0.433	Max
Feed Hole Pitch	P	12.70	0.500	±0.3
Lead Location	P1	5.10	0.200	±0.7
Center of Component Location	P2	6.35	0.250	±1.2
Overall Taped Package Thickness	T	1.42	0.056	Max
Feed Hole Location	W0	9.00	0.354	±0.5
Adhesive Tape Width	W1	13.00	0.512	±0.5
Adhesive Tape Position	W2	4.00	0.157	Max
Tape Width	W3	18.00	0.709	±0.75

Moisture Resistant Packing Process

■ Inner Carton

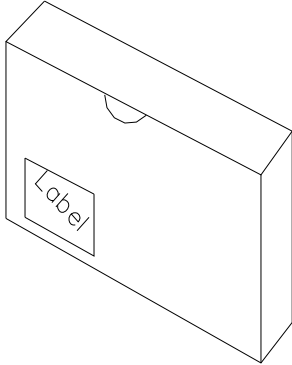

■ Packing Quantity

1. 2500 PCS/1 Inner Carton
2. 10 Inner Cartons/1 Outside Carton

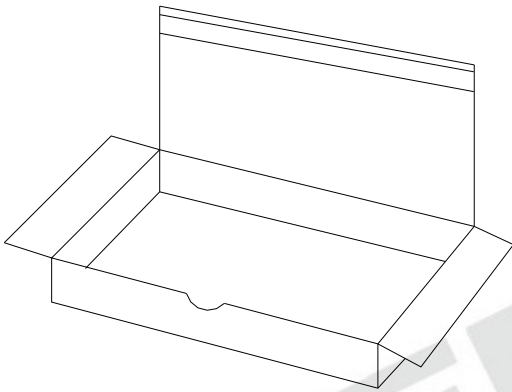

■ Outside Carton

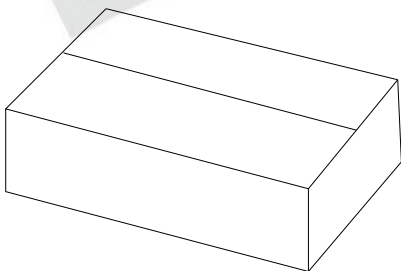

Notes

1. Lead Forming

- During lead formation, the leads should be bent at a point at least 3mm from the base of the epoxy bulb.
- Lead forming should be done before soldering.
- Avoid stressing the LED package during leads forming. The stress to the base may damage the LED's characteristics or it may break the LEDs.
- Cut the LED leadframes at room temperature. Cutting the leadframes at high temperatures may cause failure of the LEDs.
- When mounting the LEDs onto a PCB, the PCB holes must be aligned exactly with the lead position of the LED. If the LEDs are mounted with stress at the leads, it causes deterioration of the epoxy resin and this will degrade the LEDs.

2. Storage

- The LEDs should be stored at 30°C or less and 70%RH or less after being shipped from Everlight and the storage life limits are 3 months. If the LEDs are stored for 3 months or more, they can be stored for a year in a sealed container with a nitrogen atmosphere and moisture absorbent material.
- Please avoid rapid transitions in ambient temperature, especially, in high humidity environments where condensation can occur.
- Once the package is opened, the products should be used within 24 hrs. Otherwise, they should be kept in a damp proof box with desiccating regent. We suggest our customers to use our products within 1 months (from production date) .

3. Soldering

- Careful attention should be paid during soldering. When soldering, leave more then 3mm from solder joint to epoxy bulb, and soldering beyond the base of the tie bar is recommended.
- Recommended soldering conditions:

Hand Soldering		DIP Soldering	
Temp. at tip of iron	300°C Max. (30W Max.)	Preheat temp.	100 °C Max. (60 sec Max.)
Soldering time	3 sec Max.	Bath temp. & time	260 Max., 5 sec Max
Distance	3mm Min.(From solder joint to epoxy bulb)	Distance	3mm Min. (From solder joint to epoxy bulb)

- Recommended soldering profile

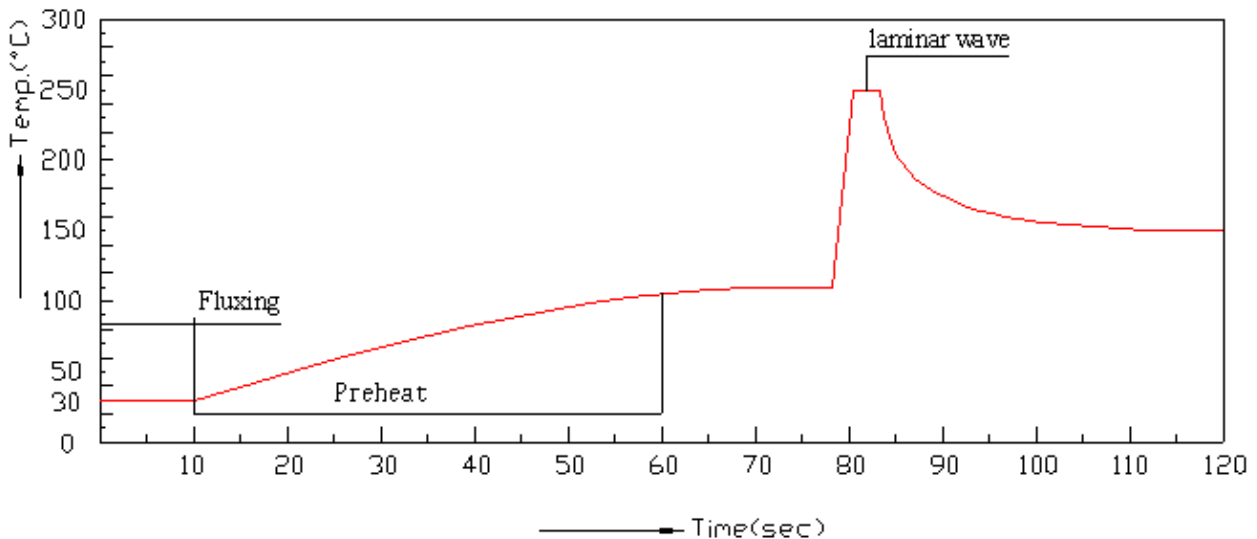

- Avoiding applying any stress to the lead frame while the LEDs are at high temperature particularly when soldering.
 - Dip and hand soldering should not be done more than one time
 - After soldering the LEDs, the epoxy bulb should be protected from mechanical shock or vibration until the LEDs return to room temperature.
 - A rapid-rate process is not recommended for cooling the LEDs down from the peak temperature.
 - Although the recommended soldering conditions are specified in the above table, dip or handsoldering at the lowest possible temperature is desirable for the LEDs.

 - Wave soldering parameter must be set and maintain according to recommended temperature and dwell time in the solder wave.
4. Cleaning
- When necessary, cleaning should occur only with isopropyl alcohol at room temperature for a duration of no more than one minute. Dry at room temperature before use.
 - Do not clean the LEDs by the ultrasonic. When it is absolutely necessary, the influence of ultrasonic cleaning on the LEDs depends on factors such as ultrasonic power and the assembled condition. Ultrasonic cleaning shall be pre-qualified to ensure this will not cause damage to the LED
5. Heat Management
- Heat management of LEDs must be taken into consideration during the design stage of LED application. The current should be de-rated appropriately by referring to the de-rating curve found in each product specification.
 - The temperature surrounding the LED in the application should be controlled. Please refer to the data sheet de-rating curve.
6. ESD (Electrostatic Discharge)
- The products are sensitive to static electricity or surge voltage. ESD can damage a die and its reliability. When handling the products, the following measures against electrostatic discharge are strongly recommended:
 - Eliminating the charge
 - Grounded wrist strap, ESD footwear, clothes, and floors
 - Grounded workstation equipment and tools
 - ESD table/shelf mat made of conductive materials
 - Proper grounding is required for all devices, equipment, and machinery used in product assembly. Surge protection should be considered when designing of commercial products.
 - If tools or equipment contain insulating materials such as glass or plastic, the following measures against electrostatic discharge are strongly recommended:
 - Dissipating static charge with conductive materials
 - Preventing charge generation with moisture
 - Neutralizing the charge with ionizers.

7. Directions for use

- The LEDs should be operated with forward bias. The driving circuit must be designed so that the LEDs are not subjected to forward or reverse voltage while it is off. If reverse voltage is continuously applied to the LEDs, it may cause migration resulting in LED damage.

8. Other

- Above specification may be changed without notice. EVERLIGHT will reserve authority on material change for above specification.
- When using this product, please observe the absolute maximum ratings and the instructions for using outlined in these specification sheets. EVERLIGHT assumes no responsibility for any damage resulting from use of the product which does not comply with the absolute maximum ratings and the instructions included in these specification sheets.
- These specification sheets include materials protected under copyright of EVERLIGHT corporation. Please do

DISCLAIMER

1. EVERLIGHT reserves the right(s) on the adjustment of product material mix for the specification.
2. The product meets EVERLIGHT published specification for a period of twelve (12) months from date of shipment.
3. The graphs shown in this datasheet are representing typical data only and do not show guaranteed values.
4. When using this product, please observe the absolute maximum ratings and the instructions for using outlined in these specification sheets. EVERLIGHT assumes no responsibility for any damage resulting from the use of the product which does not comply with the absolute maximum ratings and the instructions included in these specification sheets.
5. These specification sheets include materials protected under copyright of EVERLIGHT. Reproduction in any form is prohibited without obtaining EVERLIGHT's prior consent.
6. This product is not intended to be used for military, aircraft, automotive, medical, life sustaining or life saving applications or any other application which can result in human injury or death. Please contact authorized Everlight sales agent for special application request.