

EPC2302 – Enhancement Mode Power Transistor

V_{DS} , 100 V

$R_{DS(on)}$, 1.8 mΩ max

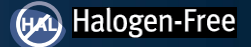

General Description

The EPC2302 is a 1.8 mΩ max $R_{DS(on)}$, 100 V eGaN® power transistor in a low inductance 3 x 5 mm QFN package with exposed top for excellent thermal management. It is tailored to high frequency DC-DC applications to/from 40 V–60 V and 48 V BLDC motor drives.

The thermal resistance to case top is ~0.2 °C/W, resulting in excellent thermal behavior and easy cooling. The device features an enhanced PQFN “Thermal-Max” package. The exposed top enhances top-side thermal management and the side-wettable flanks guarantee that the complete side-pad surface is wetted with solder during the reflow soldering process, which protects the copper and allows soldering to occur on this external flank area for easy optical inspection.

Compared to a Si MOSFET, the footprint of 15 mm² is less than half of the size of the best-in-class Si MOSFET with similar $R_{DS(on)}$ and voltage rating, Q_G and Q_{GD} are significantly smaller and Q_{RR} is 0. This results in lower switching losses and lower gate driver losses. Moreover, EPC2302 is very fast and can operate with deadtime less than 10 ns for higher efficiency and $Q_{RR} = 0$ is a big advantage for reliability and EMI. In summary, EPC2302 allows the highest power density due to enhanced efficiency, smaller size, and higher switching frequency for smaller inductor and fewer capacitors.

The EPC2302 enables designers to improve efficiency and save space. The excellent thermal behavior enables easier and lower cost cooling. The ultra-low capacitance and zero reverse recovery of the eGaN® FET enables efficient operation in many topologies. Performance is further enhanced due to the small, low inductance footprint.

Application notes:

- Easy-to-use and reliable gate, Gate Drive ON = 5 V typical, OFF = 0 V (negative voltage not needed)
- Top of FET is electrically connected to source



Maximum Ratings

PARAMETER		VALUE	UNIT
V_{DS}	Drain-to-Source Voltage (Continuous)	100	V
$V_{DS(tr)}$	Drain-to-Source Voltage (Repetitive Transient) ⁽¹⁾	120	
I_D	Continuous ($T_A = 25^\circ\text{C}$)	101	A
	Pulsed (25°C , $T_{PULSE} = 300 \mu\text{s}$)	408	
V_{GS}	Gate-to-Source Voltage	6	V
	Gate-to-Source Voltage	-4	
T_J	Operating Temperature	-40 to 150	°C
T_{STG}	Storage Temperature	-55 to 175	

⁽¹⁾ Pulsed repetitively, duty cycle factor (DC_{Factor}) ≤ 1%;
See Figure 13 and **Reliability Report Phase 16**, Section 3.2.6

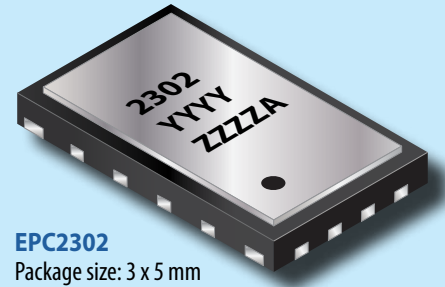

EPC2302

Package size: 3 x 5 mm

Features

- 100 V
- 1.4 mΩ typical, 1.8 mΩ max $R_{DS(on)}$
- 3 x 5 mm QFN package
- Exposed top for top-side thermal management
- Moisture rating MSL2
- Enhanced Thermal-Max package

Applications

- AC-DC chargers, SMPS, adaptors, power supplies
- High Frequency DC-DC Conversion up to 80 V input (Buck, Boost, Buck-Boost and LLC)
- 24 V–60 V Motor Drives
- High Power Density DC-DC modules from 40 V–60 V to 5 V–12 V
- Synchronous Rectification
- Solar MPPT

Benefits

- Ultra High Efficiency
- No Reverse Recovery
- Ultra Low Q_G
- Small Footprint
- Excellent Thermal

Scan QR code or click link below for more information including reliability reports, device models, demo boards!



<https://l.lead.me/EPC2302>

Thermal Characteristics

PARAMETER		TYP	UNIT
$R_{\theta JC}$	Thermal Resistance, Junction-to-Case (Case TOP)	0.2	°C/W
$R_{\theta JB}$	Thermal Resistance, Junction-to-Board (Case BOTTOM)	1.5	
$R_{\theta JA_JEDEC}$	Thermal Resistance, Junction-to-Ambient (using JEDEC 51-2 PCB)	45	
$R_{\theta JA_EVB}$	Thermal Resistance, Junction-to-Ambient (using EPC90142 EVB)	21	

Static Characteristics ($T_J = 25^\circ\text{C}$ unless otherwise stated)

PARAMETER		TEST CONDITIONS	MIN	TYP	MAX	UNIT
BV_{DSS}	Drain-to-Source Voltage	$V_{GS} = 0\text{ V}, I_D = 0.15\text{ mA}$	100			V
I_{DSS}	Drain-Source Leakage	$V_{DS} = 80\text{ V}, V_{GS} = 0\text{ V}$		1	100	μA
I_{GSS}	Gate-to-Source Forward Leakage	$V_{GS} = 5\text{ V}$		0.01	4	mA
	Gate-to-Source Forward Leakage [#]	$V_{GS} = 5\text{ V}, T_J = 125^\circ\text{C}$		0.4	9	
	Gate-to-Source Reverse Leakage	$V_{GS} = -4\text{ V}$		0.01	0.2	
$V_{GS(TH)}$	Gate Threshold Voltage	$V_{DS} = V_{GS}, I_D = 14\text{ mA}$	0.8	1.3	2.5	V
$R_{DS(on)}$	Drain-Source On Resistance	$V_{GS} = 5\text{ V}, I_D = 50\text{ A}$		1.4	1.8	m Ω
V_{SD}	Source-to-Drain Forward Voltage	$I_S = 0.5\text{ A}, V_{GS} = 0\text{ V}$		1.5		V

Defined by design. Not subject to production test.

Dynamic Characteristics[#] ($T_J = 25^\circ\text{C}$ unless otherwise stated)

PARAMETER		TEST CONDITIONS	MIN	TYP	MAX	UNIT
C_{ISS}	Input Capacitance	$V_{DS} = 50\text{ V}, V_{GS} = 0\text{ V}$		3200	4800	pF
C_{RSS}	Reverse Transfer Capacitance			7		
C_{OSS}	Output Capacitance			1000	1200	
$C_{OSS(ER)}$	Effective Output Capacitance, Energy Related (Note 1)	$V_{DS} = 0\text{ to }50\text{ V}, V_{GS} = 0\text{ V}$		1300		
$C_{OSS(TR)}$	Effective Output Capacitance, Time Related (Note 2)			1700		
R_G	Gate Resistance			0.5		Ω
Q_G	Total Gate Charge	$V_{DS} = 50\text{ V}, V_{GS} = 5\text{ V}, I_D = 50\text{ A}$		23	29	nC
Q_{GS}	Gate-to-Source Charge	$V_{DS} = 50\text{ V}, I_D = 50\text{ A}$		8.9		
Q_{GD}	Gate-to-Drain Charge			2.3		
$Q_{G(TH)}$	Gate Charge at Threshold			6.3		
Q_{OSS}	Output Charge	$V_{DS} = 50\text{ V}, V_{GS} = 0\text{ V}$		85	94	
Q_{RR}	Source-Drain Recovery Charge			0		

Defined by design. Not subject to production test.

Note 1: $C_{OSS(ER)}$ is a fixed capacitance that gives the same stored energy as C_{OSS} while V_{DS} is rising from 0 to 50% BV_{DSS} .

Note 2: $C_{OSS(TR)}$ is a fixed capacitance that gives the same charging time as C_{OSS} while V_{DS} is rising from 0 to 50% BV_{DSS} .

Figure 1: Typical Output Characteristics at 25°C

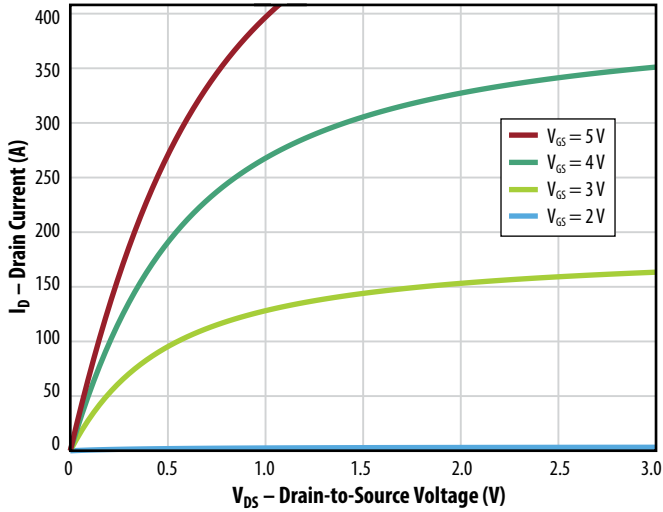

Figure 2: Typical Transfer Characteristics

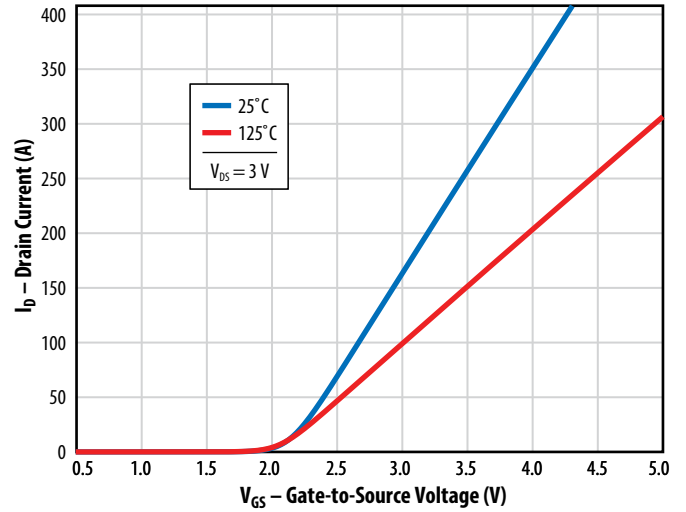

Figure 3: Typical $R_{DS(on)}$ vs. V_{GS} for Various Drain Currents

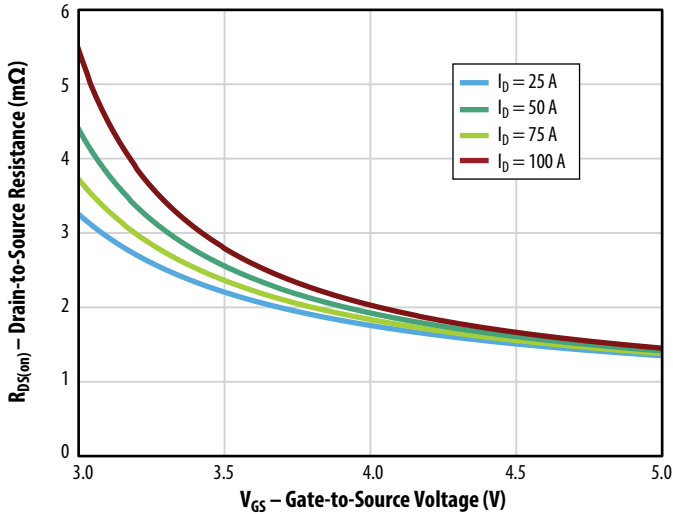

Figure 4: Typical $R_{DS(on)}$ vs. V_{GS} for Various Temperatures

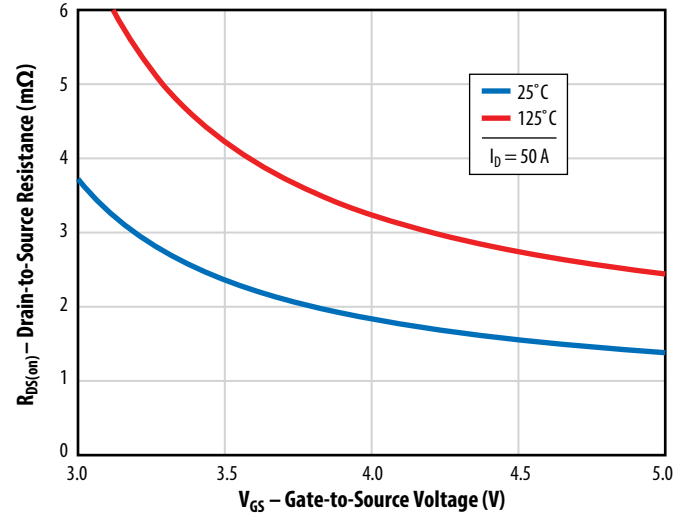

Figure 5a: Typical Capacitance (Linear Scale)

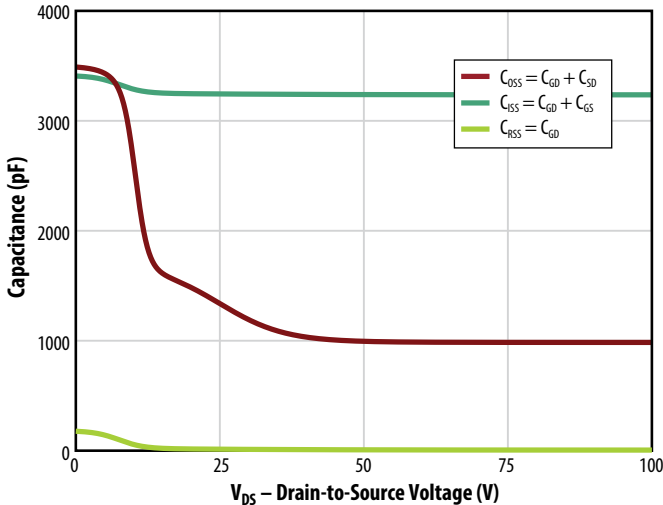

Figure 5b: Typical Capacitance (Log Scale)

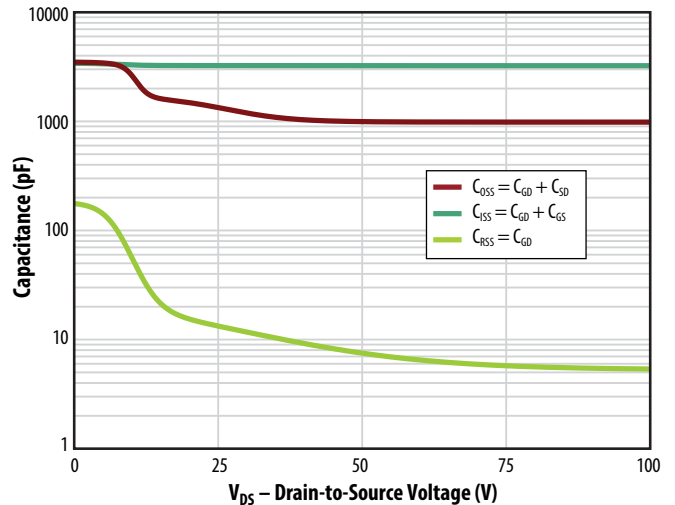

Figure 6: Typical Output Charge and C_{OSS} Stored Energy

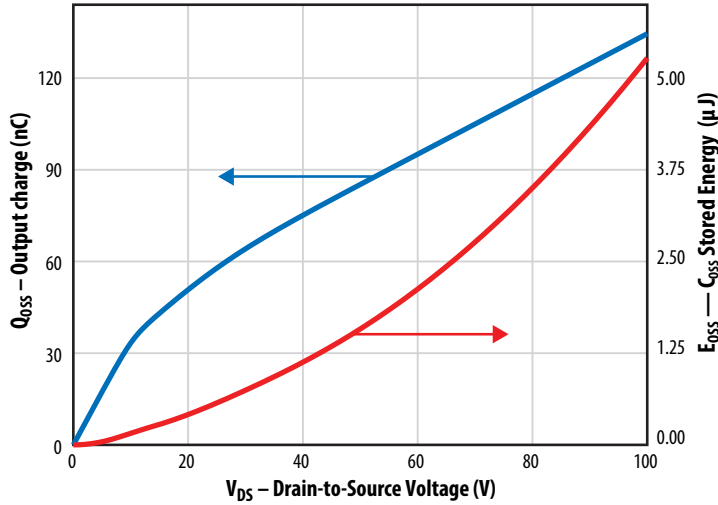

Figure 7: Typical Gate Charge

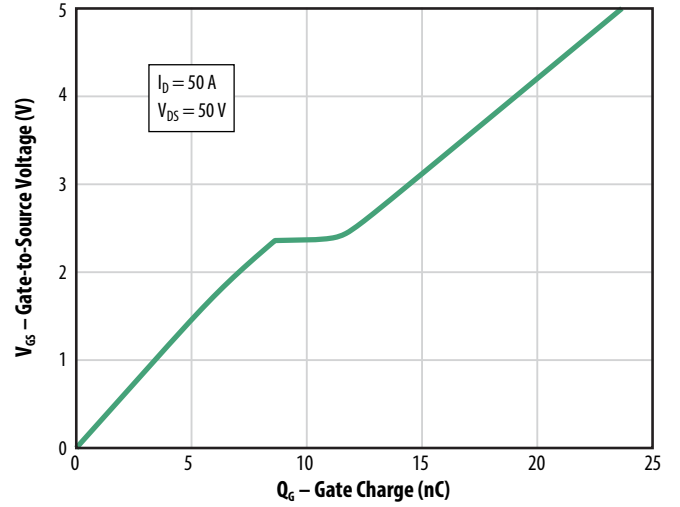

Figure 8: Typical Reverse Drain-Source Characteristics

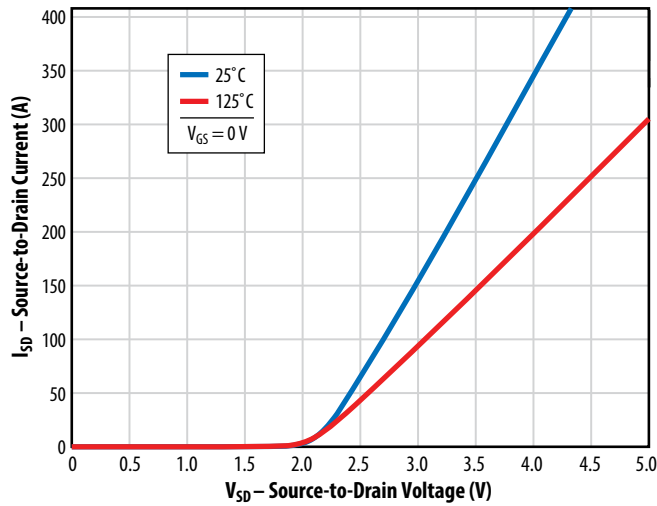

Figure 9: Typical Normalized On-State Resistance vs. Temp.

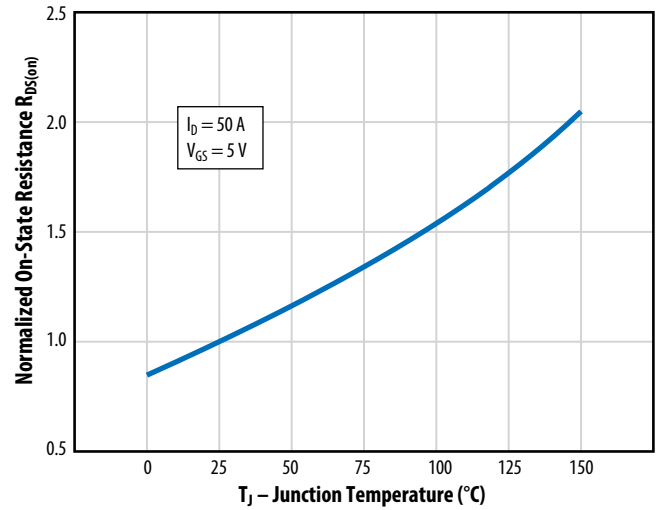

Figure 10: Typical Normalized Threshold Voltage vs. Temp.

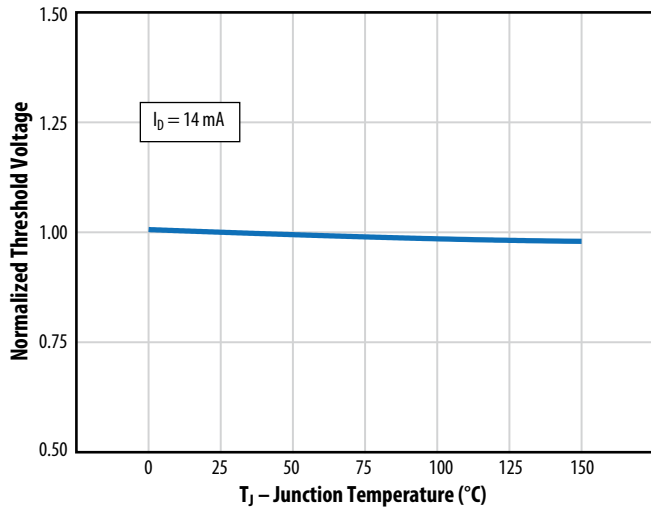

Figure 11: Safe Operating Area

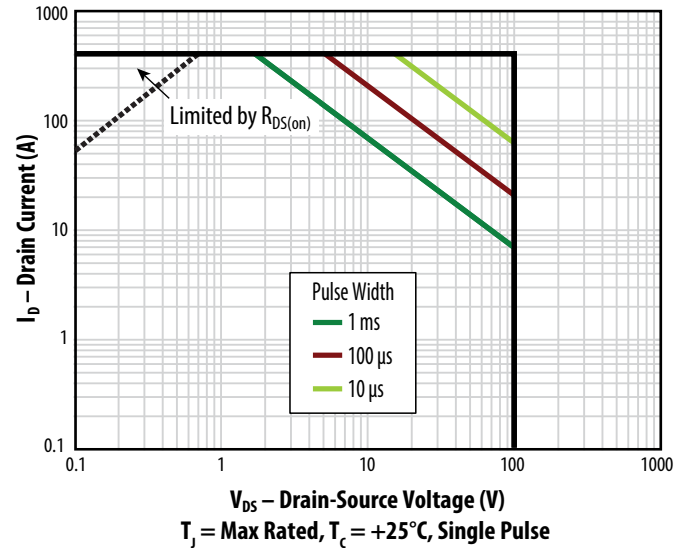

Figure 12: Transient Thermal Response Curves

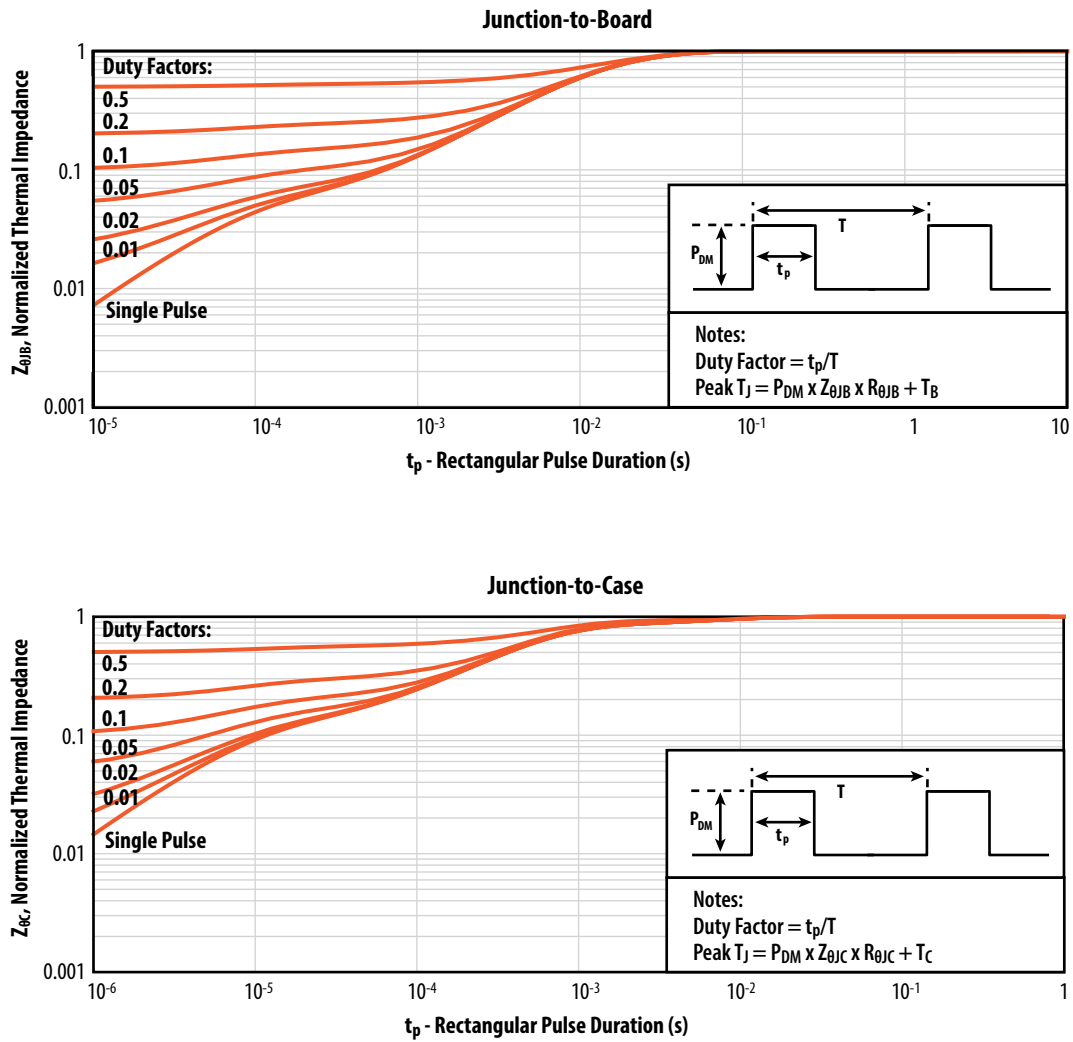
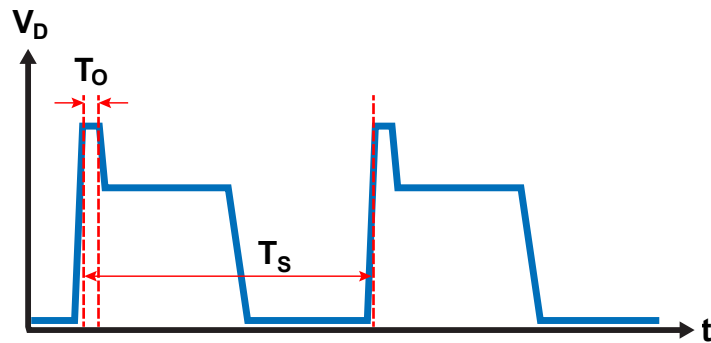

Figure 13: Duty Cycle Factor (DC_{Factor}) Illustration for Repetitive Overvoltage Specification



1% is the ratio between T_O (overvoltage duration) and T_S (one switching period).

LAYOUT CONSIDERATIONS

GaN transistors generally behave like power MOSFETs, but at much higher switching speeds and power densities, therefore layout considerations are very important, and care must be taken to minimize layout parasitic inductances. The recommended design utilizes the first inner layer as a power loop return path. This return path is located directly beneath the top layer’s power loop allowing for the smallest physical loop size. This method is also commonly referred to as flux cancellation. Variations of this concept can be implemented by placing the bus capacitors either next to the high side device, next to the low side device, or between the low and high side devices, but in all cases the loop is closed using the first inner layer right beneath the devices.

A similar concept is also used for the gate loop, with the return gate loop located directly under the turn ON and OFF gate resistors.

Furthermore, to minimize the common source inductance between power and gate loops, the power and gate loops are laid out perpendicular to each other, and a via next to the source pad closest to the gate pad is used as Kelvin connection for the gate driver return path.

The **EPC90133 – 100 V, 40 A Half-Bridge Development Board Featuring EPC2302** implements our recommended vertical inner layout.

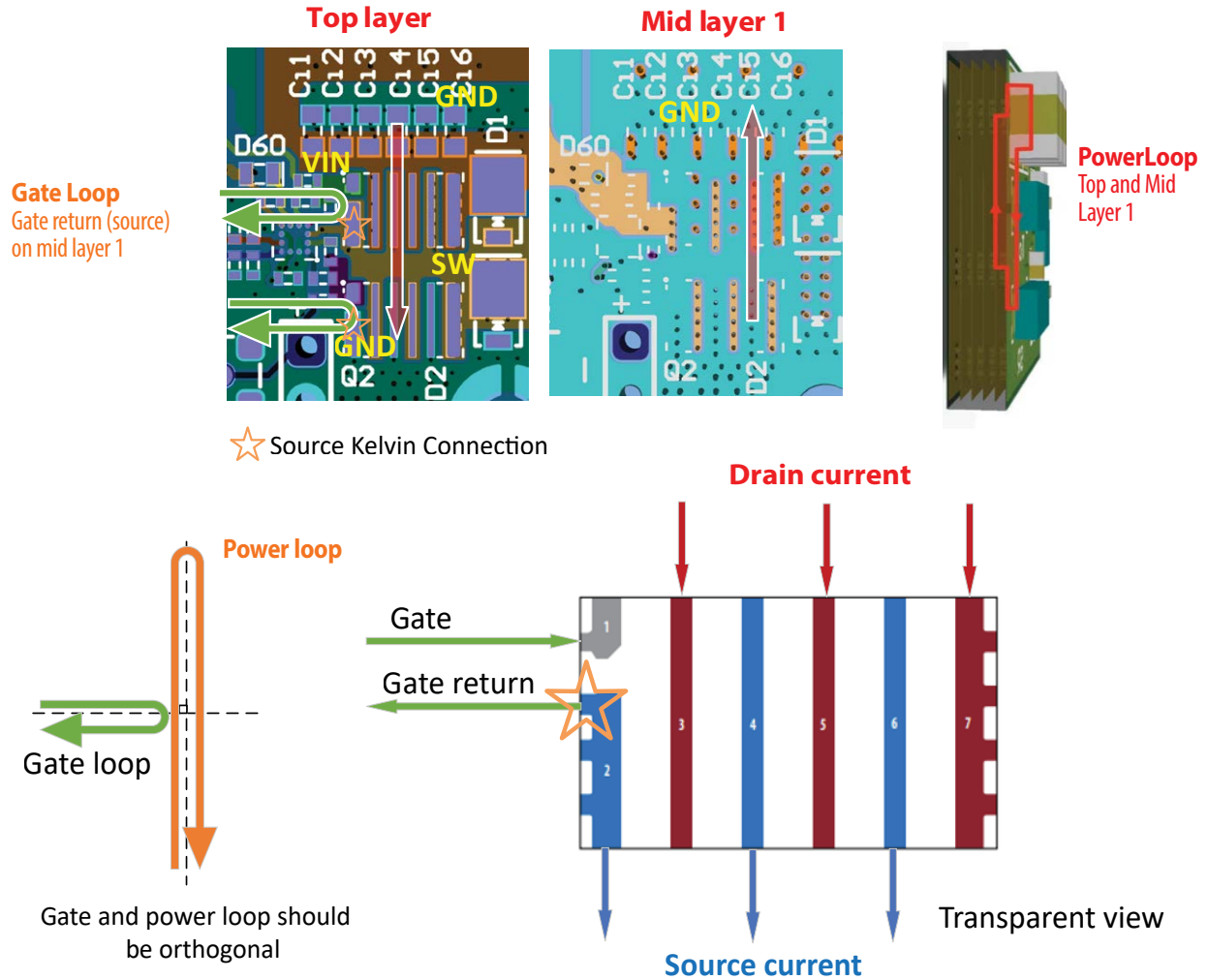

Figure 13: Inner Vertical Layout for Power and Gate Loops from EPC90133

Detailed recommendations on layout can be found on EPC’s website: [Optimizing PCB Layout with eGaN FETs.pdf](#)

TYPICAL THERMAL CONCEPT

The EPC2302 can take advantage of dual sided cooling to maximize its heat dissipation capabilities in high power density designs. **Note that the top of EPC FETs are connected to source potential, so for half-bridge topologies the Thermal Interface Material (TIM) needs to provide electrical isolation to the heatsink.**

Recommended best practice thermal solutions are covered in detail in [How2AppNote012 - How to Get More Power Out of an eGaN Converter.pdf](#).

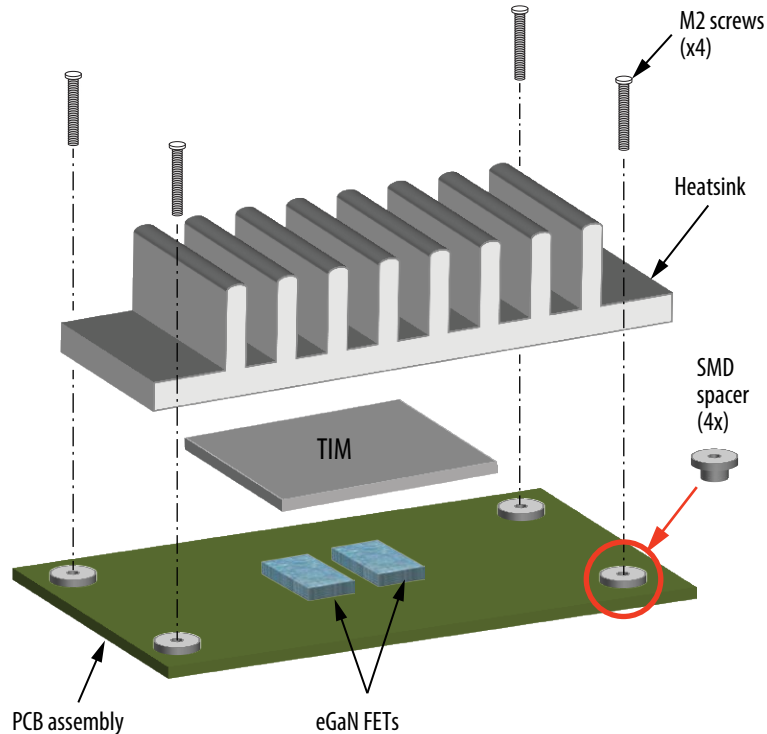

Figure 15: Exploded view of heatsink assembly using screws

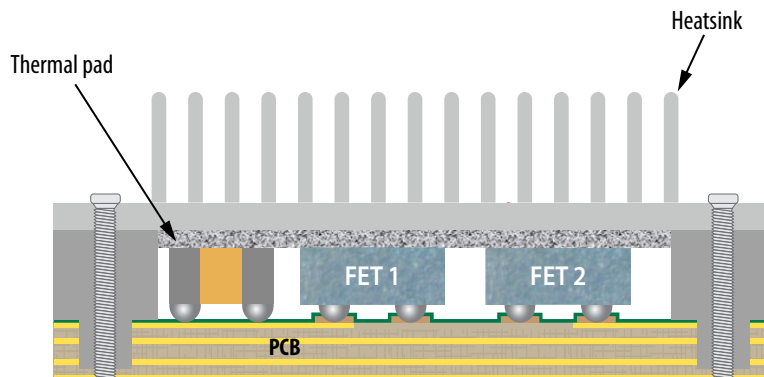
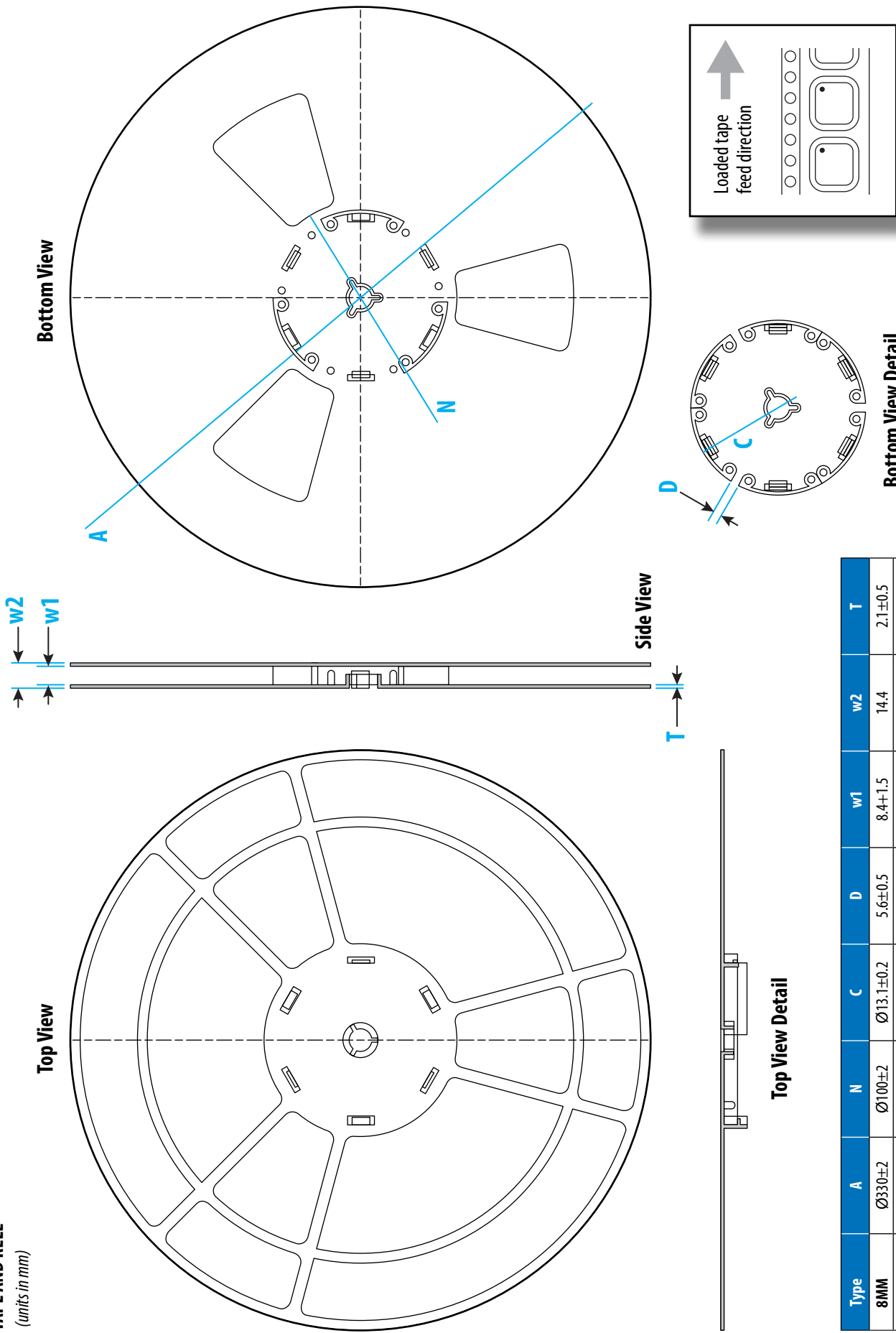

Figure 16: A cross-section image of dual sided thermal solution

Note: Connecting the heatsink to ground is recommended and can significantly improve radiated EMI

The thermal design can be optimized by using the [GaN FET Thermal Calculator](#) on EPC's website.

TAPE AND REEL
(units in mm)



Type	A	N	C	D	w1	w2	T
8MM	$\varnothing 330 \pm 2$	$\varnothing 100 \pm 2$	$\varnothing 13.1 \pm 0.2$	5.6 ± 0.5	8.4 ± 1.5	14.4	2.1 ± 0.5
12MM	$\varnothing 330 \pm 2$	$\varnothing 100 \pm 2$	$\varnothing 13.1 \pm 0.2$	5.6 ± 0.5	12.4 ± 1.5	18.4	2.1 ± 0.5
16MM	$\varnothing 330 \pm 2$	$\varnothing 100 \pm 2$	$\varnothing 13.1 \pm 0.2$	5.6 ± 0.5	16.4 ± 1.5	22.4	2.1 ± 0.5
24MM	$\varnothing 330 \pm 2$	$\varnothing 100 \pm 2$	$\varnothing 13.1 \pm 0.2$	5.6 ± 0.5	24.4 ± 1.5	30.4	2.1 ± 0.5

QFN Markings (label date code 2424 onward)

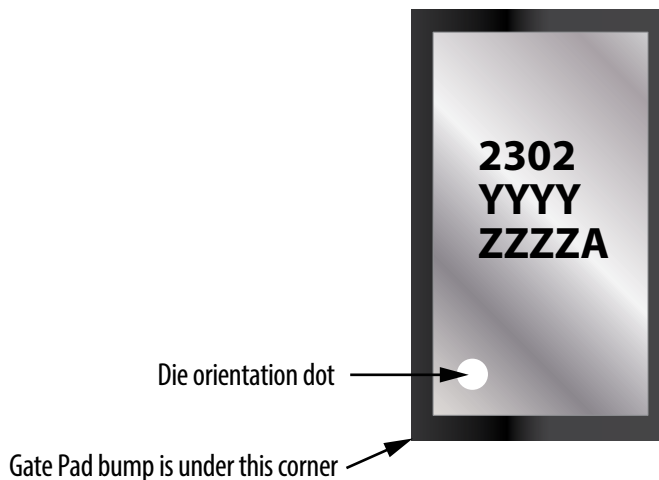

Part Number	Laser Markings		
	Part # Marking Line 1	Lot_Date Code Marking Line 2	Lot_Date Code Marking Line 3
EPC2302	2302	YYYY	ZZZA

Marking prior to label date code 2424

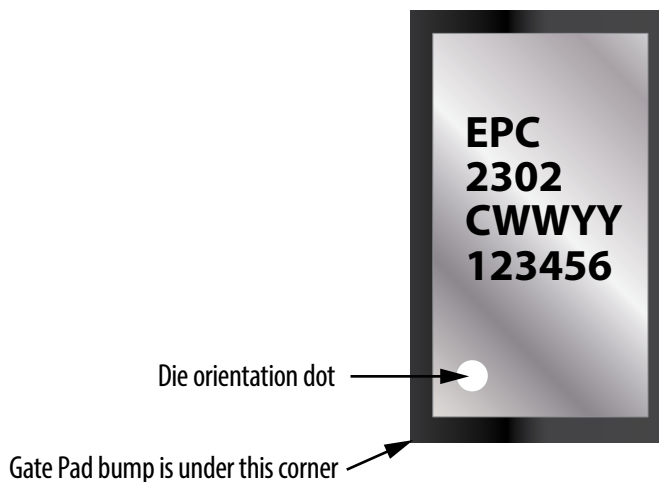

Part Number	Laser Markings			
	Company Name Marking Line 1	Part # Marking Line 2	Site_Date Code Marking Line 3	Lot_Code Marking Line 4
EPC2302	EPC	2302	CWWYY	123456

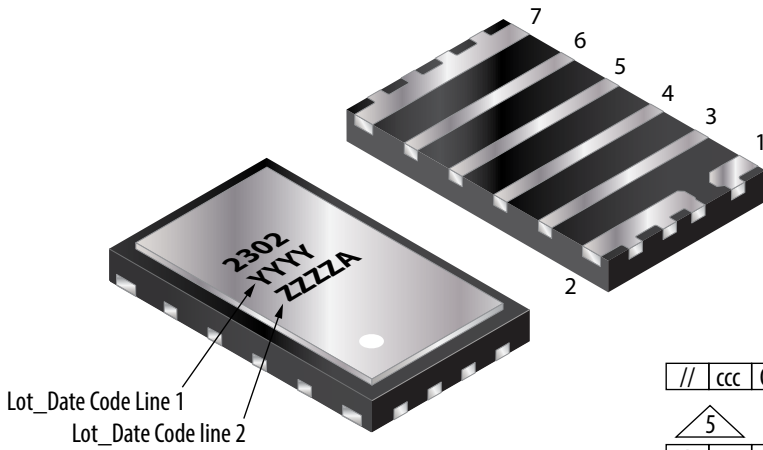

Lot_Date Code Line 1
Lot_Date Code line 2

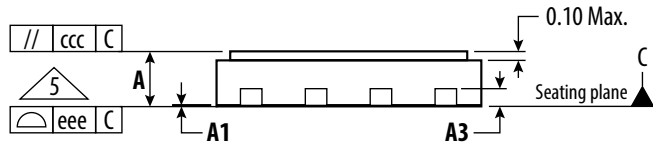

Side View 2

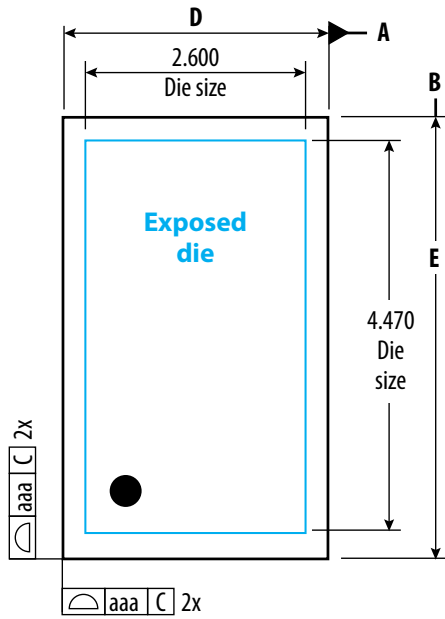

Top View

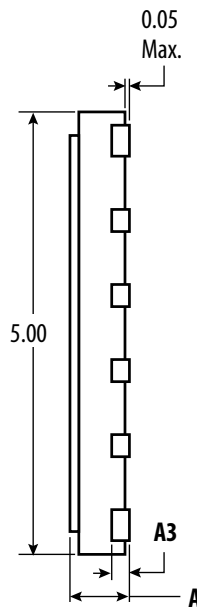

Side View 1

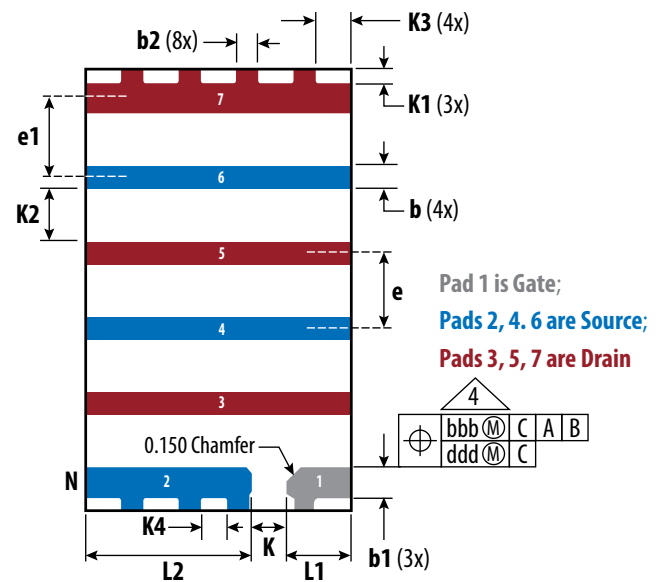

Bottom View

Pad 1 is Gate;
Pads 2, 4, 6 are Source;
Pads 3, 5, 7 are Drain

SYMBOL	Dimension (mm)			Note
	MIN	Nominal	MAX	
A	0.60	0.65	0.70	
A1	0.00	0.02	0.05	
A3		0.20 Ref		
b	0.20	0.25	0.30	4
b1	0.30	0.35	0.40	4
b2	0.20	0.25	0.30	4
D		3.00 BSC		
E		5.00 BSC		
e		0.85 BSC		
e1		0.90 BSC		
L1	0.625	0.725	0.825	
L2	1.775	1.875	1.975	

SYMBOL	Dimension (mm)			Note
	MIN	Nominal	MAX	
K	0.35	0.40	0.45	
K1	0.10	0.15	0.20	
K2	0.55	0.60	0.65	
K3	0.35	0.40	0.45	
K4	0.25	0.30	0.35	
aaa		0.05		
bbb		0.10		
ccc		0.10		
ddd		0.05		
eee		0.08		
N		15		3
NE		6		

Notes:

1. Dimensioning and tolerancing conform to ASME Y14.5-2009
2. All dimensions are in millimeters
3. N is the total number of terminals
4. Dimension b applies to the metallized terminal. If the terminal has a radius on the other end of it, dimension b should not be measured in that radius area.
5. Coplanarity applies to the terminals and all the other bottom surface metallization.

TRANSPARENT VIEW

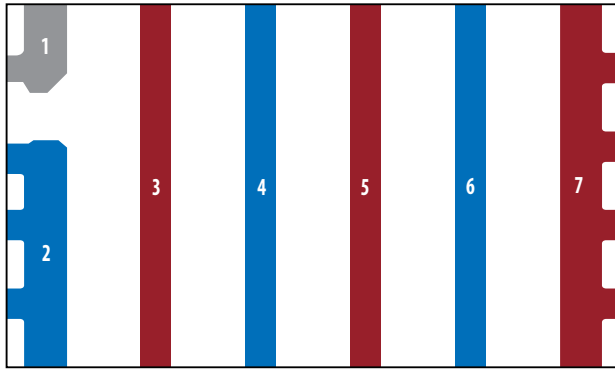

PIN	Description
1	Gate
2	Source
3	Drain
4	Source
5	Drain
6	Source
7	Drain

RECOMMENDED LAND PATTERN

(units in mm)

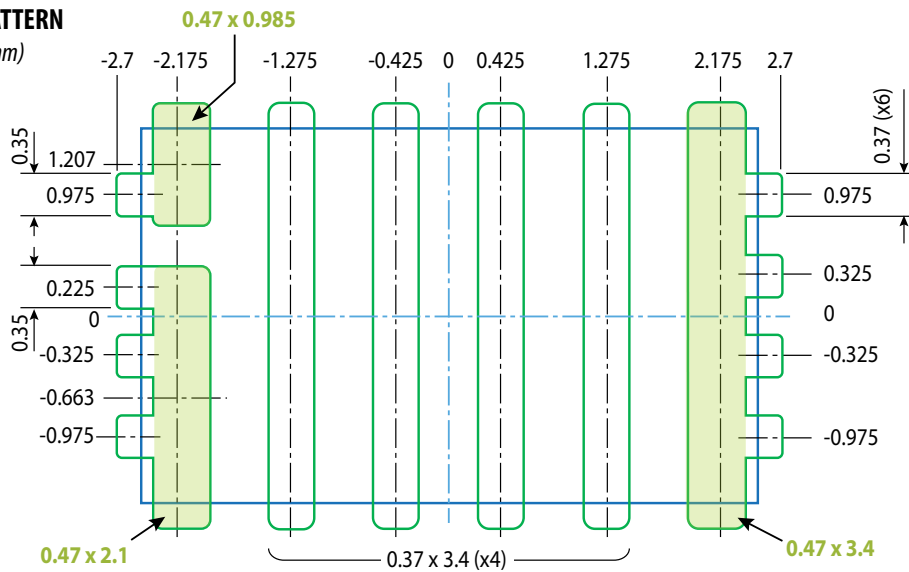

Legend:

Part outline
Mask Opening

Radius = 0.05

Land pattern is solder mask defined

RECOMMENDED STENCIL DRAWING

(units in mm)

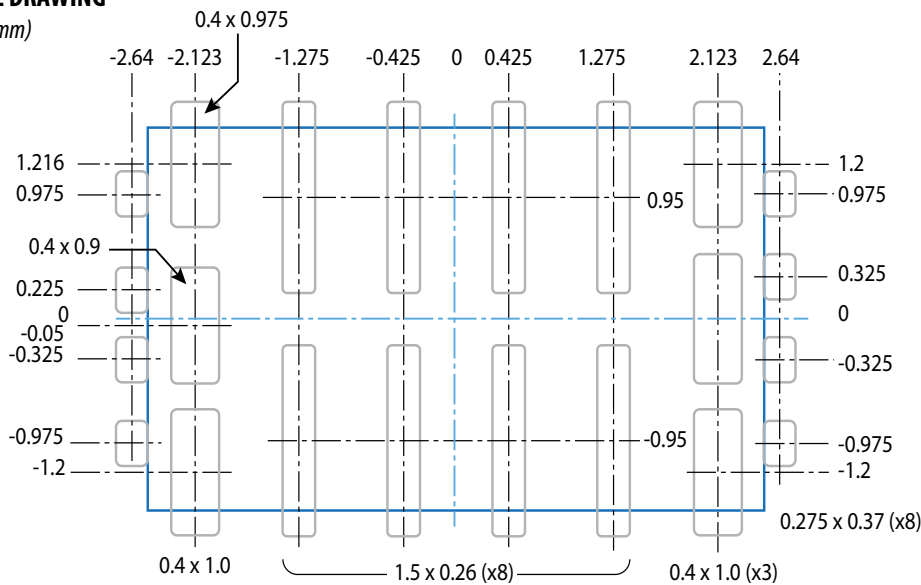

Legend:

Part outline
Stencil opening

Recommended stencil should be 4 mil (100 μm) thick, must be laser cut, openings per drawing. Intended for use with SAC305 Type 4 solder, reference 88.5% metals content.

The corner has a radius of R60.

EPC has tested this stencil design and not found any scooping issues.

**RECOMMENDED
COPPER DRAWING**
(units in mm)

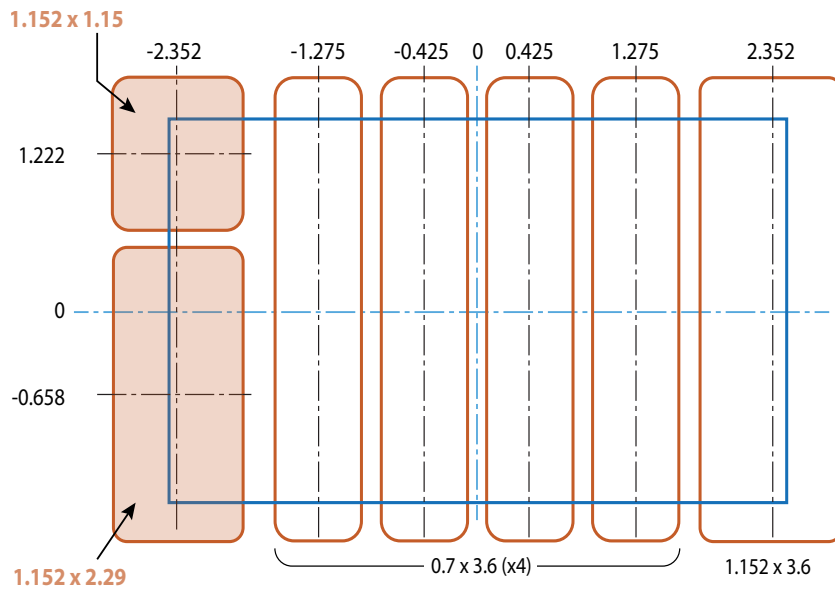

Legend:
Part outline
Copper
 Radius = 0.05

3D COMPOSITE

Legend:

Part outline

Lead frame

Paste

Mask

Copper

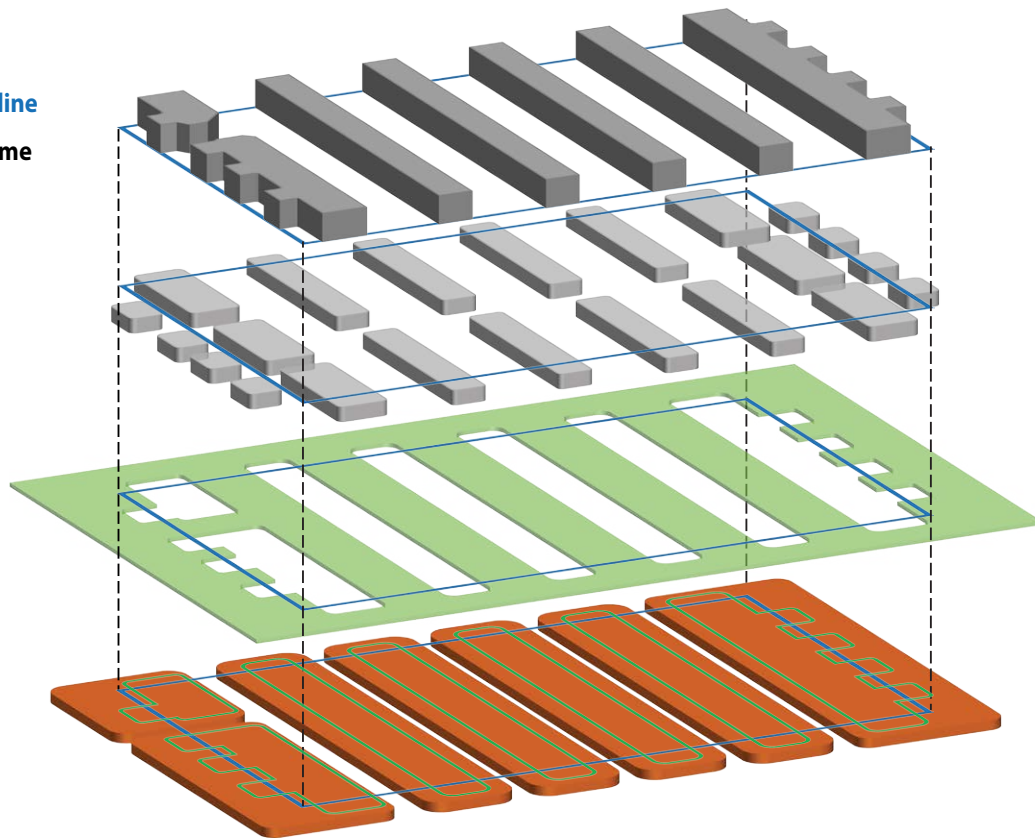

ADDITIONAL RESOURCES AVAILABLE

Solder mask defined pads are recommended for best reliability.

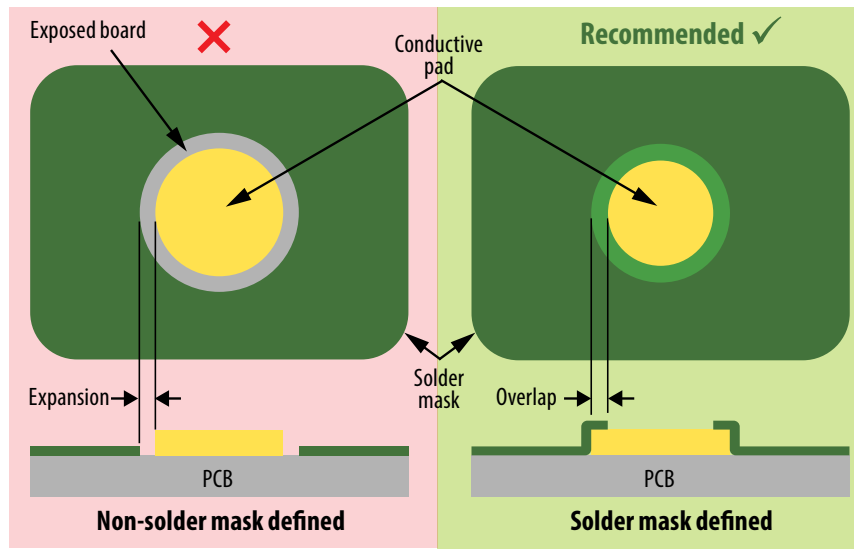

Figure 17: Solder mask defined versus non-solder mask defined pad

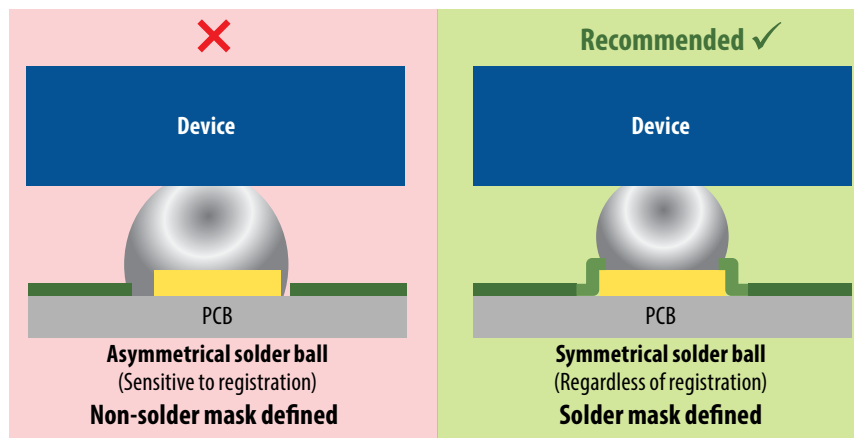

Figure 18: Effect of solder mask design on the solder ball symmetry

- Assembly resources – https://epc-co.com/epc/Portals/0/epc/documents/product-training/Appnote_GaNassembly.pdf
- Library of Altium footprints for production FETs and ICs – <https://epc-co.com/epc/documents/altium-files/EPC%20Altium%20Library.zip>
(for preliminary device Altium footprints, contact EPC)

Efficient Power Conversion Corporation (EPC) reserves the right to make changes without further notice to any products herein to improve reliability, function or design. EPC does not assume any liability arising out of the application or use of any product or circuit described herein; neither does it convey any license under its patent rights, nor the rights of others.

eGaN® is a registered trademark of Efficient Power Conversion Corporation.
EPC Patent Listing: <https://epc-co.com/epc/about-epc/patents>

Information subject to change without notice.
Revised November, 2024