

DATA SHEET

CARBON FILM RESISTORS

Flameproof

FCR Series

$\pm 2\%$, $\pm 5\%$

1/4W to 3W

RoHS compliant & Halogen Free



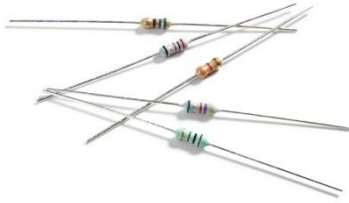

ORDERING INFORMATION

Part number of the flameproof carbon film resistor are identified by the series, power rating, tolerance, packing, temperature coefficient, forming and resistance value.

APPLICATIONS

- All general purpose applications
- Power applications

FEATURES

- Wide resistance range
- High stability
- Flameproof coating equivalent to UL-94V-0
- RoHS compliant & halogen-free

PART NUMBER

<u>FCR</u>	<u>200</u>	<u>J</u>	<u>T</u>	<u>-</u>	<u>73-</u>	<u>100R</u>
(1)	(2)	(3)	(4)	(5)	(6)	(7)

(1) SERIES

FCR Series

(2) POWER RATING

-25 = 1/4W	100 = 1W
50S = 1/2W	2WS = 2W
-50 = 1/2W	200 = 2W
1WS = 1W	3WS = 3W

(3) TOLERANCE

G = ±2%	J = ±5%
---------	---------

(4) PACKAGING

R = Reel Pack	B = Bulk
T = Box Pack	

(5) TEMPERATURE COEFFICIENT OF RESISTANCE

- = Based on spec , refer to page 4 Table 2 .

(6) FORMING

26- = 26mm	FK = FK Type
52- = 52.4mm	FFK = F-form Kink
73- = 73mm	FKK = FKK Type
52C = 52.4mm, Φd =0.5±0.02mm	FT = FT Type Forming
M = M-Type Forming	PN = PANAsert
MB = M-form W/flat	AV = AVIsert
F = F Type	

Note:26mm, 52.4mm and 73mm represent dimension A of the axial type, please refer to the category of AXIAL/REEL TAPE SPECIFICATION for the detail.

(7) RESISTANCE VALUE

E24 Series
 Example:
 100R = 100Ω, 10K = 10,000Ω, 1M = 1,000,000Ω

DIMENSIONS

Unit: mm

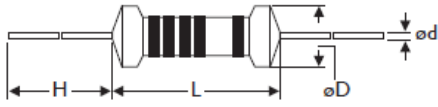

Normal	Miniature	L	ψD	H	ψd
FCR -25	FCR 50S	6.3 ± 0.5	2.4 ± 0.2	28 ± 2.0	0.55 ± 0.05
FCR -50	FCR 1WS	9.0 ± 0.5	3.3 ± 0.3	26 ± 2.0	0.55 ± 0.05
FCR 100	FCR 2WS	11.5 ± 1.0	4.5 ± 0.5	35 ± 2.0	0.8 ± 0.05
FCR 200	FCR 3WS	15.5 ± 1.0	5.0 ± 0.5	33 ± 2.0	0.8 ± 0.05

DERATING CURVE

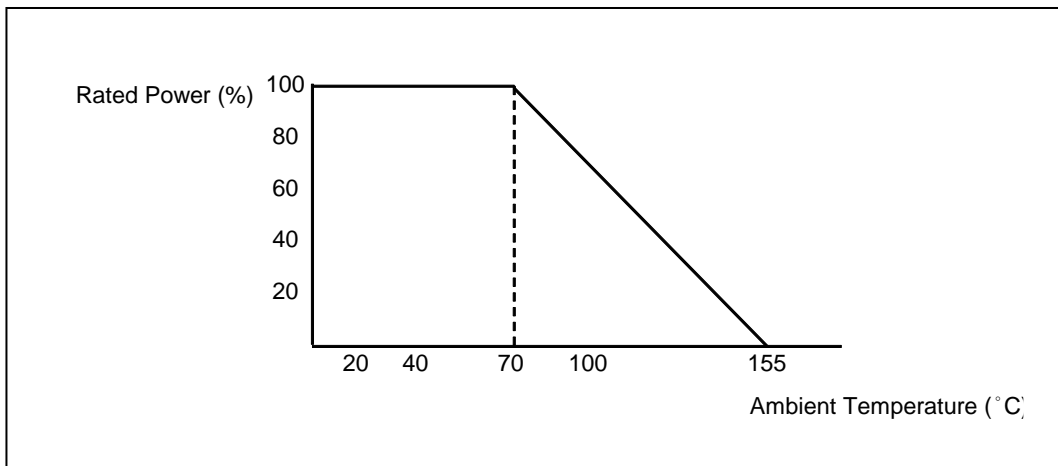

ELECTRICAL CHARACTERISTICS

TABLE 1

CHARACTERISTICS	FCR-25	FCR50S	FCR-50	FCR1WS	FCR100	FCR2WS	FCR200	FCR3WS
Power Rating at 70 °C	1/4W	1/2W	1/2W	1W	1W	2W	2W	3W
Maximum Working Voltage	250V	300V	350V	400V	500V	500V	500V	500V
Maximum Overload Voltage	500V	600V	700V	800V	1000V	1000V	1000V	1000V
Voltage Proof on Insulation	400V	400V	500V	500V	500V	500V	500V	500V
Resistance Range	1Ω ~ 10MΩ for E24 series value							
Operating Temp. Range	- 55°C to +155°C							
Temperature Coefficient	See table 2							

Note: For resistance value out of above range is by request.

TABLE 2 TEMPERATURE COEFFICIENT

TYPE	Temp. Coefficient ppm/°C		
	Under 100KΩ	100K ~ 1MΩ	1M ~ 10MΩ
FCR100, FCR200, FCR2WS FCR3WS	± 350	-500~0	-1500~0
FCR-25 , FCR-50,FCR50S , FCR1WS	- 500 ~ + 350	-700~0	-1500~0

TEST AND REQUIRMENTS

TEST	TEST METHOD	PROCEDURE	APPRAISE
Short Time Overload	IEC 60115-1 4.13	2.5 times RCWV for 5 sec.(Not more than maximum overload voltage)	±0.75%+0.05Ω
Voltage Proof on Insulation	IEC 60115-1 4.7	In V-Block for 60 sec. test voltage as above table	No Breakdown
Temperature Coefficient	IEC 60115-1 4.8	Between -55°C to +155°C	By Type
Insulation Resistance	IEC 60115-1 4.6	In V-Block for 60 sec.	>1,000MΩ
Solderability	IEC 60115-1 4.17	245±5°C for 3±0.5 Sec.	95% Min. coverage
Solvent Resistance of Marking	IEC 60115-1 4.30	IPA for 5±0.5 Min. with ultrasonic	No deterioration of coatings and markings
Robustness of Terminations	IEC 60115-1 4.16	Direct load for 10 Sec. in the direction of the terminal leads	≥2.5Kg(24.5N)
Periodic-pulse Overload	IEC 60115-1 4.39	4 times RCWV(or Umax., whichever less) 10,000 cycles (1 Sec. on, 25 Sec.off)	±1.0%+0.05Ω
Damp Heat Steady State	IEC 60115-1 4.24	40±2°C,90-95% RH for 56 days, loaded with 0.1 times RCWV (or Umax., whichever less)	±3.0%+0.05Ω
Endurance at 70°C	IEC 60115-1 4.25	70±2°C at RCWV(or Umax., whichever less) for 1,000 Hr.(1.5 Hr.on,0.5 Hr. off)	±3.0%+0.05Ω
Temperature Cycling	IEC 60115-1 4.19	-55°C → Room Temp. → +155°C → Room Temp.(5 cycles)	±1.0%+0.05Ω
Resistance to Soldering Heat	IEC 60115-1 4.18	260±3°C for 10±1 Sec., immersed to a point 3±0.5mm from the body	±1.0%+0.05Ω
Accidental Overload Test	IEC 60115-1 4.26	4 times RCWV(or Umax., whichever less) for 1 Min.	No evidence of flaming or arcing

Note:

RCWV (Rated Continuous Working Voltage):

The DC or AC (rms) continuous working voltage corresponding to the rated power is determined by the following formula:

$$V = \sqrt{(P \times R)}$$

or max. working voltage whichever is less

Where

V=Continuous rated DC or AC (rms) working voltage (V)

P=Rated power (W)

R=Resistance value (Ω)

AXIAL / REEL TAPE SPECIFICATION

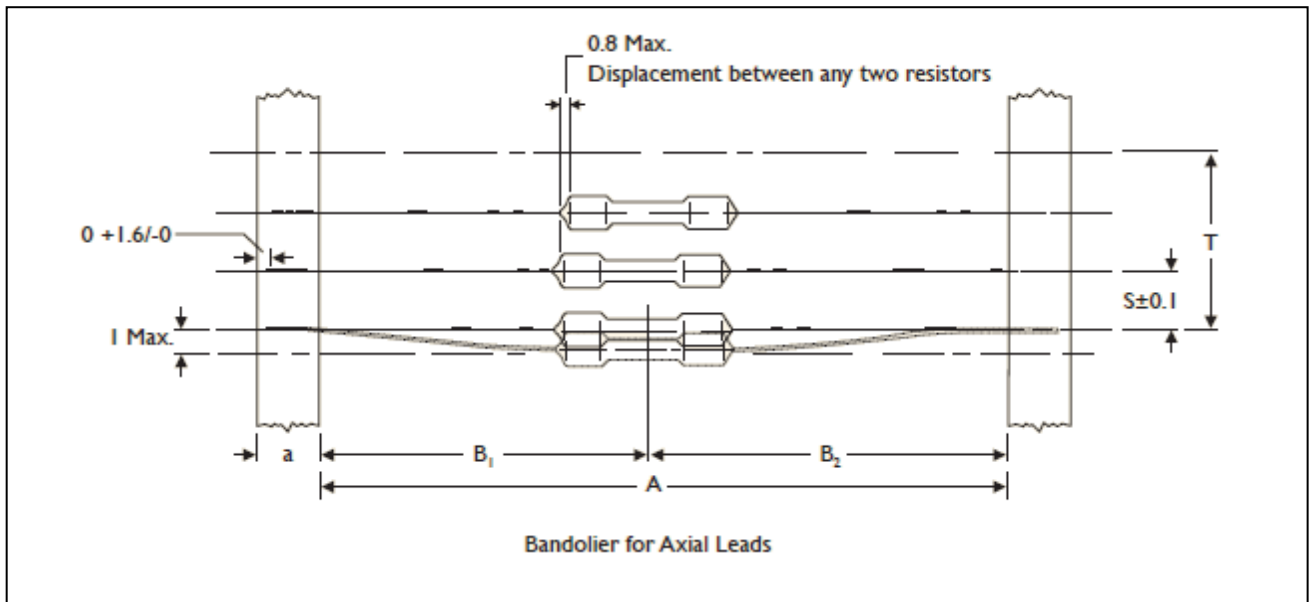

Unit: mm

Normal	Miniature	a	A	B1-B2 (Max.)	S (spacing)	T (max. deviation of spacing)
FCR-25	FCR50S	6 ± 0.5	52.4 ± 1.5	1.2	5	
			26.0 ± 1.5	1		
FCR-50	FCR1WS	6 ± 0.5	52.4 ± 1.5	1.2	5	
FCR100	FCR2WS	6 ± 0.5	73.0 ± 1.5	1.5	5	1 mm per 10 spacing, 0.5 mm per 5 spacing,
			52.4 ± 1.5	1.2		
FCR200	FCR3WS	6 ± 0.5	73.0 ± 1.5	1.5	10	
			52.4 ± 1.5	1.2		

TAPE ON REEL PACKING

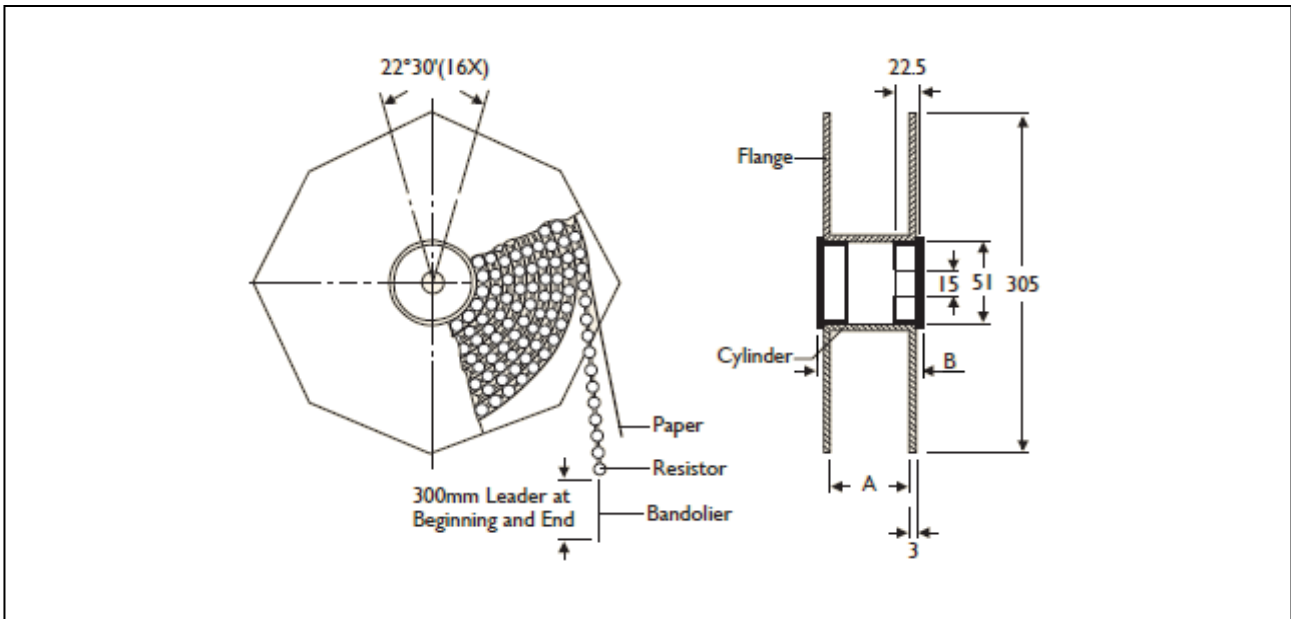

TYPE

Unit: mm/piece

Normal	Miniature	Across Flange(A)	B	Quantity Per Reel
FCR-25	FCR50S	66.5	75.5	5,000
FCR-50	FCR1WS	66.5	75.5	2,500
FCR100	FCR2WS	87	96	2,000
FCR200	FCR3WS	87	96	1,000

TAPE ON BOX PACKING

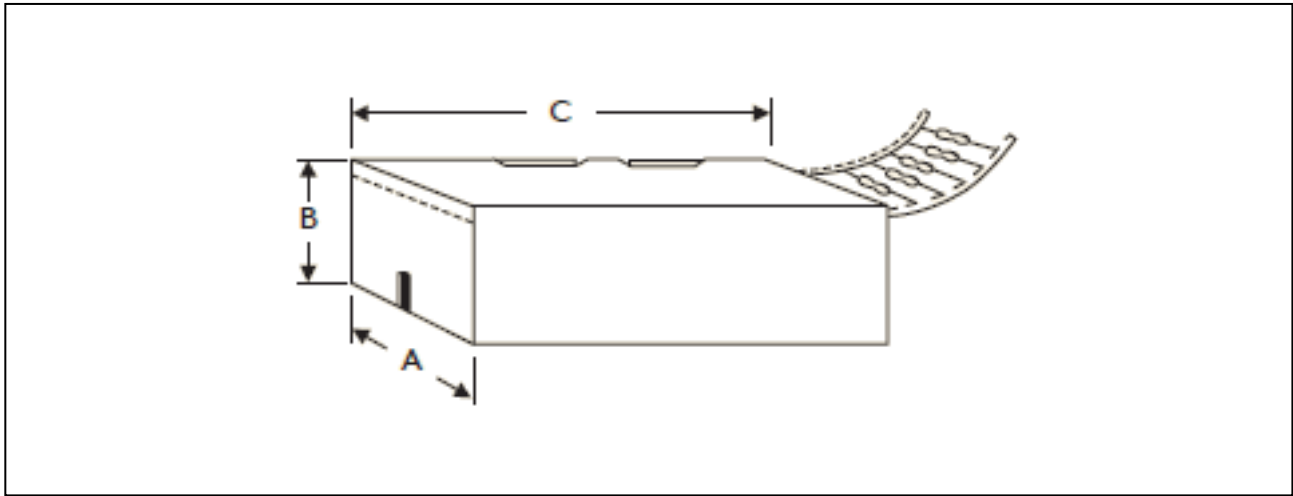

TYPE		DIMENSIONS			Unit: mm/piece
Normal	Miniature	A	B	C	Quantity Per Box
FCR-25	FCR50S	48	102	255	5,000
FCR-25	FCR50S	81	104	260	5,000
FCR-50	FCR1WS	73	45	258	1,000
FCR100	FCR2WS	81	91	260	1,000
FCR100	FCR2WS	103	78	260	1,000
FCR200	FCR3WS	81	91	260	1,000
FCR200	FCR3WS	103	94	260	1,000

BULK PACKING

Normal	Miniature	Piece/Per Inner Box	Bag/Per Inner Box	Piece Per Bag
CFR-25	CFR50S	10,000	10	1,000
CFR-50	CFR1WS	5,000	5	1,000
CFR-100	CFR2WS	2,000	4	500
CFR200	CFR3WS	1,000	2	500

FORMING

M TYPE

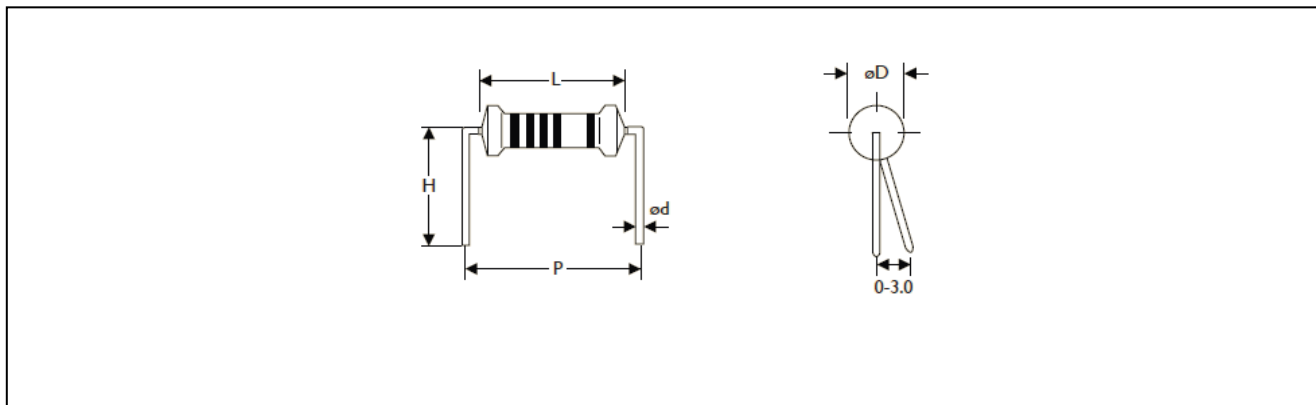

TYPE		DIMENSIONS					Unit: mm
Normal	Miniature	L	$\varnothing D$	$\varnothing d$	P	H	
FCR-25	FCR50S	6.3 ± 0.5	2.4 ± 0.2	0.55 ± 0.05	10.0 ± 1	10.0 ± 1	
FCR-50	FCR1WS	9.0 ± 0.5	3.3 ± 0.3	0.55 ± 0.05	12.5 ± 1	10.0 ± 1	
FCR100	FCR2WS	11.5 ± 1.0	4.5 ± 0.5	0.8 ± 0.05	15.0 ± 1	12.5 ± 1	
FCR200	FCR3WS	15.5 ± 1.0	5.0 ± 0.5	0.8 ± 0.05	20.0 ± 1	15.0 ± 1	

MB TYPE

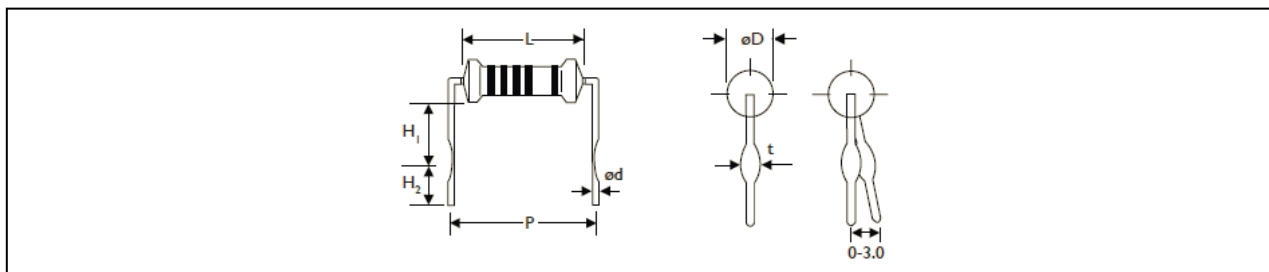

TYPE		DIMENSIONS							Unit: mm
Normal	Miniature	L	$\varnothing D$	$\varnothing d$	P	H1	H2	t	
FCR-25	FCR50S	6.3 ± 0.5	2.4 ± 0.2	0.55 ± 0.05	10.0 ± 1	6.0 ± 1	5.0 ± 1	1.2 ± 0.2	
FCR-50	-	9.0 ± 0.5	3.3 ± 0.3	0.55 ± 0.05	12.5 ± 1	6.0 ± 1	5.0 ± 1	1.2 ± 0.2	
-	FCR1WS	9.0 ± 0.5	3.3 ± 0.3	0.55 ± 0.05	12.5 ± 1	6.0 ± 1	5.0 ± 1	1.4 ± 0.2	
FCR100	FCR2WS	11.5 ± 1.0	4.5 ± 0.5	0.8 ± 0.05	15.0 ± 1	6.0 ± 1	5.0 ± 1	1.4 ± 0.2	
FCR200	FCR3WS	15.5 ± 1.0	5.0 ± 0.5	0.8 ± 0.05	20.0 ± 1	10.0 ± 1	5.0 ± 1	1.4 ± 0.2	

MHA TYPE

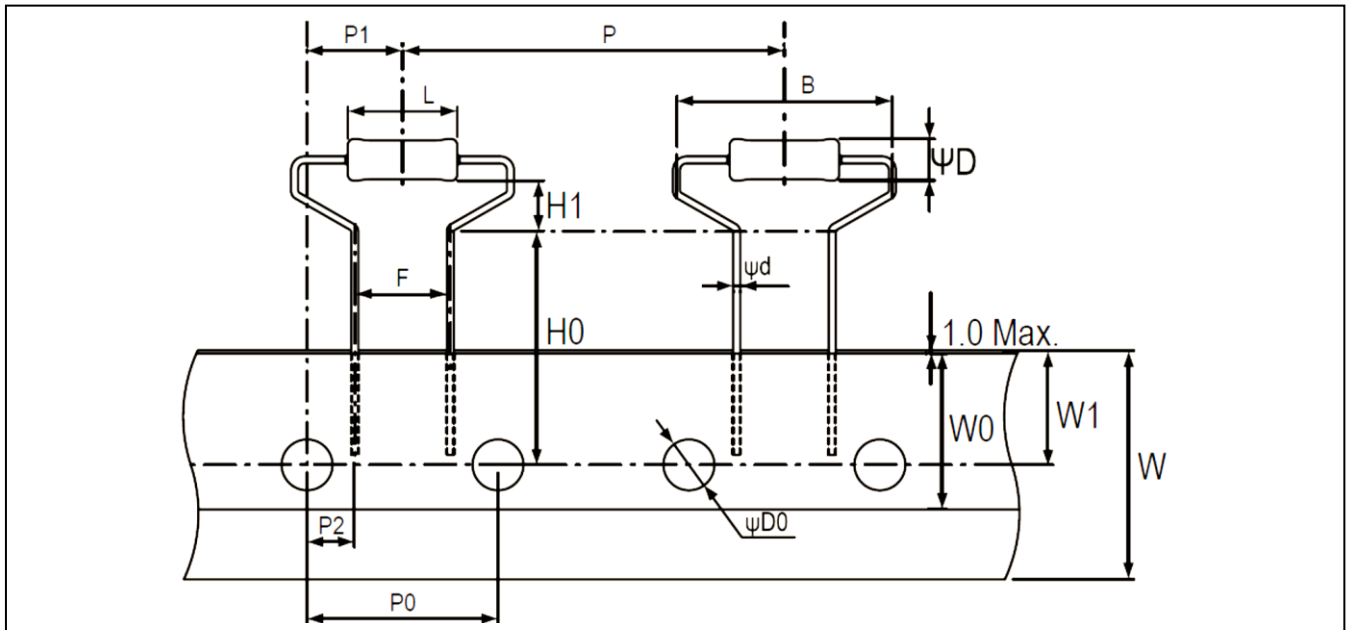

TYPE		DIMENSIONS								Unit: mm
Normal	Miniature	L	ψD	ψd	B	H0	H1	P	P0	
		9.0±0.5	3.3±0.3	0.55±0.05	17.5Max	19.0±1.0	4.0±1.0	30.0±1.0	15.0±0.3	
FCR -50	FCR 1WS	P1	P2	F	W	W0	W1	ψD0		
		7.5±1.0	3.75±0.5	7.5±0.5	18.0±0.5	5.0Min	9.0±0.5	4.0±0.2		

MHB TYPE

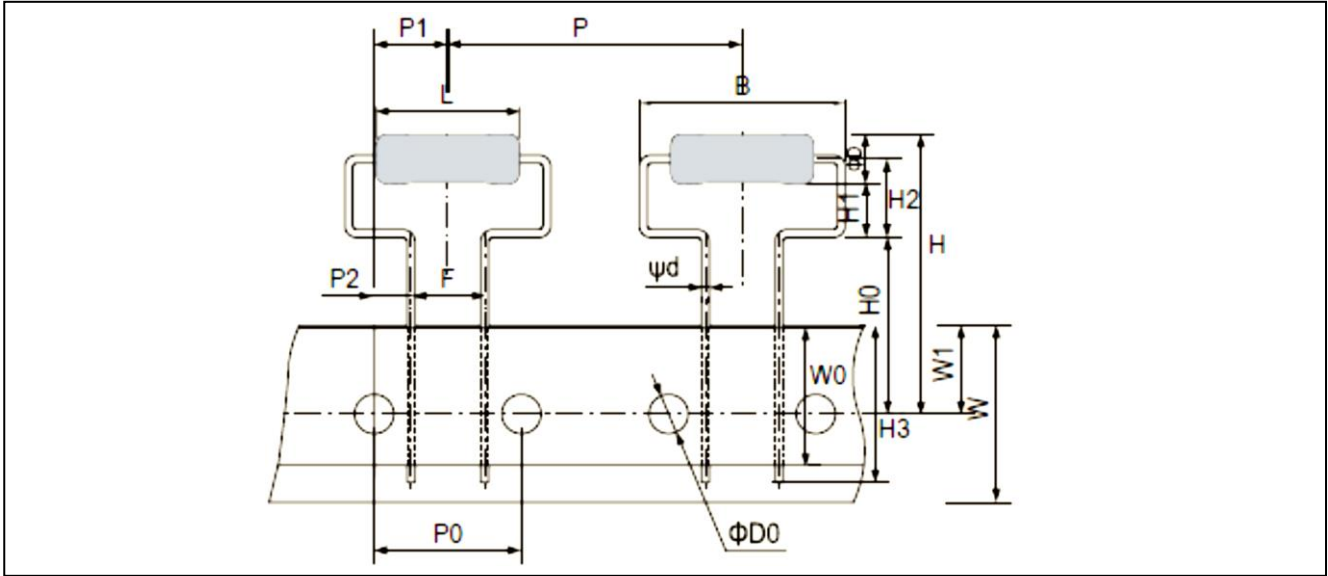

TYPE		DIMENSIONS									Unit: mm
Normal	Miniature	L	ΨD	Ψd	B	H	H0	H1	H2	H3	
		15.5±1.0	5.0±0.5	0.8±0.05	21.0Max.	30Max.	18.0±1.0	5.5(Ref.)	8.0±1.5	16Max.	
FCR200	FCR3WS	P	P0	P1	P2	F	W	W0	W1	$\Psi D0$	
		30.0±1.0	15.0±0.3	7.5±1.0	3.75±0.8	7.5±0.5	18.0±0.5	5.0Min.	9.0±0.5	4.0±0.3	

MHC TYPE

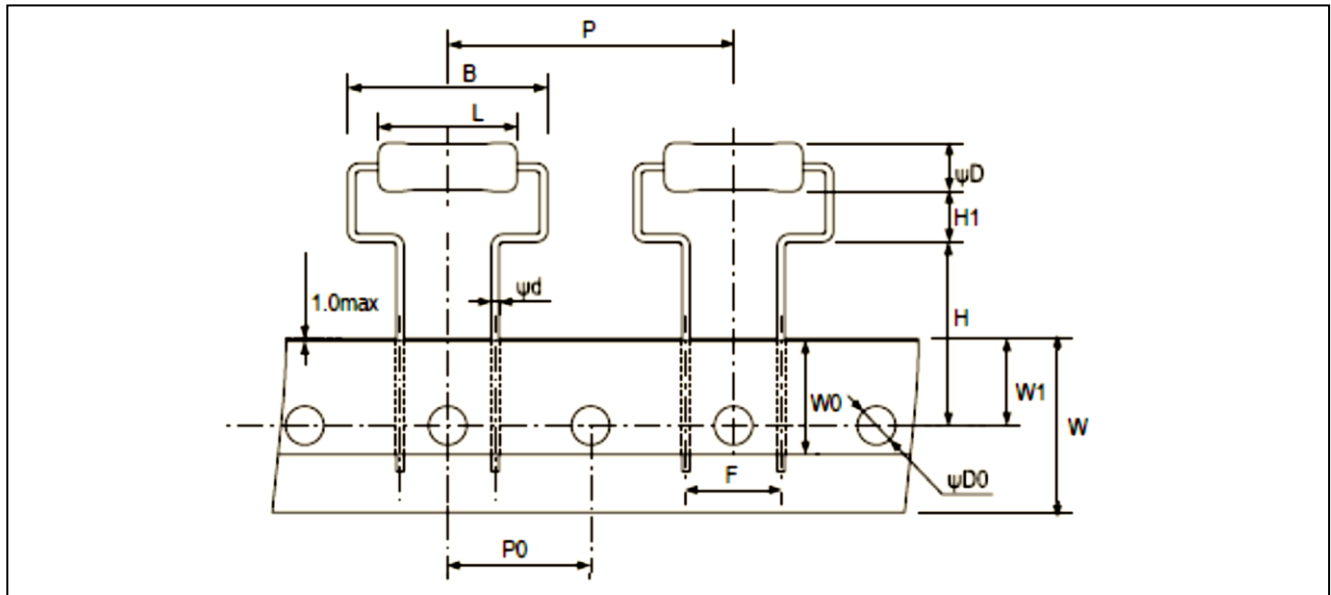

TYPE		DIMENSIONS									Unit: mm
Normal	Miniature	L	ΨD	Ψd	B	H	H1	P	P0		
		15.5±1.0	5.0±0.5	0.8±0.05	21.0Max.	19.0±1.0	5.25±1.0	30.0±1.0	15.0±0.3		
FCR200	FCR3WS	F	W	W0	W1	$\Psi D0$					
		10.0±0.5	18.0±0.5	5.0Min.	9.0±0.5	4.0±0.2					

F TYPE

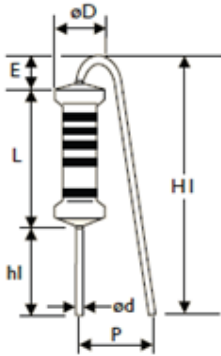

FK TYPE

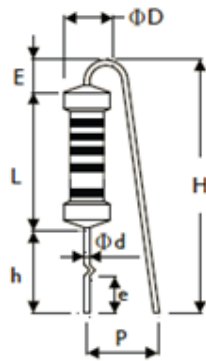

FFK TYPE

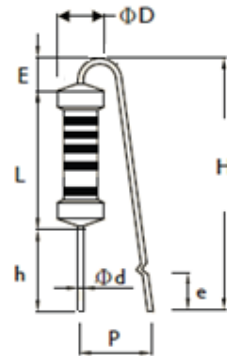

FKK TYPE

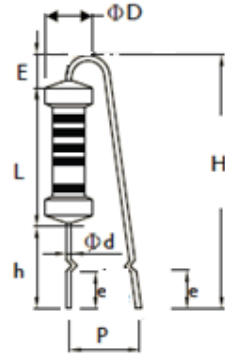

TYPE		DIMENSIONS										Unit: mm
Normal	Miniature	L	ψD	ψd	P	h	H Max.	hI	HI Max.	E Max.	e	
FCR-50	FCR1WS	9.0±0.5	3.3±0.3	0.55±0.05	6±1	8±1	22	5±1	18.5	3.5	3.5±1	
FCR100	FCR2WS	11.5±1	4.5±0.5	0.8±0.05	6±1	8±1	24	5±1	20	3.5	3.5±1	
FCR200	FCR3WS	15.5±1	5.0±0.5	0.8±0.05	8±1	8±1	28	5±1	25	3.5	3.5±1	

PN TYPE (Taping Pack)

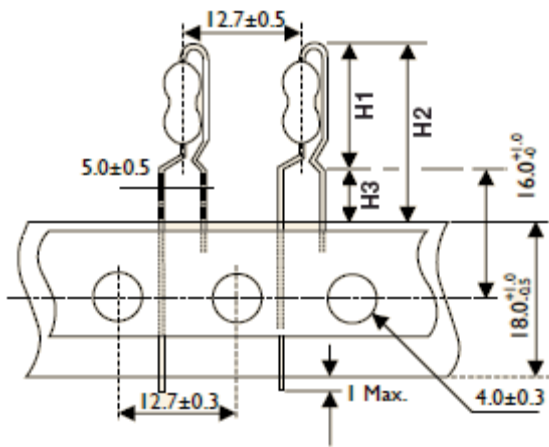

AV TYPE (Taping Pack)

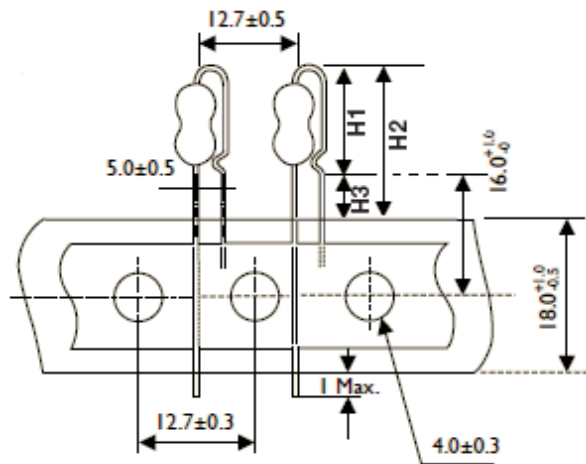

TYPE		DIMENSIONS			Unit: mm
Normal	Miniature	H1 Max.	H2 Max.	H3 Max.	
FCR-25	FCR50S	13	21.5	8.5	
FCR-50	FCR1WS	17	25.5	8.5	
FCR100	FCR2WS	19	27.5	8.5	

TYPE		DIMENSIONS			Unit: mm
Normal	Miniature	H1 Max.	H2 Max.	H3 Max.	
FCR-25	FCR50S	11.5	20	8.5	
FCR-50	FCR1WS	14.5	23	8.5	
FCR100	FCR2WS	17.5	26	8.5	

FT TYPE (Taping Pack)

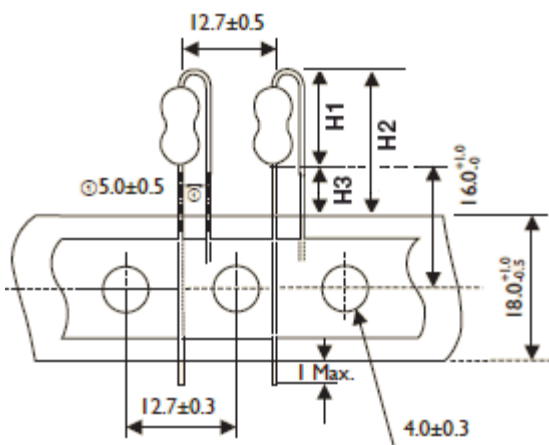

TYPE		DIMENSIONS			Unit: mm
Normal	Miniature	H1 Max.	H2 Max.	H3 Max.	
FCR-25	FCR50S	10	18.5	8.5	
FCR-50	FCR1WS	13	21.5	8.5	
FCR100	FCR2WS	16	24.5	8.5	

MARKING

5-BAND-CODE

±2%, ±5%

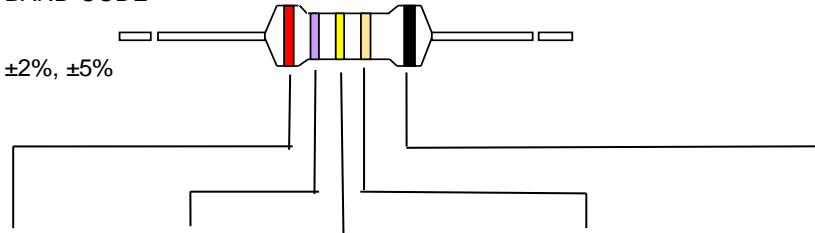

COLOR	1st BAND	2nd BAND	MULTIPLIER	TOLERANCE
BLACK	0	0	1Ω	FCR series
BROWN	1	1	10Ω	
RED	2	2	100Ω	± 2% (G)
ORANGE	3	3	1KΩ	
YELLOW	4	4	10KΩ	
GREEN	5	5	100K	
BLUE	6	6	1MΩ	
VIOLET	7	7	10MΩ	
GREY	8	8	0.001Ω	
WHITE	9	9	0.0001Ω	
GOLD			0.1Ω	± 5 % (J)
SILVER			0.01Ω	

REVISION HISTORY

REVISION	DATE	CHANGE NOTIFICATION	DESCRIPTION
Version 3	Apr.2, 2024	-	- Added forming code description for part number
Version 2	Oct.11, 2023	-	- Update marking
Version 1	Aug.31, 2023	-	- Update legal disclaimer
Version 0	Aug.2, 2021	-	- First issue of this specification

“ Yageo reserves all the rights for revising the content of this datasheet without further notification, as long as the products itse If are unchanged. Any product change will be announced by PCN.”

LEGAL DISCLAIMER

YAGEO, its distributors and agents (collectively, "YAGEO"), hereby disclaims any and all liabilities for any errors, inaccuracies or incompleteness contained in any product related information, including but not limited to product specifications, datasheets, pictures and/or graphics. YAGEO may make changes, modifications and/or improvements to product related information at any time and without notice.

YAGEO makes no representation, warranty, and/or guarantee about the fitness of its products for any particular purpose or the continuing production of any of its products. To the maximum extent permitted by law, YAGEO disclaims (i) any and all liability arising out of the application or use of any YAGEO product, (ii) any and all liability, including without limitation special, consequential or incidental damages, and (iii) any and all implied warranties, including warranties of fitness for a particular purpose, non-infringement and merchantability.

YAGEO products are designed for general purpose applications under normal operation and usage conditions. Please contact YAGEO for the applications listed below which require especially high reliability for the prevention of defects which might directly cause damage to the third party's life, body or property: Aerospace equipment (artificial satellite, rocket, etc.), Atomic energy-related equipment, Aviation equipment, Disaster prevention equipment, crime prevention equipment, Electric heating apparatus, burning equipment, Highly public information network equipment, data-processing equipment, Medical devices, Military equipment, Power generation control equipment, Safety equipment, Traffic signal equipment, Transportation equipment and Undersea equipment, or for any other application or use in which the failure of YAGEO products could result in personal injury or death, or serious property damage. Particularly **YAGEO Corporation and its affiliates do not recommend the use of commercial or automotive grade products for high reliability applications or manned space flight.**

Information provided here is intended to indicate product specifications only. YAGEO reserves all the rights for revising this content without further notification, as long as products are unchanged. Any product change will be announced by PCN.