

FPC/FFC Connectors

(Display, LED Power)

FFC 1.0 Pitch 8P NON-ZIF

Applications | Mobile device, Display, PC

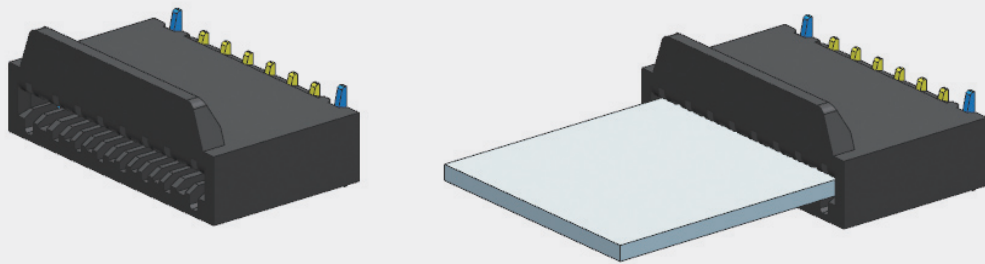

- ▶ 1.0mm Pitch, 5.5mm Height
- ▶ Applicable for FFC thickness is 0.40±0.03mm

Code & Specification

Mating Size / Unit : (mm)

Product Code	Pitch (mm)	No. of Contacts	Width (mm)	Height (mm)	Length	Remark
FN100-Z06B-C55	1.00	6	3.45	5.50	9.20	-
FN100-Z08B-C55	1.00	8	3.45	5.50	11.20	-

Current Rating	Contact Resistance	Withstanding Voltage	Temperature Range
1.0A Max.	30mΩ [Max.]	DC 500V	-35°C ~ 85°C

FPC/FFC Connectors

(Display, LED Power)

FFC 1.0 Pitch 8P NON-ZIF

Applications | Mobile device, Display, PC

Product Specification

Ratings	Rated current	1.0A Max. / contact	Operating temperature range	-35°C to +85°C	Storage temperature range	15°C to 35°C
	Rated voltage	150V AC, DC	Operating humidity range	85%RH 2	Storage humidity range	65%RH

- 1) Including terminal temperature rise.
- 2) Storage area is to be free of corrosive gases and dew formation.

Applicable FFC Specification T=0.4±0.03mm

Items	Specifications	Conditions
1. Contact resistance	30mΩ Max. / contact	Closed circuit Current : 10mA. Opened circuit voltage : 20mV
2. Insulation resistance	50MΩ Min.	Test voltage : 500V D.C.
3. Withstanding voltage	No flashover or dielectric breakdown	DC 500V for 5sec
4. Insertion Force	0.4Kgf Max. / pin	FFC shall be insert at a speed of 25mm/min and measured the insertion force.
5. Durability	No damage or mechanical defect Contact resistance : 50mΩ Max. / contact	Number of cycles : 30 cycles.
6. Vibration	No damage or mechanical defect No interruption over 1μ sec. No FPC drop out Contact resistance : 50mΩ Max. / contact	Amplitude: 1.5mm Frequency: 10~55~10Hz Duration : X,Y,Z axis each 2 hours.
7. Humidity	No damage or mechanical defect Contact resistance : 50mΩ Max. / contact Insulation Resistance : 50MΩ Min.	Temperature : 40°C±2°C Humidity : 90% ~ 95% Duration : 96hr
8. Solder heat resistance	Visual inspection : Connector shall meet the design and dimensional requirements of each drawings.	Reflow : Refer to the recommended reflow condition.

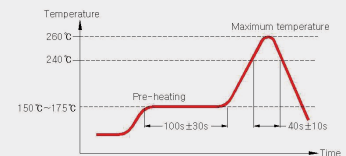

Materials / Finish

Part	Materials	Finish	UL Regulation
Base Insulation	PA4T	Black	UL94V-0
Contact Terminal	Phosphor Bronze	Sn over Nickel	-
Fitting Nail	Phosphor Bronze	Sn over Nickel	-

FPC/FFC Connectors

(Display, LED Power)

FFC 1.0 Pitch 8P NON-ZIF

Applications | Mobile device, Display, PC

Product Drawing

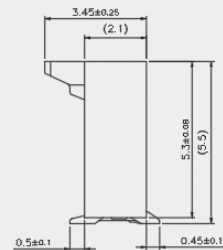
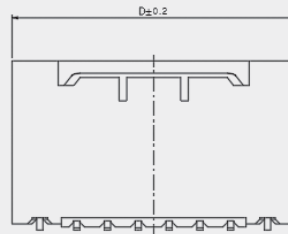
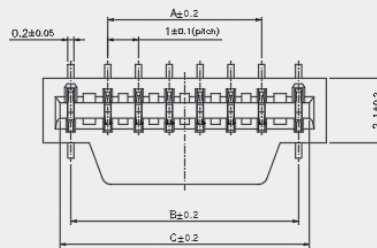
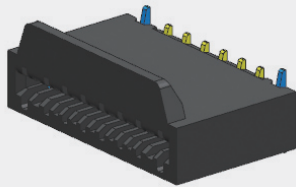

Recommended PCB , Metal Mask Layout

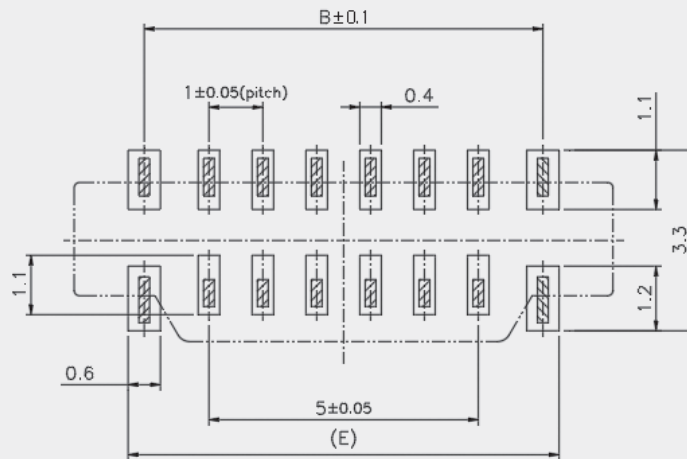

Mating Size / Unit : (mm)

Product No.	No. of Contacts	A	B	C	D	E
FN100-Z06B-C55	6	5.00	7.40	8.10	9.20	8.00
FN100-Z08B-C55	8	7.00	9.40	10.10	11.20	10.00