

200-V half-bridge driver with shutdown and V_{CC} & V_{BS} UVLO

Features

- Gate drive supplies up to 20 V per channel
- Undervoltage lockout for V_{CC} , V_{BS}
- 3.3 V, 5 V, 15 V input logic compatible
- Tolerant to negative transient voltage
- Designed for use with bootstrap power supplies
- Cross-conduction prevention logic
- Matched propagation delay for both channels
- Internal set deadtime
- High-side output in phase with input
- Shutdown input turns off both channels
- -40°C to 125°C operating range
- RoHS compliant

Description

The IRS2008 is a high voltage, high speed power MOSFET and IGBT driver with dependent high and low side referenced output channels. Proprietary HVIC and latch immune CMOS technologies enable ruggedized monolithic construction. The logic input is compatible with standard CMOS or LSTTL output, down to 3.3 V logic. The output drivers feature a high pulse current buffer stage designed for minimum driver cross-conduction. The floating channel can be used to drive an N-channel power MOSFET or IGBT in the high side configuration which operates up to 200 V. Propagation delays are matched to simplify the HVIC's use in high frequency applications.

Product Summary

V_{OFFSET}	$\leq 200V$
V_{OUT}	10 V – 20 V
I_{O+} & I_{O-} (typ.)	290 mA & 600 mA
t_{ON} & t_{OFF} (typ.)	680 ns & 150 ns
Deadtime (typ.)	520 ns

Package Options

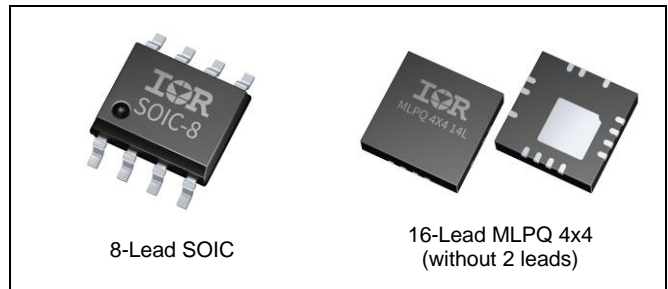

Typical Applications

- Appliance motor drives, Stepper motor, Servo drives
- Micro inverter drives
- General purpose three phase inverters
- Light electric vehicles (e-bikes, e-scooters, e-toys)
- Wireless Charging
- General battery driven applications

Base Part Number	Package Type	Standard Pack		Orderable Part Number
		Form	Quantity	
IRS2008S	8-Lead SOIC	Tape and Reel	2500	IRS2008STRPBF
		Tube/Bulk	95	IRS2008SPBF
IRS2008M	14-Lead MLPQ 4x4	Tape and Reel	3000	IRS2008MTRPBF

Typical Connection Diagram

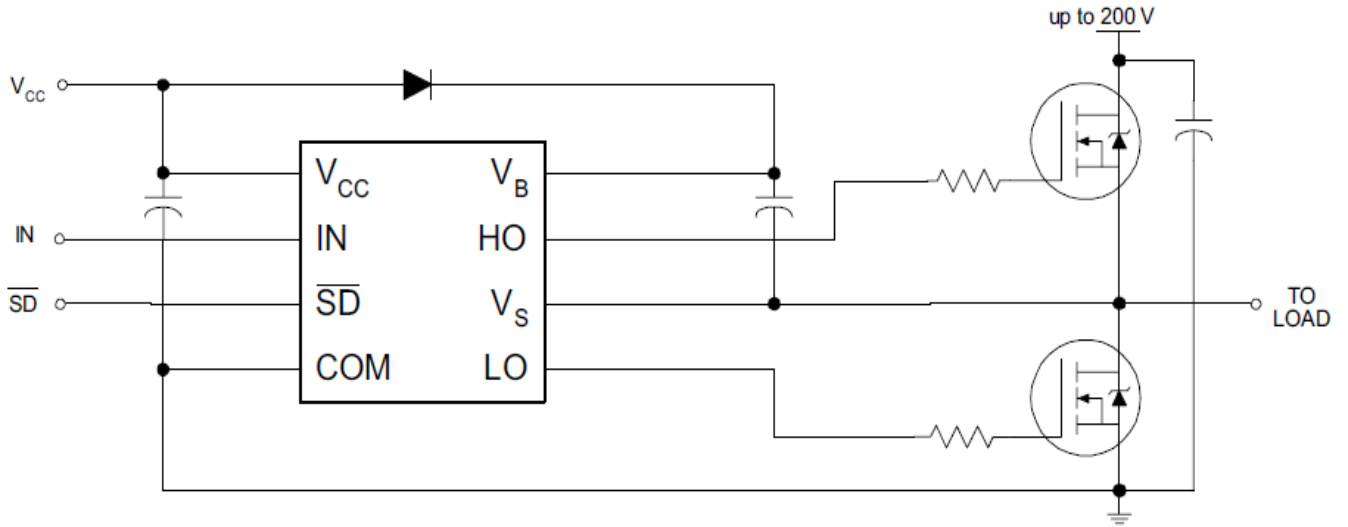

(Refer to Lead Assignments for correct pin configuration). This diagram shows electrical connections only. Please refer our Application Notes & DesignTips for proper circuit board layout.

Absolute Maximum Ratings

Absolute maximum ratings indicate sustained limits beyond which damage to the device may occur. All voltage parameters are absolute voltages referenced to COM unless otherwise stated in the table. The thermal resistance and power dissipation ratings are measured under board mounted and still air conditions.

Symbol	Definition	Min.	Max.	Units	
V _{CC}	Low side supply voltage	-0.3	25 [†]	V	
V _{IN}	Logic input voltage (IN & \overline{SD})	COM - 0.3	V _{CC} + 0.3		
V _B	High-side floating well supply voltage	-0.3	225		
V _S	High-side floating well supply return voltage	V _B - 25	V _B + 0.3		
V _{HO}	Floating gate drive output voltage	V _S - 0.3	V _B + 0.3		
V _{LO}	Low-side output voltage	COM - 0.3	V _{CC} + 0.3		
COM	Power ground	V _{CC} - 25	V _{CC} + 0.3		
dV _S /dt	Allowable V _S offset supply transient relative to COM	—	50	V/ns	
P _D	Package power dissipation @ T _A ≤ +25°C	8-Lead SOIC	—	0.625	W
		14-Lead MLPQ 4x4	—	2.08	
R _{thJA}	Thermal resistance, junction to ambient	8-Lead SOIC	—	200	°C/W
		14-Lead MLPQ 4x4	—	36	
T _J	Junction temperature	—	150	°C	
T _S	Storage temperature	-55	150		
T _L	Lead temperature (soldering, 10 seconds)	—	300		

† All supplies are tested at 25V.

Recommended Operating Conditions

For proper operation, the device should be used within the recommended conditions. All voltage parameters are absolute voltages referenced to COM unless otherwise stated in the table. The offset rating is tested with supplies of (V_{CC} - COM) = (V_B - V_S) = 15V.

Symbol	Definition	Min	Max	Units
V _{CC}	Low-side supply voltage	10	20	V
V _{IN}	Logic input voltage(IN & \overline{SD})	0	V _{CC}	
V _B	High-side floating well supply voltage	V _S + 10	V _S + 20	
V _S	High-side floating well supply offset voltage [†]	COM - 8 [†]	200	
V _{HO}	Floating gate drive output voltage	V _S	V _B	
V _{LO}	Low-side output voltage	COM	V _{CC}	
T _A	Ambient temperature	-40	125	°C

† Logic operation for VS of -8 V to 200 V. Logic state held for Vs of -8 V to -V_{BS}. Please refer to Design Tip DT97-3 for more details.

Static Electrical Characteristics

($V_{CC} - COM$) = ($V_B - V_S$) = 15V. $T_A = 25^\circ\text{C}$ unless otherwise specified. The V_{IN} and I_{IN} parameters are referenced to COM. The V_O and I_O parameters are referenced to respective V_S and COM and are applicable to the respective output leads HO or LO. The V_{CCUV} parameters are referenced to COM. The V_{BSUV} parameters are referenced to V_S .

Symbol	Definition	Min.	Typ.	Max.	Units	Test Conditions
V_{BSUV+}	V_{BS} supply undervoltage positive going threshold	8.0	8.9	9.8	V	
V_{BSUV-}	V_{BS} supply undervoltage negative going threshold	7.4	8.2	9		
V_{BSUVHY}	V_{BS} supply undervoltage hysteresis	—	0.7	—		
V_{CCUV+}	V_{CC} supply undervoltage positive going threshold	8.0	8.9	9.8		
V_{CCUV-}	V_{CC} supply undervoltage negative going threshold	7.4	8.2	9		
V_{CCUVHY}	V_{CC} supply undervoltage hysteresis	—	0.7	—		
I_{LK}	High-side floating well offset supply leakage	—	—	50	μA	$V_B = V_S = 200\text{V}$
I_{QBS}	Quiescent V_{BS} supply current	—	45	75		All inputs are in the off state
I_{QCC}	Quiescent V_{CC} supply current	—	300	520		
V_{OH}	High level output voltage drop, $V_{BIAS}-V_O$	—	0.05	0.2	V	$I_O = 2\text{ mA}$
V_{OL}	Low level output voltage drop, V_O	—	0.02	0.1		
I_{O+}	Output high short circuit pulsed current	200	290	—	mA	$V_O = 0\text{V}$ $PW \leq 10\mu\text{s}$
I_{O-}	Output low short circuit pulsed current	420	600	—		$V_O = 15\text{V}$ $PW \leq 10\mu\text{s}$
V_{IH}	Logic "1" (HO) & Logic "0" (LO) input voltage	2.5	—	—	V	$V_{CC}=10\text{V to }20\text{V}$
V_{IL}	Logic "0" (HO) & Logic "1" (LO) input voltage	—	—	0.8		
$V_{SD,TH+}$	SD input positive going threshold	2.5	—	—		
$V_{SD,TH-}$	SD input negative going threshold	—	—	0.8		
I_{IN+}	Logic "1" Input bias current	—	3	10	μA	$V_{IN} = 5\text{V}$
I_{IN-}	Logic "0" Input bias current	—	—	5		$V_{IN} = 0\text{V}$

Dynamic Electrical Characteristics

$V_{CC} = V_B = 15\text{V}$, $V_S = \text{COM}$, $T_A = 25^\circ\text{C}$, and $C_L = 1000\text{pF}$ unless otherwise specified.

Symbol	Definition	Min.	Typ.	Max.	Units	Test Conditions
t_{ON}	Turn-on propagation delay	—	680	870	ns	$V_S = 0\text{V or }200\text{V}$
t_{OFF}	Turn-off propagation delay	—	150	220		
t_{SD}	Shutdown propagation delay	—	160	220		
t_R	Turn-on rise time	—	70	170		$V_S = 0\text{V}$
t_F	Turn-off fall time	—	30	90		
DT	Deadtime, LS turn-off to HS turn-on & HS turn-on to LS turn-off	400	520	650		
MT	Delay matching time (t_{ON} , t_{OFF})	—	—	60		

Functional Block Diagram

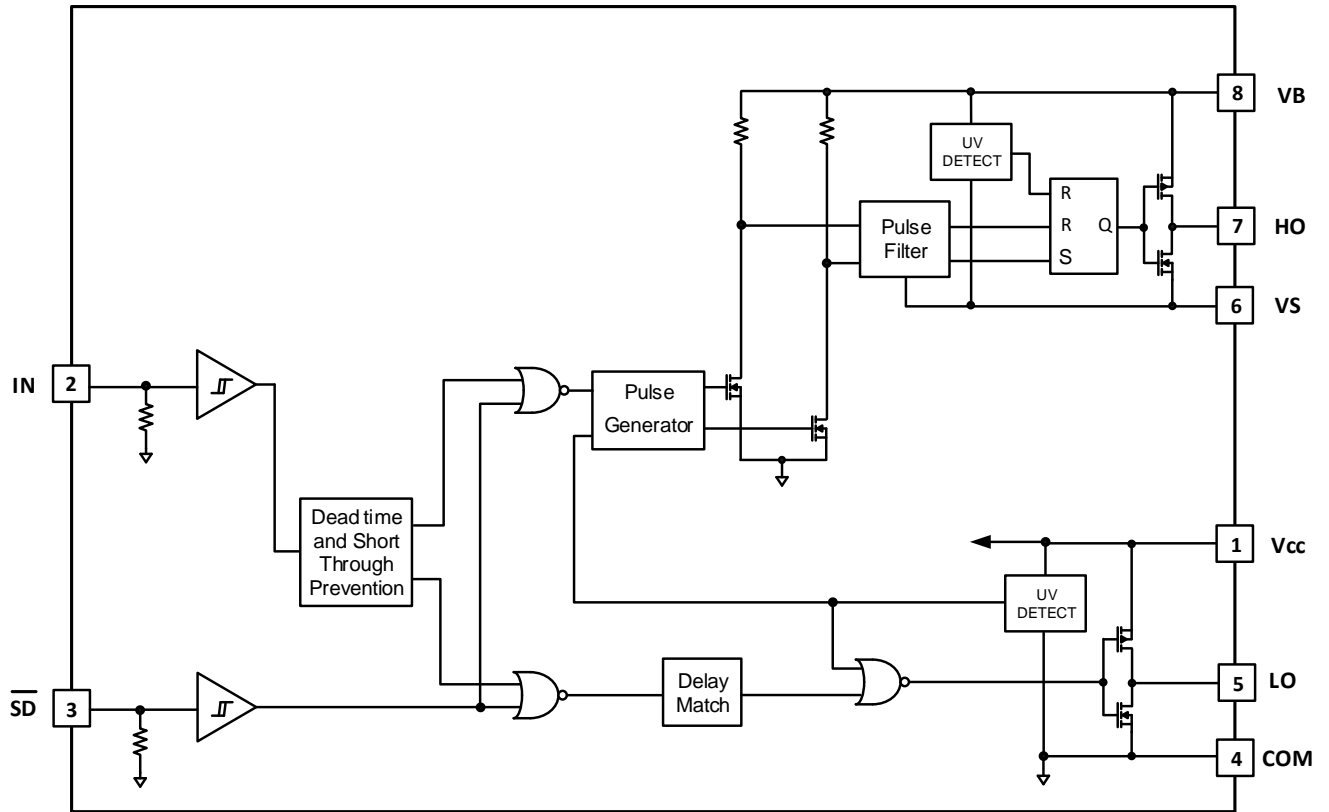

Lead Definitions

Symbol	Description
V _{CC}	Low-side and logic supply voltage
V _B	High-side gate drive floating supply
V _S	High voltage floating supply return
IN	Logic inputs for high and low side gate driver output (HO and LO), in phase with HO
\overline{SD}	Logic inputs for shutdown
HO	High-side driver output
LO	Low-side driver output
COM	Low-side gate drive return

Lead Assignments

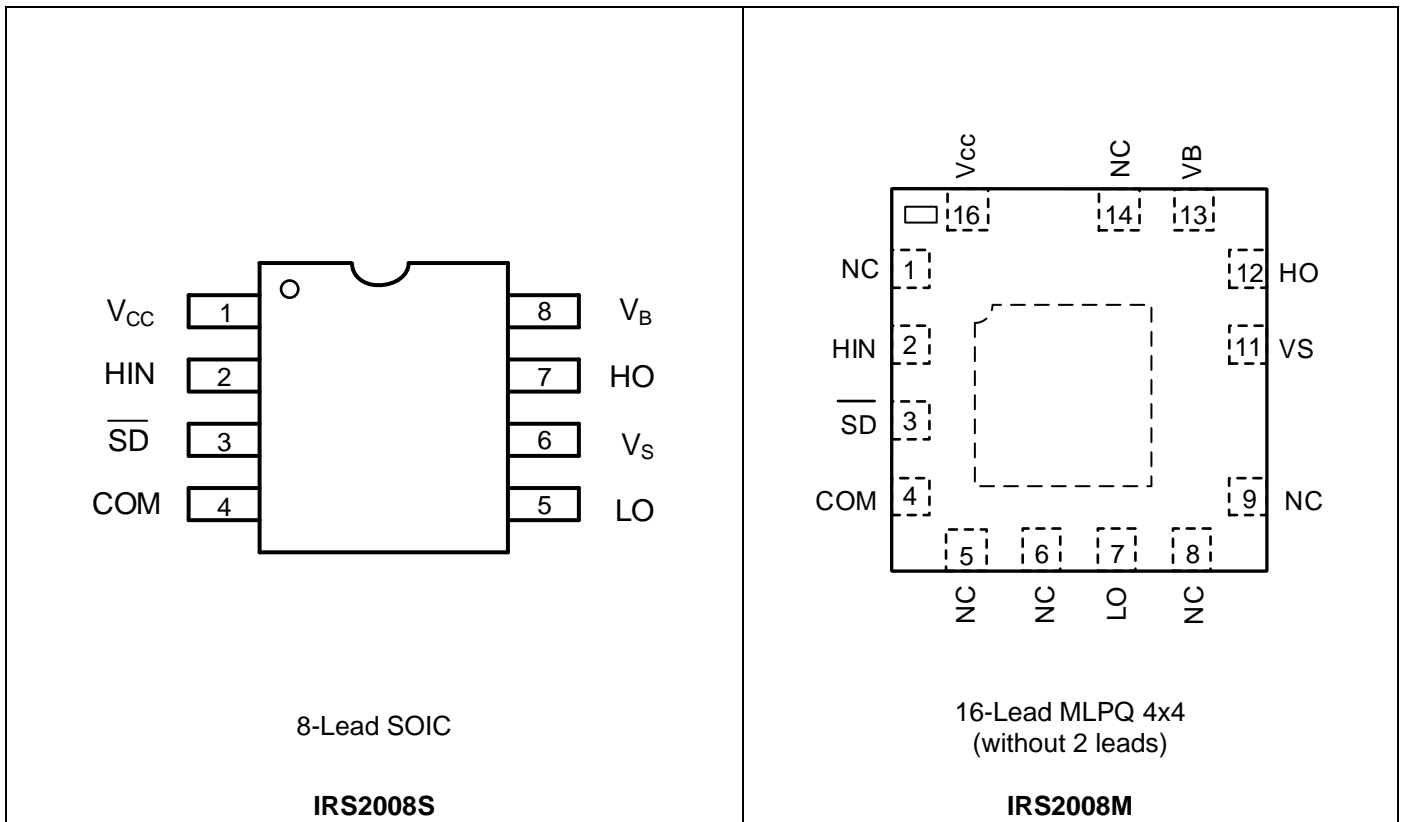

Application Information and Additional Details

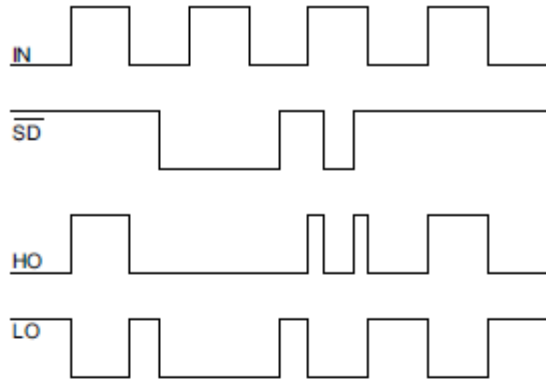

Figure 1. Input/Output Timing Diagram

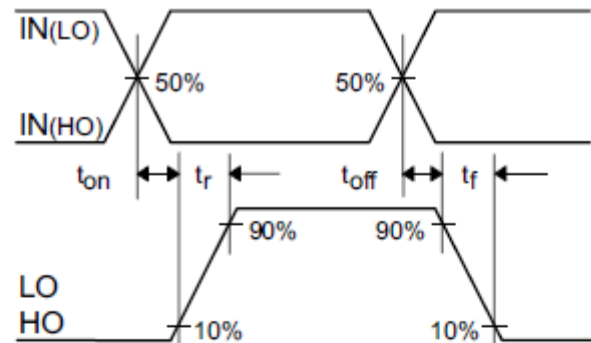

Figure 2. Switching Time Waveform Definitions

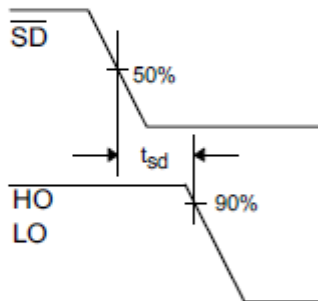

Figure 3. Shutdown Waveform Definitions

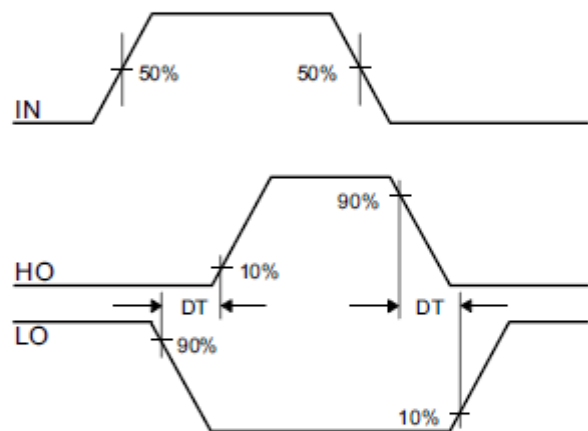

Figure 4. Deadtime Waveform Definitions

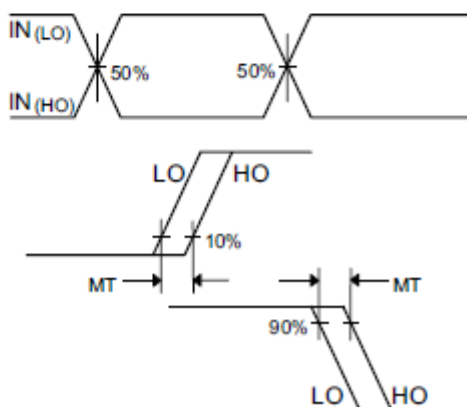

Figure 5. Delay Matching Waveform Definitions

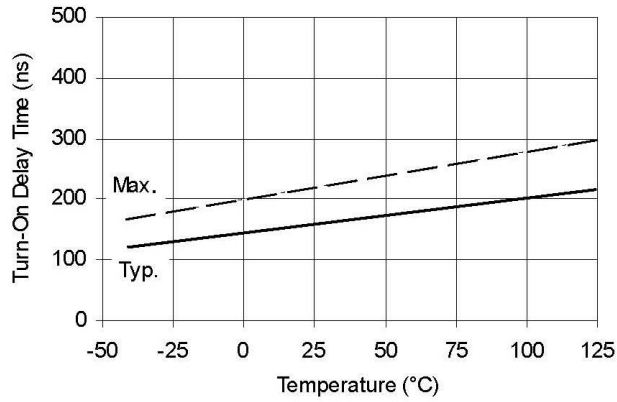

Figure 6A. Turn-On Time vs. Temperature

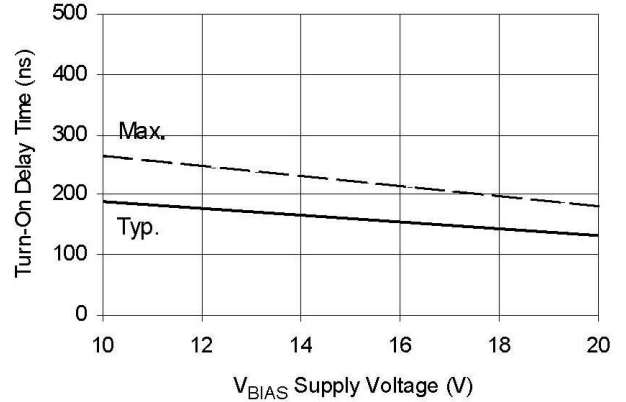

Figure 6B. Turn-On Time vs. Supply Voltage

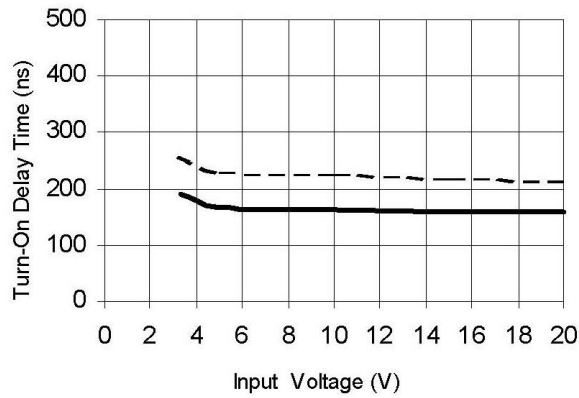

Figure 6C. Turn-On Time vs. Input Voltage

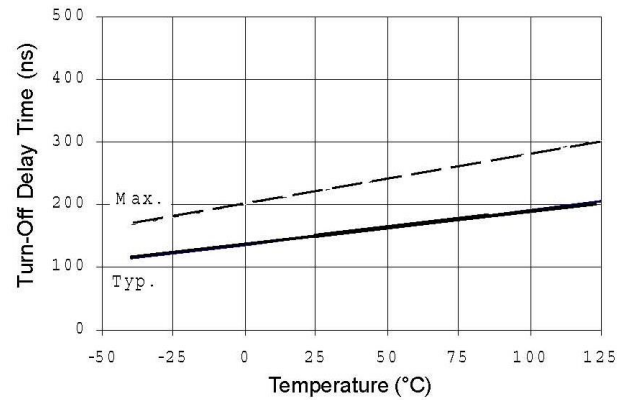

Figure 7A. Turn-Off Time vs. Temperature

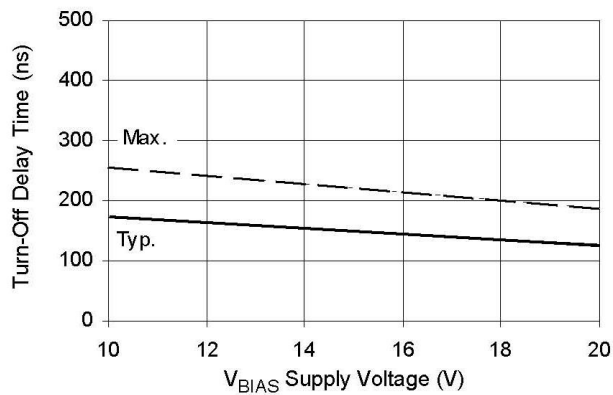

Figure 7B. Turn-Off Time vs. Supply Voltage

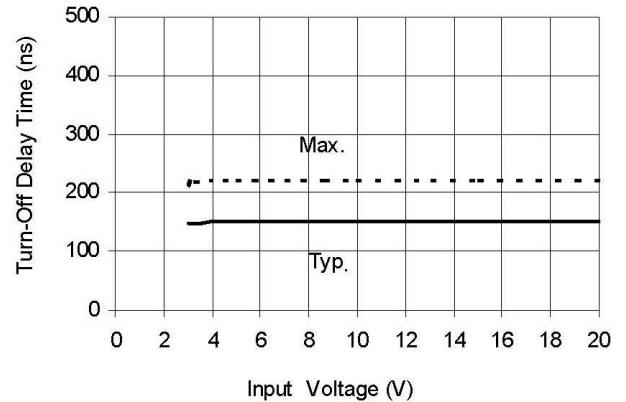

Figure 7C. Turn-Off Time vs. Input Voltage

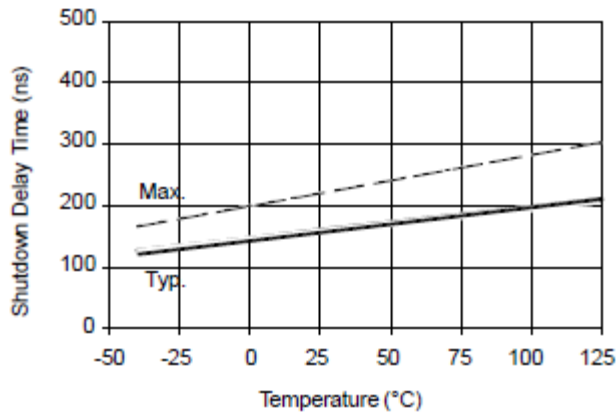

Figure 8A. Shutdown Time vs. Temperature

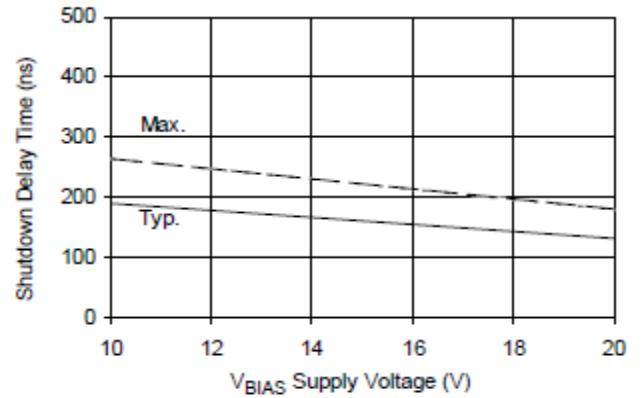

Figure 8B. Shutdown Time vs. Voltage

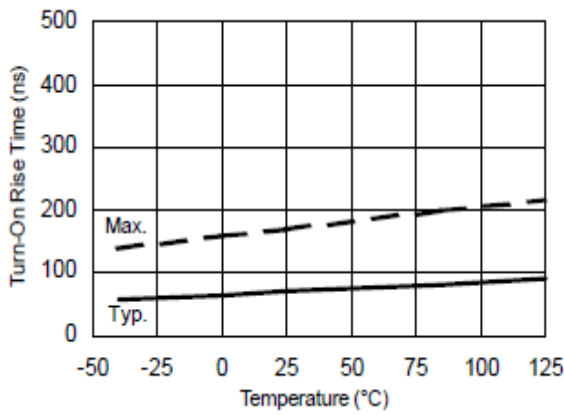

Figure 9A. Turn-On Rise Time vs. Temperature

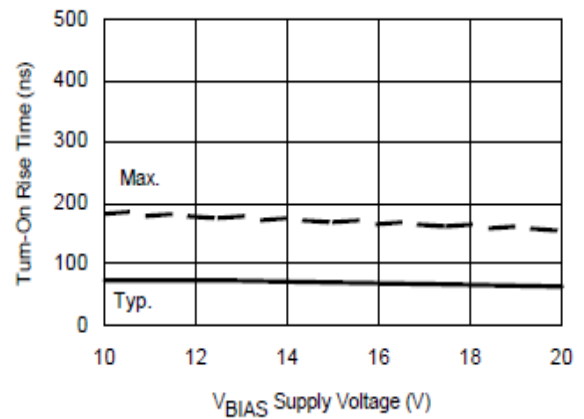

Figure 9B. Turn-On Rise Time vs. Voltage

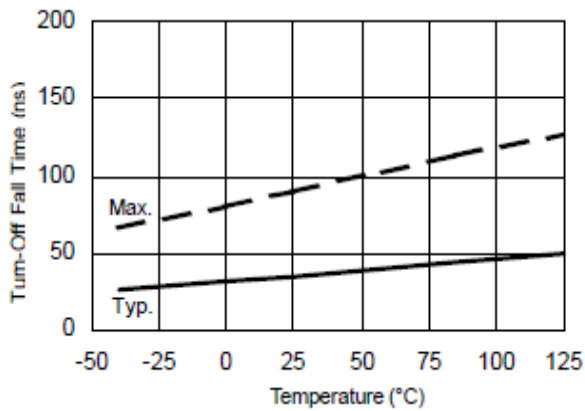

Figure 10A. Turn-Off Fall Time vs. Temperature

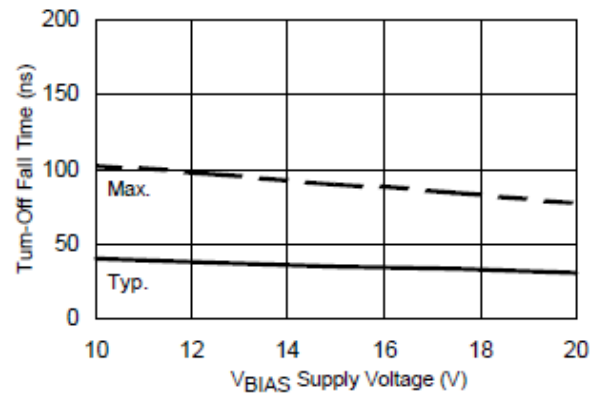

Figure 10B. Turn-Off Fall Time vs. Voltage

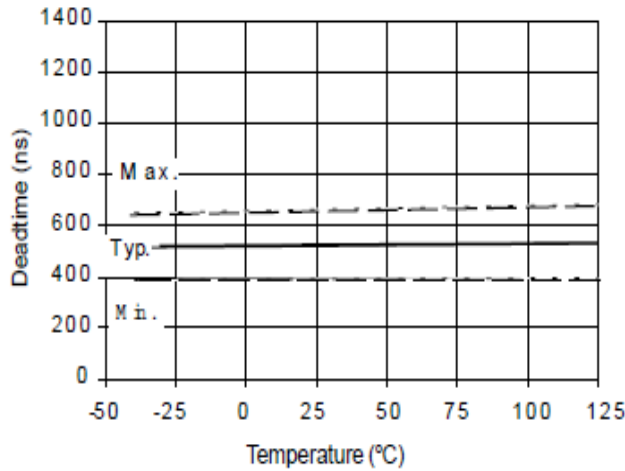

Figure 11A. Deadtime vs. Temperature

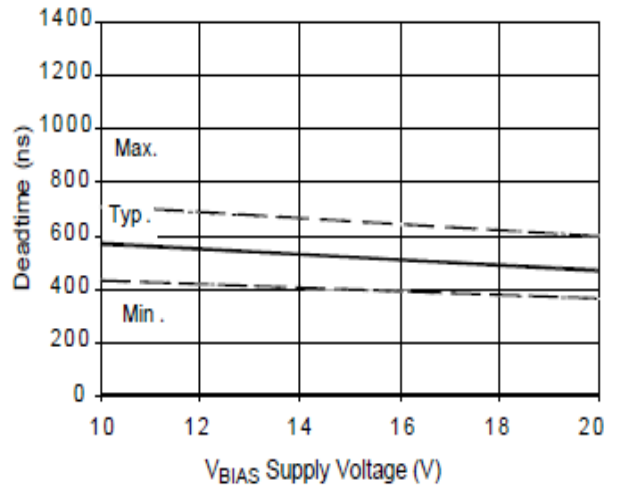

Figure 11B. Deadtime vs. Voltage

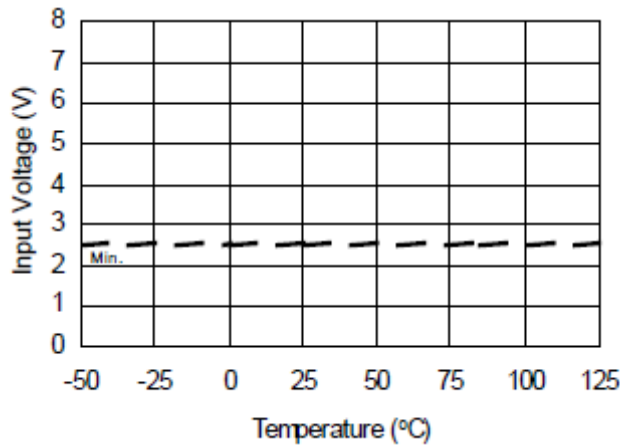

Figure 12A. Logic "1" Input Voltage vs. Temperature

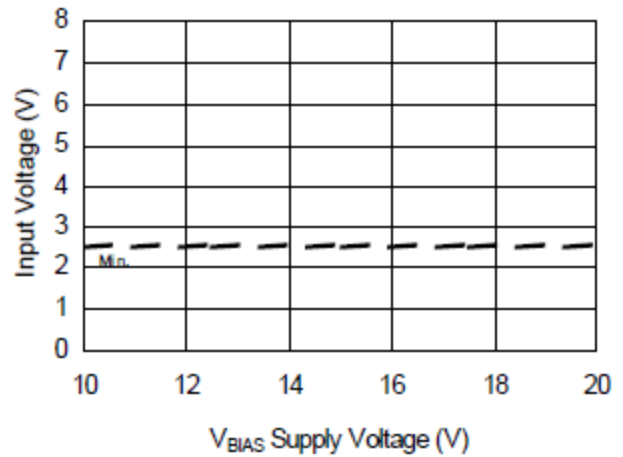

Figure 12B. Logic "1" Input Voltage vs. Voltage

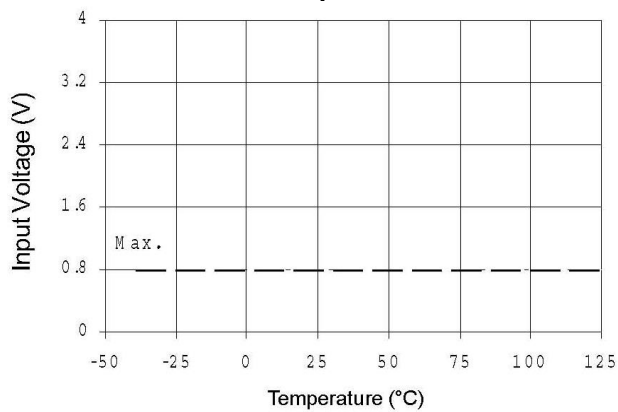

Figure 13A. Logic "0"(HO) & Logic "1"(LO) & Active SD Input Voltages vs. Temperature

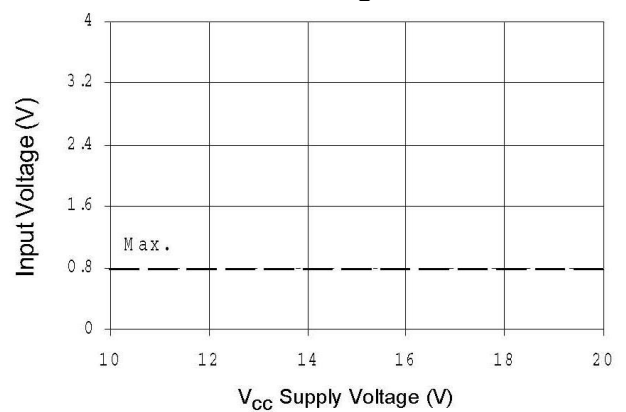

Figure 13B. Logic "0"(HO) & Logic "1"(LO) & Active SD Input Voltages vs. Supply Voltage

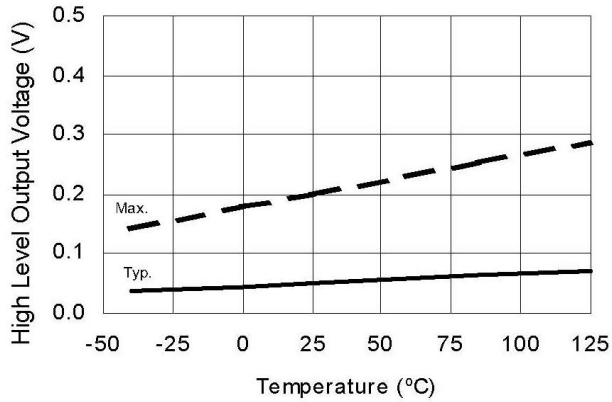

Figure 14A. High Level Output Voltage vs. Temperature

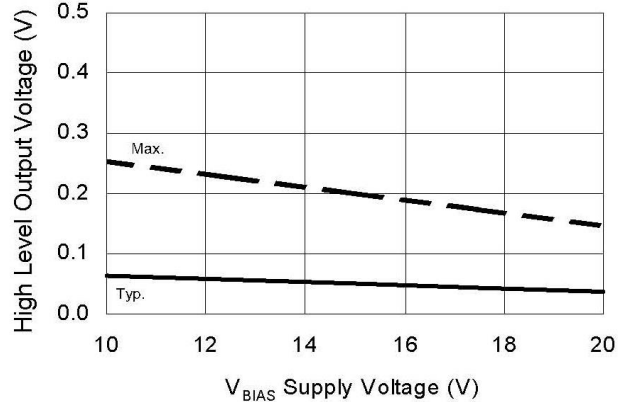

Figure 14B. High Level Output Voltage vs. Supply Voltage

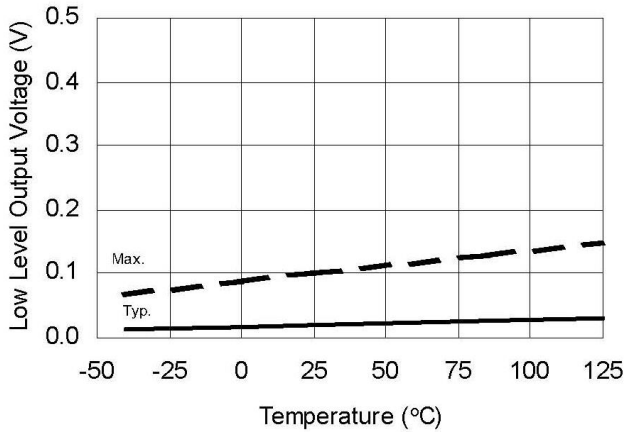

Figure 15A. Low Level Output Voltage vs. Temperature

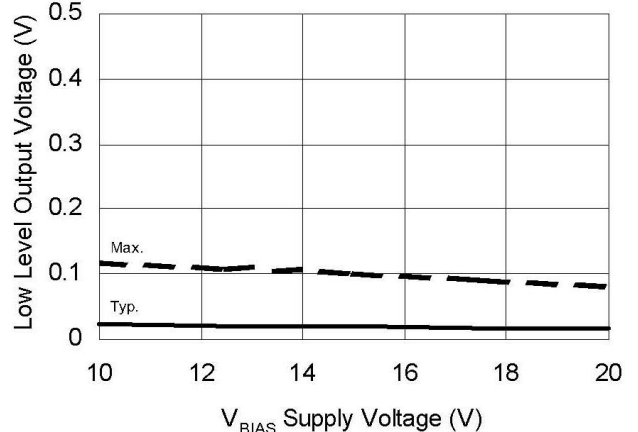

Figure 15B. Low Level Output Voltage vs. Supply Voltage

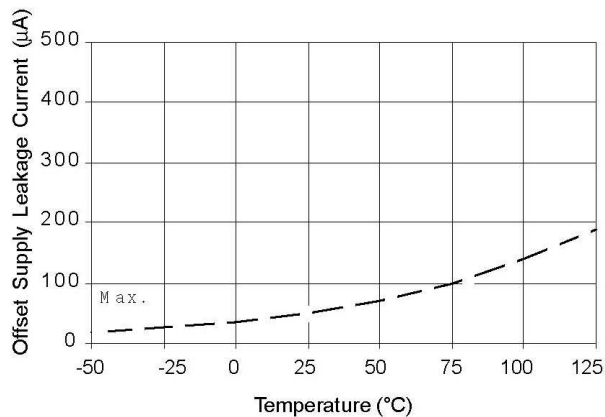

Figure 16A. Offset Supply Current vs. Temperature

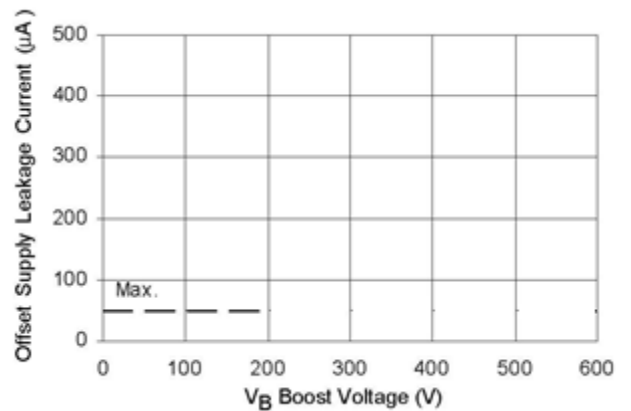

Figure 16B. Offset Supply Current vs. Voltage

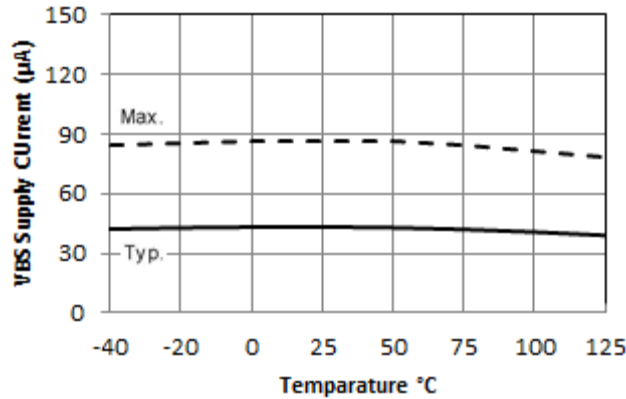

Figure 17A. V_{BS} Supply Current vs. Temperature

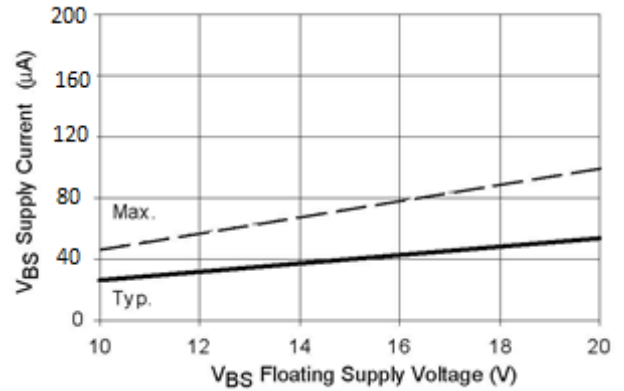

Figure 17B. V_{BS} Supply Current vs. Voltage

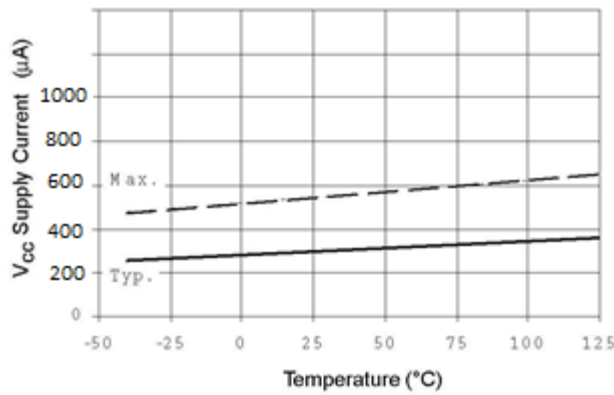

Figure 18A. V_{CC} Supply Current vs. Temperature

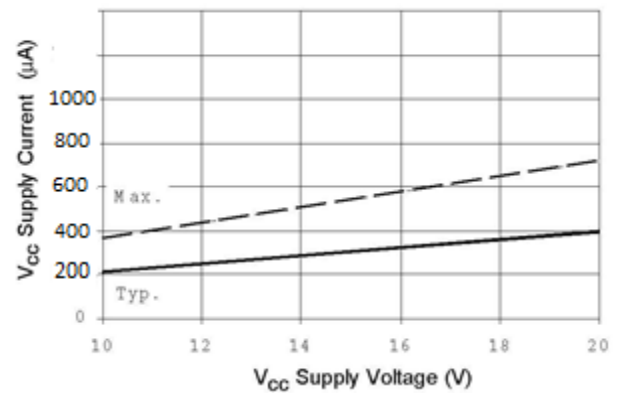

Figure 18B. V_{CC} Supply Current vs. Voltage

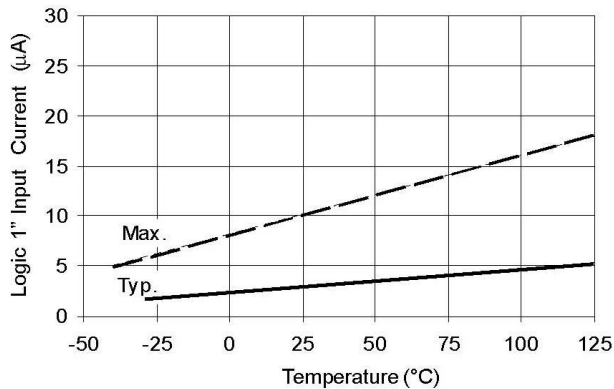

Figure 19A. Logic "1" Input Current vs. Temperature

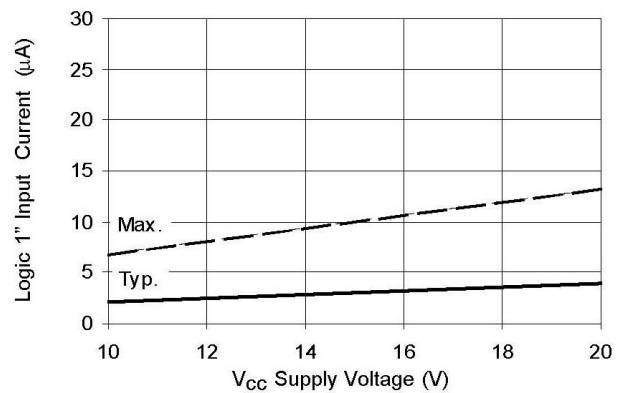

Figure 19B. Logic "1" Input Current vs. Voltage

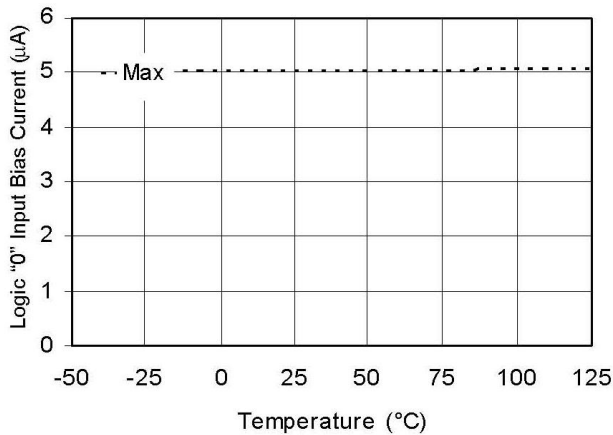

Figure 20A. Logic "0" Input Bias Current

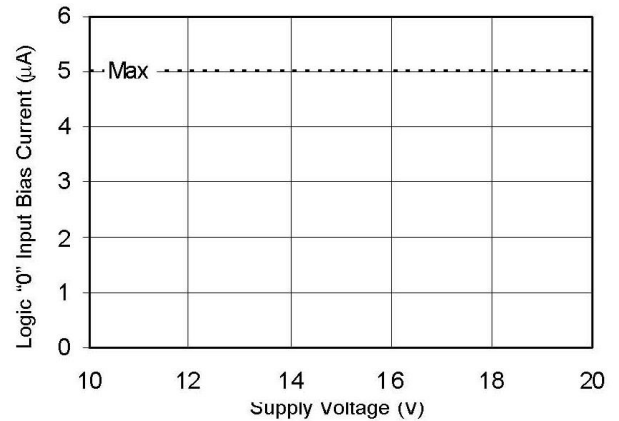

Figure 20B. Logic "0" Input Bias Current

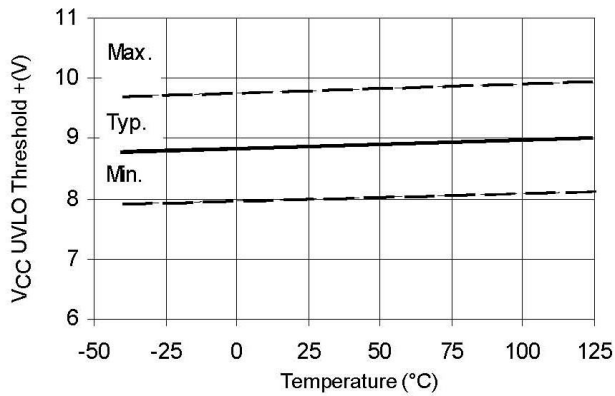

Figure 21A. V_{CC}\V_{BS} Undervoltage Threshold(+) vs. Temperature

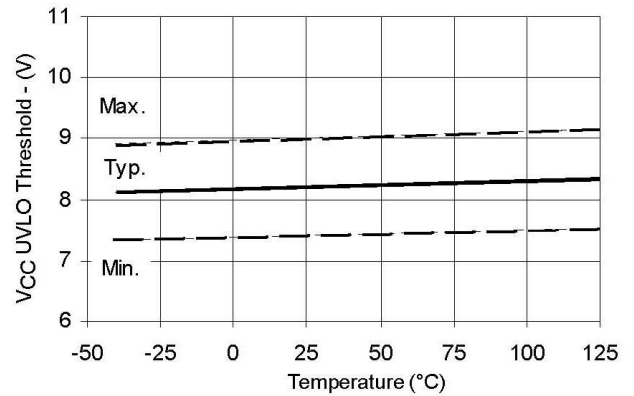

Figure 21B. V_{CC}\V_{BS} Undervoltage Threshold(-) vs. Temperature

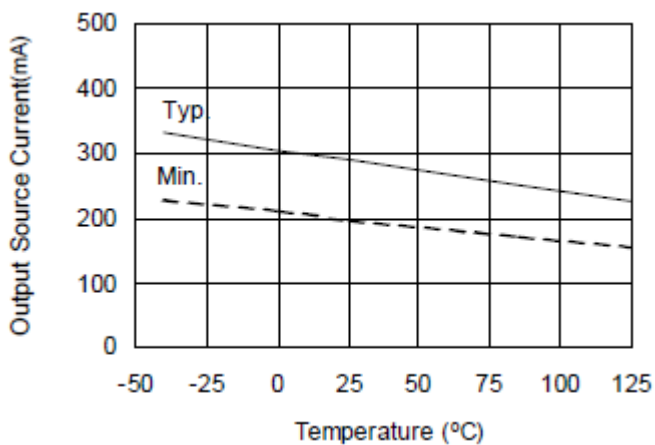

Figure 22A. Output Source Current vs. Temperature

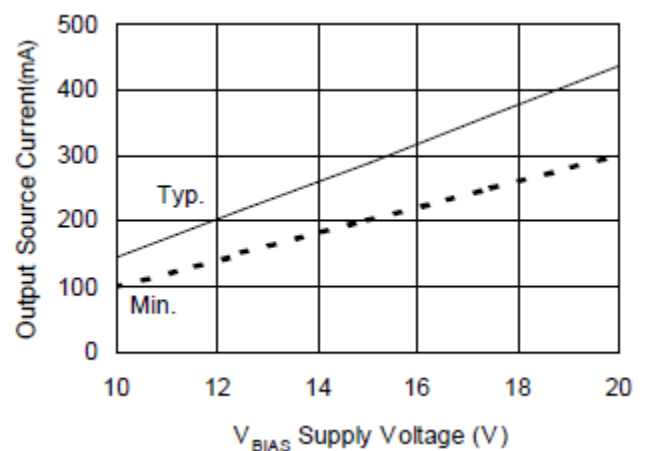

Figure 22B. Output Source Current vs. Supply Current

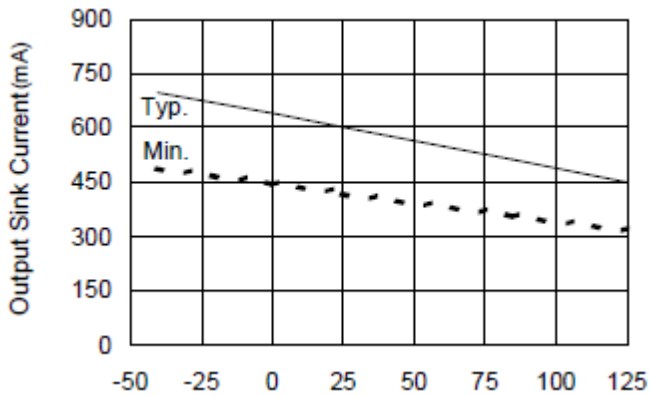

Figure 23A. Output Sink Current vs. Temperature

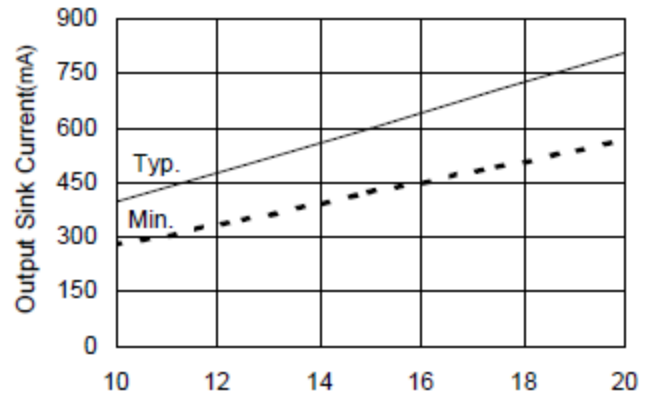

Figure 23B. Output Sink Current vs. Supply Voltage

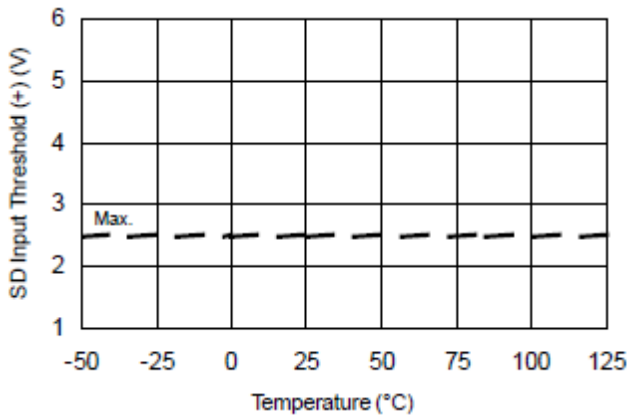

Figure 24A. SD input Positive Going Threshold(+) vs. Temperature

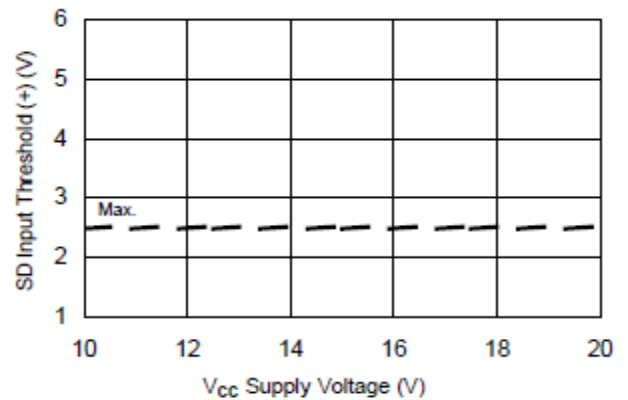

Figure 24B. SD input Positive Going Threshold(+) vs. Supply Voltage

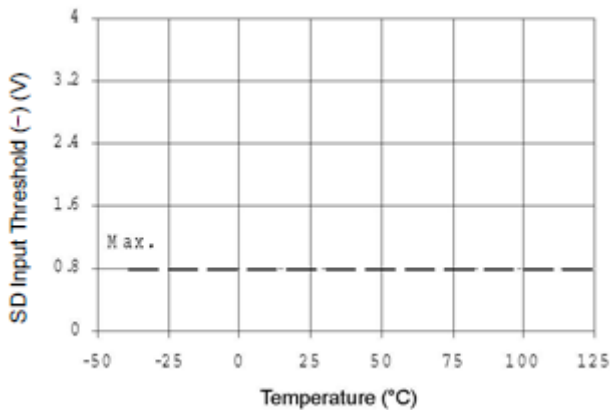

Figure 25A. SD input Negative Going Threshold(-) vs. Temperature

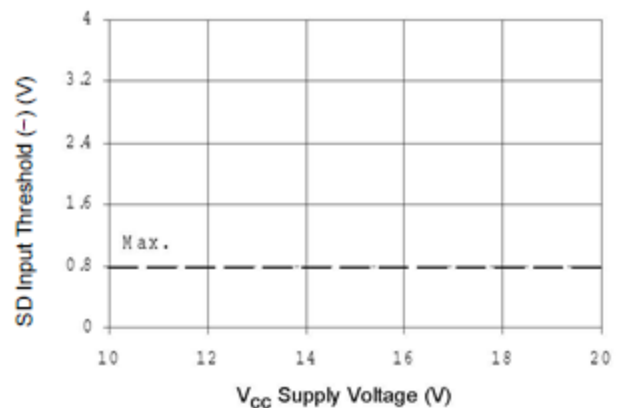
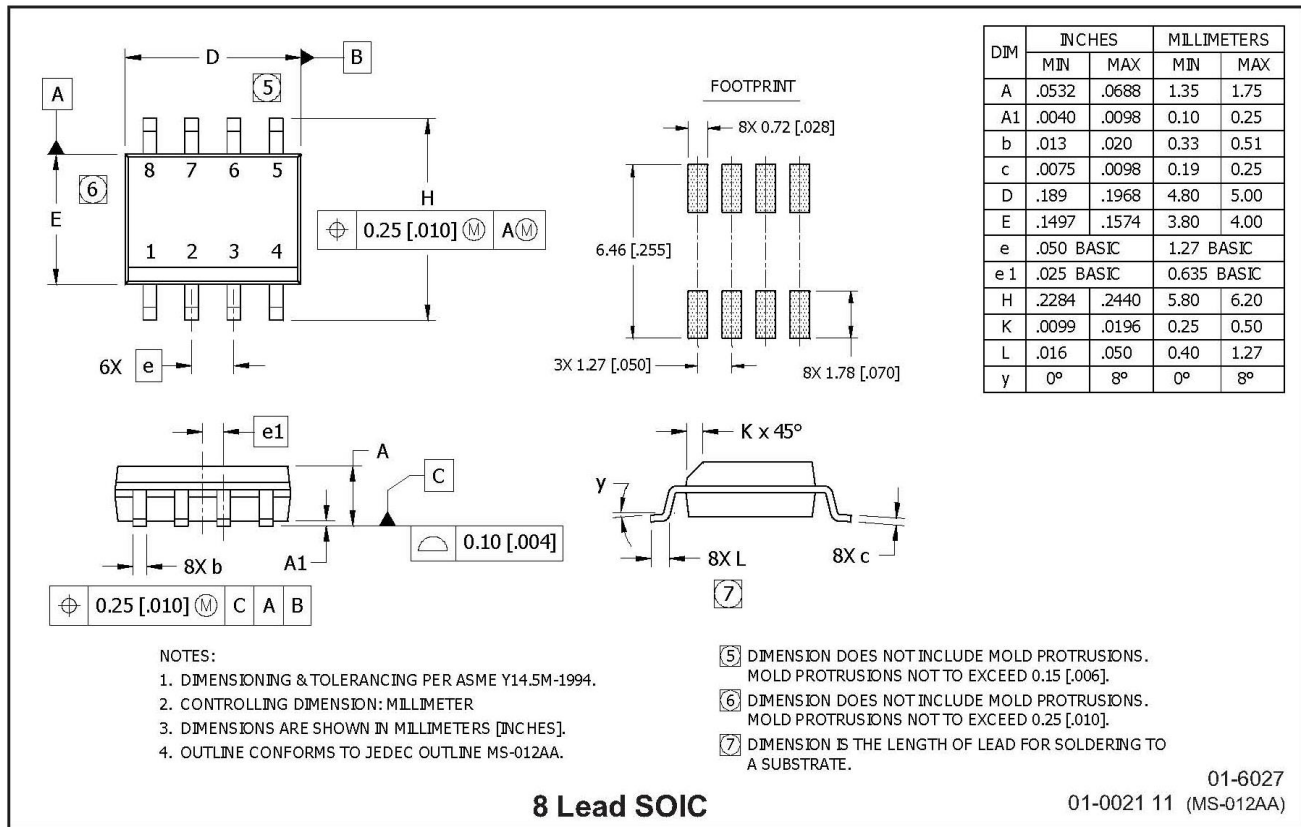
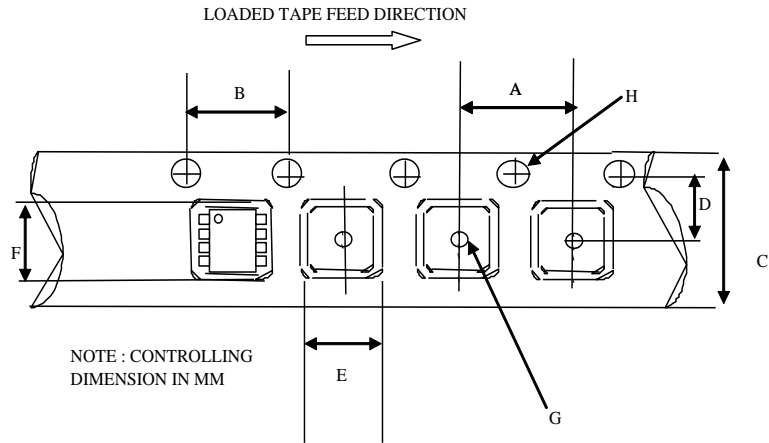

Figure 25B. SD input Negative Going Threshold(-) vs. Voltage

Package Details: 8-Lead SOIC



Tape and Reel Details: 8-Lead SOIC



CARRIER TAPE DIMENSION FOR 8SOICN

Code	Metric		Imperial	
	Min	Max	Min	Max
A	7.90	8.10	0.311	0.318
B	3.90	4.10	0.153	0.161
C	11.70	12.30	0.46	0.484
D	5.45	5.55	0.214	0.218
E	6.30	6.50	0.248	0.255
F	5.10	5.30	0.200	0.208
G	1.50	n/a	0.059	n/a
H	1.50	1.60	0.059	0.062

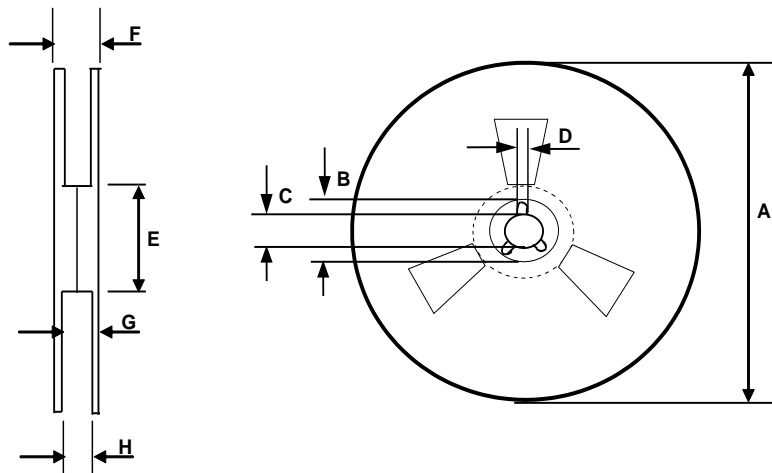

REEL DIMENSIONS FOR 8SOICN

Code	Metric		Imperial	
	Min	Max	Min	Max
A	329.60	330.25	12.976	13.001
B	20.95	21.45	0.824	0.844
C	12.80	13.20	0.503	0.519
D	1.95	2.45	0.767	0.096
E	98.00	102.00	3.858	4.015
F	n/a	18.40	n/a	0.724
G	14.50	17.10	0.570	0.673
H	12.40	14.40	0.488	0.566

Package Details: 14-Lead MLPQ 4x4

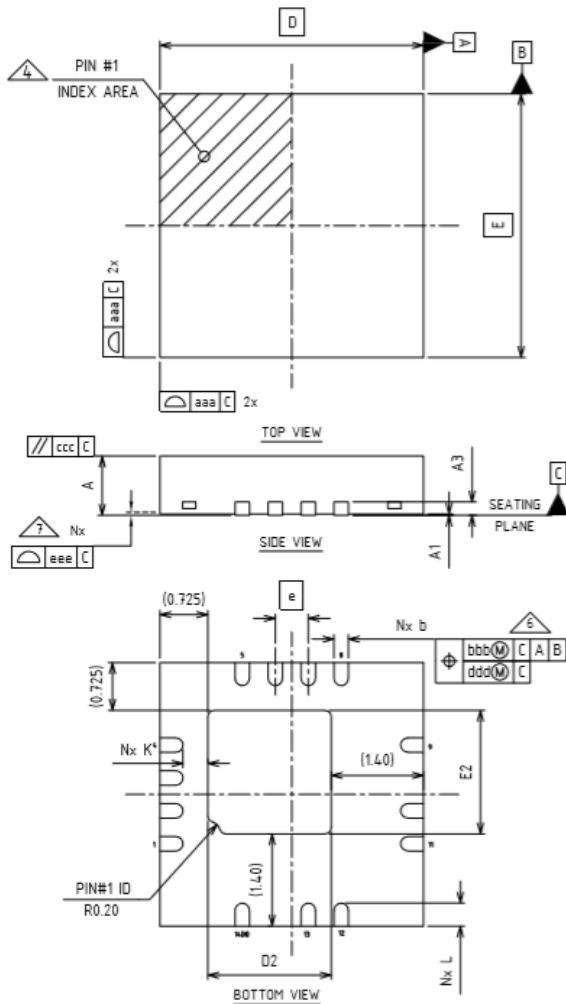

NOTE:

1. Dimensioning and tolerancing conform to ASME Y14.5-2009.
2. All dimensions are in millimeters.
3. N is the total number of terminals.
4. The location of the marked terminal #1 identifier is within the hatched area.
5. ND and NE refer to the number of terminals on each D and E side respectively.
6. Dimension b applies to the metalized terminal and is measured between 0.15mm and 0.30mm from the terminal tip. If the terminal has a radius on the other end of it, dimension b should not be measured in that radius area.
7. Coplanarity applies to the terminals and all other bottom surface metalization.

Dimension Table				
Thickness Symbol	V			NOTE
	MINIMUM	NOMINAL	MAXIMUM	
A	0.80	0.90	1.00	
A1	0.00	0.02	0.05	
A3	---	0.20 Ref	---	
b	0.18	0.25	0.30	6
D	4.00 BSC			
E	4.00 BSC			
e	0.50 BSC			
D2	1.725	1.875	1.975	
E2	1.725	1.875	1.975	
K	0.20	---	---	
L	0.25	0.35	0.45	
aaa	0.05			
bbb	0.10			
ccc	0.10			
ddd	0.05			
eee	0.08			
N	14			3
ND	SEE FIGURE			5
NE	SEE FIGURE			
NOTES	1, 2			

Tape and Reel Details: 14-Lead MLPQ 4x4

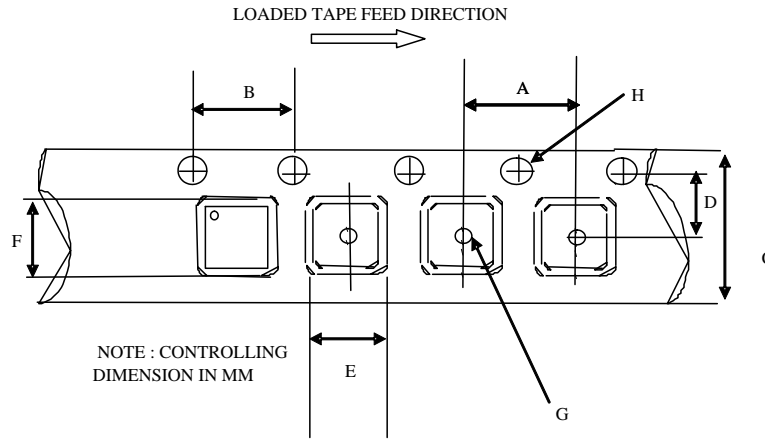

CARRIER TAPE DIMENSION FOR MLPQ4x4

Code	Metric		Imperial	
	Min	Max	Min	Max
A	7.90	8.10	0.311	0.358
B	3.90	4.10	0.153	0.161
C	11.70	12.30	0.461	0.484
D	5.45	5.55	0.215	0.219
E	4.25	4.45	0.168	0.176
F	4.25	4.45	0.168	0.176
G	1.50	n/a	0.069	n/a
H	1.50	1.60	0.069	0.063

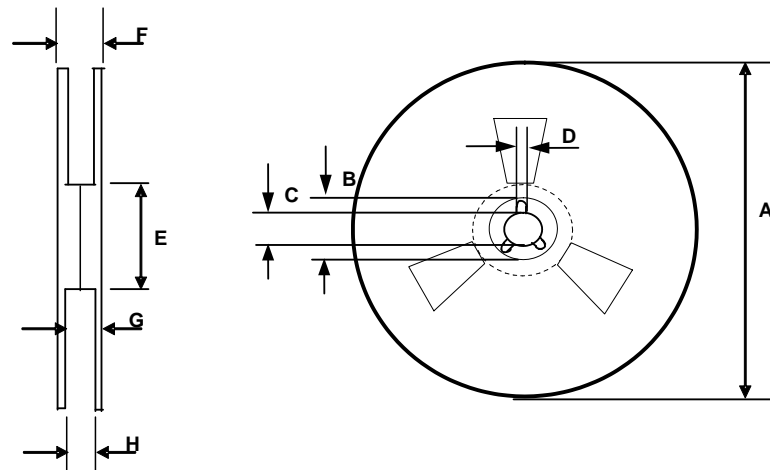

REEL DIMENSIONS FOR MLPQ4x4

Code	Metric		Imperial	
	Min	Max	Min	Max
A	329.60	330.25	12.976	13.001
B	20.95	21.45	0.824	0.844
C	12.80	13.20	0.503	0.519
D	1.95	2.45	0.767	0.096
E	98.00	102.00	3.858	4.015
F	n/a	18.40	n/a	0.724
G	14.50	17.10	0.570	0.673
H	12.40	14.40	0.488	0.566

Part Marking Information

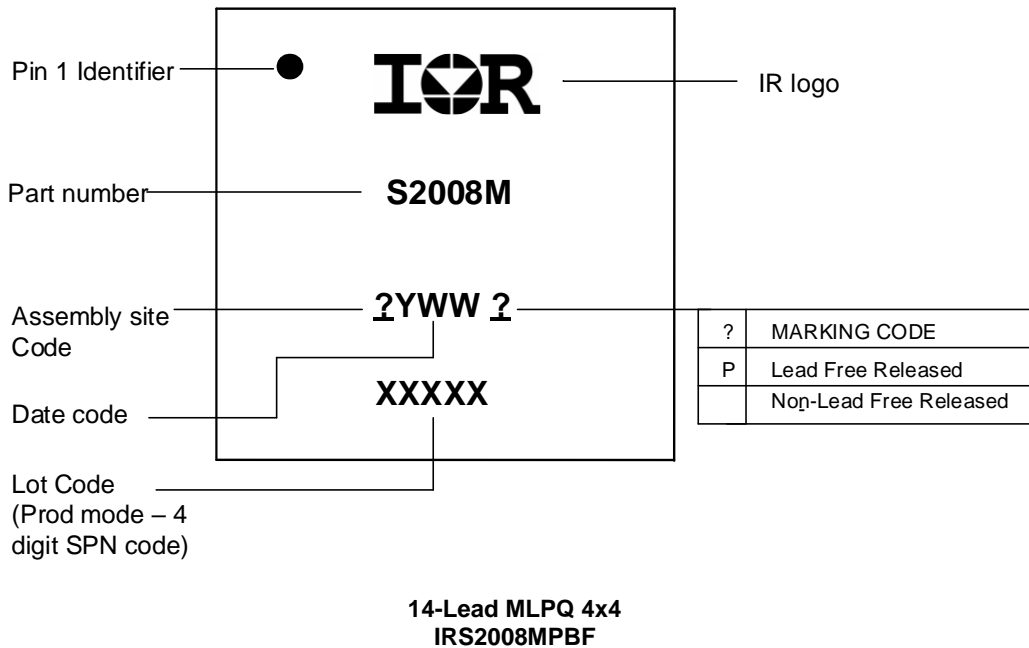
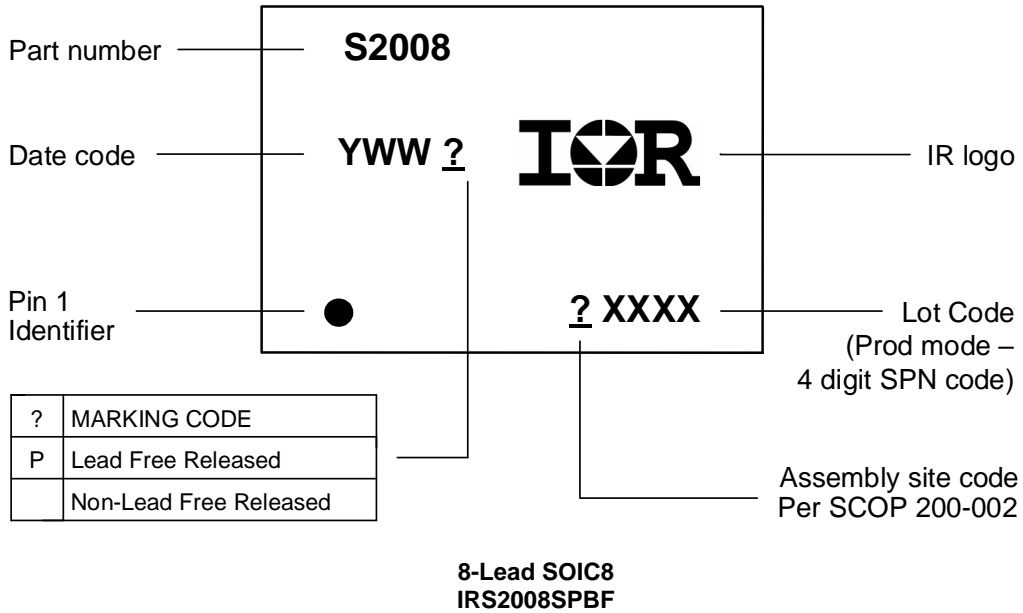

Qualification Information†

Qualification Level		Industrial†	
		Comments: This family of ICs is qualified according to relevant tests of JEDEC47/22/20. IR's Consumer qualification level is granted by extension of the higher Industrial level.	
Moisture Sensitivity Level		8 Lead SOIC	MSL2††, 260°C (per IPC/JEDEC J-STD-020)
		14-Lead MLPQ 4x4	
ESD	Human Body Model	Class 2 (per JEDEC standard JESD22-A114)	
	Machine Model	Class A (per EIA/JEDEC standard EIA/JESD22-A115)	
IC Latch-Up Test		Class I (per JESD78)	
RoHS Compliant		Yes	

† According to IR Qualification Requirements for IC products.

†† Higher MSL ratings may be available for the specific package types listed here. Please contact your Infineon sales representative for further information.

Published by
Infineon Technologies AG
81726 München, Germany
© Infineon Technologies AG 2020
All Rights Reserved.

IMPORTANT NOTICE

The information given in this document shall in no event be regarded as a guarantee of conditions or characteristics (“Beschaffenheitsgarantie”). With respect to any examples, hints or any typical values stated herein and/or any information regarding the application of the product, Infineon Technologies hereby disclaims any and all warranties and liabilities of any kind, including without limitation warranties of non-infringement of intellectual property rights of any third party.

In addition, any information given in this document is subject to customer’s compliance with its obligations stated in this document and any applicable legal requirements, norms and standards concerning customer’s products and any use of the product of Infineon Technologies in customer’s applications.

The data contained in this document is exclusively intended for technically trained staff. It is the responsibility of customer’s technical departments to evaluate the suitability of the product for the intended application and the completeness of the product information given in this document with respect to such application.

For further information on the product, technology, delivery terms and conditions and prices please contact your nearest Infineon Technologies office (www.infineon.com).

WARNINGS

Due to technical requirements products may contain dangerous substances. For information on the types in question please contact your nearest Infineon Technologies office.

Except as otherwise explicitly approved by Infineon Technologies in a written document signed by authorized representatives of Infineon Technologies, Infineon Technologies’ products may not be used in any applications where a failure of the product or any consequences of the use thereof can reasonably be expected to result in personal injury.