

**MAX38640–MAX38643**
**Tiny 1.8V to 5.5V Input, 330nA I<sub>Q</sub>, 700mA  
nanoPower Buck Converter**

### General Description

The MAX38640–MAX38643 are a nanoPower family of ultra-low 330nA quiescent current buck (step-down) DC-DC converters that operate from 1.8V to 5.5V input voltage and support load currents of up to 175mA, 350mA, 700mA with peak efficiencies of 96%. While in shutdown, there is only 5nA of shutdown current. The devices offer ultra-low quiescent current, small total solution size, and high efficiency throughout the load range. The MAX38640–MAX38643 are ideal for battery applications where long battery life is a must.

The MAX38640–MAX38643 family utilizes a unique control scheme that allows ultra-low quiescent current and high efficiency over a wide output current range. The MAX38642 excludes active discharge resistor in shutdown, which allows the output to be regulated or held high by another source or by the charged output capacitor.

The MAX38640–MAX38643 devices are offered in a space-saving 1.42mm x 0.89mm, 6-pin WLP (2x3 bump, 0.4mm pitch), as well as a 2mm x 2mm, 6-pin  $\mu$ DFN package. All parts are specified over the -40°C to +85°C extended temperature range.

### Applications

- Portable, Space-Constrained Consumer Products
- Wearable Devices, Ultra-Low-Power IoT, NB IoT, and Bluetooth<sup>®</sup> LE
- Single Li-ion (Li+) and Coin Cell Battery Products
- Wired or Wireless Industrial Products

### Benefits and Features

- Extends Battery Life
  - 330nA Ultra-Low Quiescent Supply Current
  - 5nA Shutdown Current
  - 96% Peak Efficiency and over 88% at 10 $\mu$ A
- Easy to Use – Addresses Popular Operation
  - 1.8V to 5.5V Input Range
  - Single Resistor-Adjustable V<sub>OUT</sub> from 0.7V to 3.3V (A-Option)
  - Preprogrammed V<sub>OUT</sub> from 0.5V to 5.0V (B-Option)
  - $\pm$ 1.75% Output Voltage Accuracy
  - Up to 175mA/350mA/700mA Load Current
- Protects System in Multiple Use Cases
  - Reverse-Current Blocking in Shutdown
  - Optional Active Discharge Feature
- Reduces Size and Increases Reliability
  - -40°C to +85°C Temperature Range
  - 2mm x 2mm, 6-pin  $\mu$ DFN Package
  - 1.42mm x 0.89mm, 0.4mm Pitch 6-pin (2 x 3) WLP

### Typical Operating Circuit

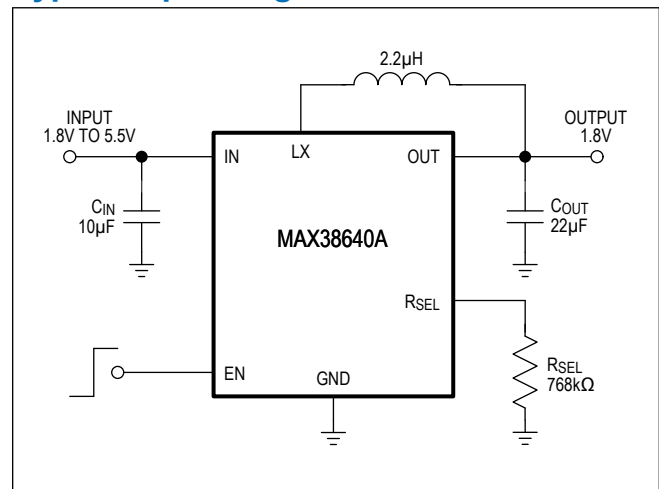

Bluetooth is a registered trademark of Bluetooth SIG, Inc.

[Ordering Information](#) appears at end of data sheet.

19-100410; Rev 11; 8/24

© 2024 Analog Devices, Inc. All rights reserved. Trademarks and registered trademarks are the property of their respective owners.

One Analog Way, Wilmington, MA 01887 U.S.A. | Tel: 781.329.4700 | © 2024 Analog Devices, Inc. All rights reserved.

---

**TABLE OF CONTENTS**

---

General Description . . . . .	1
Applications . . . . .	1
Benefits and Features . . . . .	1
Typical Operating Circuit . . . . .	1
Absolute Maximum Ratings . . . . .	5
Package Information . . . . .	5
6 $\mu$ DFN . . . . .	5
6 WLP . . . . .	5
Electrical Characteristics . . . . .	6
Typical Operating Characteristics . . . . .	8
Pin Configurations . . . . .	11
6 $\mu$ DFN . . . . .	11
6 WLP . . . . .	12
Pin Descriptions . . . . .	12
Functional Diagram . . . . .	13
Detailed Description . . . . .	14
Voltage Configuration . . . . .	14
Applications Information . . . . .	16
Inductor Selection . . . . .	16
Input Capacitor . . . . .	16
Output Capacitor . . . . .	16
Enabling Device . . . . .	16
PCB Layout and Routing . . . . .	17
Ordering Information . . . . .	18
Revision History . . . . .	19

---

**LIST OF FIGURES**

---

Figure 1. RC Circuit at EN. . . . . 16

**LIST OF TABLES**

---

Table 1. MAX38640A/1A/2A/3A  $R_{SEL}$  Selection Table ..... 14  
Table 2. Inductor Selection ..... 16

### Absolute Maximum Ratings

IN, EN, R <sub>SEL</sub> , NC, OUT to GND.....	-0.3V to +6V	Continuous Power Dissipation— $\mu$ DFN (T <sub>A</sub> = +70°C) (Derate 4.5mW/°C above +70°C) .....	357.8mW
LX RMS Current WLP .....	-1.6A <sub>RMS</sub> to +1.6A <sub>RMS</sub>	Operating Temperature Range .....	-40°C to +85°C
LX RMS Current $\mu$ DFN.....	-1A <sub>RMS</sub> to +1A <sub>RMS</sub>	Maximum Junction Temperature .....	+150°C
LX to GND ( <i>Note 1</i> ) .....	-0.3V to V <sub>IN</sub> + 0.3V	Storage Temperature Range .....	-65°C to +150°C
Continuous Power Dissipation—WLP (T <sub>A</sub> = +70°C) (Derate 10.5mW/°C above +70°C).....	840mW	Lead Temperature (soldering, 10 seconds) .....	+300°C
		Soldering Temperature (reflow) .....	+260°C

**Note 1:** LX pin has internal clamps to GND and IN. These diodes may be forward biased during switching transitions. During these transitions, the max LX current should be within the Max RMS Current rating for safe operation.

*Stresses beyond those listed under "Absolute Maximum Ratings" may cause permanent damage to the device. These are stress ratings only, and functional operation of the device at these or any other conditions beyond those indicated in the operational sections of the specifications is not implied. Exposure to absolute maximum rating conditions for extended periods may affect device reliability.*

### Package Information

#### 6 $\mu$ DFN

Package Code	L622+1C
Outline Number	<a href="#">21-0164</a>
Land Pattern Number	<a href="#">90-0004</a>
<b>Thermal Resistance, Four-Layer Board:</b>	
Junction to Ambient ( $\theta_{JA}$ )	223.6°C/W
Junction to Case ( $\theta_{JC}$ )	122°C/W

#### 6 WLP

Package Code	N60E1+2
Outline Number	<a href="#">21-100128</a>
Land Pattern Number	Refer to <a href="#">Application Note 1891</a>
<b>Thermal Resistance, Four-Layer Board:</b>	
Junction to Ambient ( $\theta_{JA}$ )	95.15°C/W

For the latest package outline information and land patterns (footprints), go to [www.maximintegrated.com/packages](http://www.maximintegrated.com/packages). Note that a "+", "#", or "-" in the package code indicates RoHS status only. Package drawings may show a different suffix character, but the drawing pertains to the package regardless of RoHS status.

Package thermal resistances were obtained using the method described in JEDEC specification JESD51-7, using a four-layer board. For detailed information on package thermal considerations, refer to [www.maximintegrated.com/thermal-tutorial](http://www.maximintegrated.com/thermal-tutorial).

## Electrical Characteristics

(V<sub>IN</sub> = 3.3V, V<sub>OUT</sub> = 1.8V, T<sub>A</sub> = -40°C to +85°C, C<sub>IN</sub> = 10μF, C<sub>OUT</sub> = 22μF, unless otherwise specified. ([Note 2](#)))

PARAMETER	SYMBOL	CONDITIONS		MIN	TYP	MAX	UNITS
Shutdown Current	I <sub>IN_SD</sub>	V <sub>EN</sub> = 0V, T <sub>A</sub> = +25°C			0.005	0.1	μA
Input Voltage Range	V <sub>IN_RANGE</sub>	Guaranteed by output accuracy		1.8		5.5	V
Input Undervoltage Lockout	V <sub>UVLO</sub>	R <sub>SEL</sub> > 50kΩ (MAX38640A/1A/ 2A/3A), (MAX38640B/1B/ 2B/3B)	V <sub>IN</sub> rising		1.75	1.8	V
			Hysteresis		50		mV
	V <sub>UVLO</sub>	R <sub>SEL</sub> < 50kΩ (MAX38640A/1A/ 2A/3A)	V <sub>IN</sub> rising		2.6	2.7	V
			Hysteresis		125		mV
Output Voltage Range	V <sub>OUT_RANGE</sub>	Guaranteed by output accuracy		0.5		5	V
Output Accuracy	V <sub>OUT_ACC</sub>	OUT falling, when LX begins switching above 1MHz, V <sub>OUT</sub> = 0.7V to 3.3V, V <sub>IN</sub> = 5.5V ( <a href="#">Note 3</a> )		-1.75		+1.75	%
DC Line Regulation	V <sub>LREG</sub>	V <sub>OUT</sub> = 1.8V, V <sub>IN</sub> = 2.0V to 5.5V, I <sub>OUT</sub> = 10mA to 160mA			±1.5		%
Quiescent Supply Current into IN	I <sub>Q_IN</sub>	V <sub>EN</sub> = V <sub>IN</sub> , not switching V <sub>OUT</sub> = 106% of target voltage, V <sub>OUT TARGET</sub> = 2.5V, T <sub>A</sub> = +25°C			330	660	nA
Quiescent Supply Current into OUT	I <sub>Q_OUT</sub>	V <sub>EN</sub> = V <sub>IN</sub> , not switching V <sub>OUT</sub> = 106% of target voltage, V <sub>OUT TARGET</sub> = 2.5V, T <sub>A</sub> = +25°C			10		nA
Soft-Start Slew Rate	dV <sub>OUT</sub> /dt	V <sub>OUT</sub> = 1.8V, no load			6.5		mV/μs
LX Leakage Current	I <sub>LEAK_LX</sub>	V <sub>LX</sub> = V <sub>IN</sub> = 5.5V, T <sub>A</sub> = +25°C			2	100	nA
Inductor Peak Current Limit	I <sub>PEAK_LX</sub>	MAX38643		800	1000	1200	mA
		MAX38641/MAX38642		400	500	600	
		MAX38640		225	250	300	
High-Side R <sub>DS(on)</sub>	R <sub>DS_H</sub>	V <sub>IN</sub> = 3.3V	MAX38643		95	150	mΩ
			MAX38641/ MAX38642		170	320	
			MAX38640		320	600	
Low-Side R <sub>DS(on)</sub>	R <sub>DS_L</sub>	V <sub>IN</sub> = 3.3V	MAX38643		50	90	mΩ
			MAX38641/ MAX38642		80	160	
			MAX38640		150	290	
Zero-Crossing Threshold	I <sub>ZX_LX</sub>	V <sub>OUT</sub> = 1.2V, percent of I <sub>PEAK_LX</sub>			5		%
Enable Input Leakage	I <sub>LEAK_EN</sub>	V <sub>EN</sub> = 5.5V, T <sub>A</sub> = +25°C			0.1	100	nA
Enable Voltage Threshold	V <sub>EN_R</sub>	V <sub>EN</sub> rising			0.8	1.2	V
	V <sub>EN_F</sub>	V <sub>EN</sub> falling		0.4	0.7		
Active Discharge Resistance (MAX38640/1/3 Only)	R <sub>OUT_DIS</sub>	V <sub>EN</sub> = 0V		50	85	200	Ω

**Electrical Characteristics (continued)**(V<sub>IN</sub> = 3.3V, V<sub>OUT</sub> = 1.8V, T<sub>A</sub> = -40°C to +85°C, C<sub>IN</sub> = 10μF, C<sub>OUT</sub> = 22μF, unless otherwise specified. ([Note 2](#)))

PARAMETER	SYMBOL	CONDITIONS	MIN	TYP	MAX	UNITS
Required Select Resistor Accuracy (MAX38640A/1A/2A/3A Only)	R <sub>SEL</sub>	Use the nearest ±1% resistor from <a href="#">Table 1</a>	-1		+1	%
Select Resistor Detection Time (MAX38640A/1A/2A/3A Only)	t <sub>RSEL</sub>	C <sub>SEL</sub> < 2pF	240	600	1320	μs
Thermal Shutdown	T <sub>SHUT</sub>	T <sub>J</sub> rising when output turns off		165		°C
Thermal Shutdown Threshold	T <sub>SHUT</sub>	T <sub>J</sub> falling when output turns on		150		°C

**Note 2:** Limits over the specified operating temperature and supply voltage range are guaranteed by design and characterization, and production tested at room temperature only.**Note 3:** Output Accuracy in low-power mode (LPM) and does not include load, line, or ripple.

Typical Operating Characteristics

(MAX38640AENT+, V<sub>IN</sub> = 3.6V, V<sub>OUT</sub> = 1.8V, L = 2.2μH, C<sub>IN</sub> = 10μF, C<sub>OUT</sub> = 22μF, T<sub>A</sub> = +25°C, unless otherwise noted.)

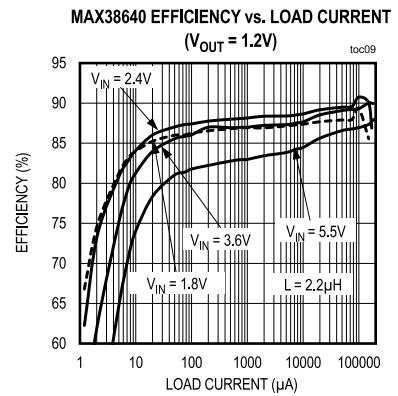
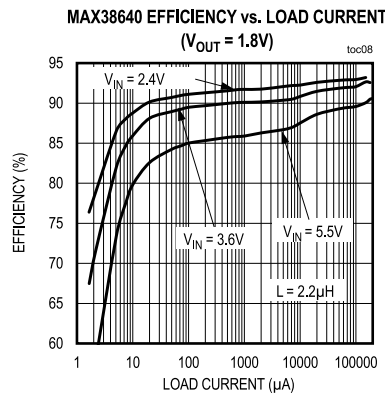
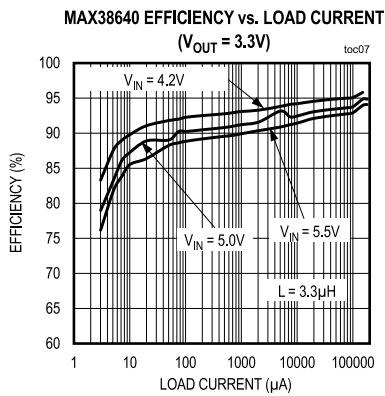
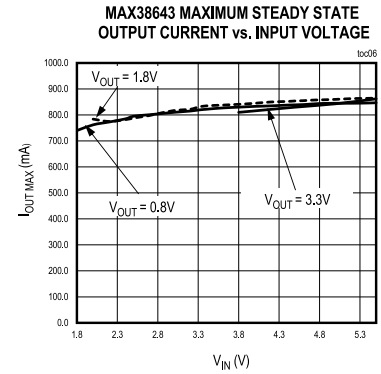
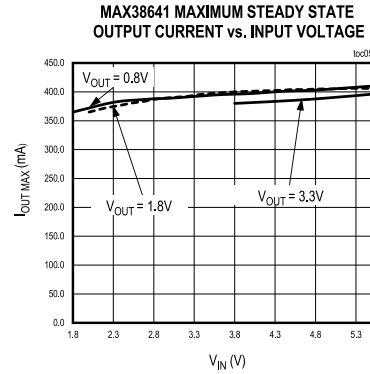
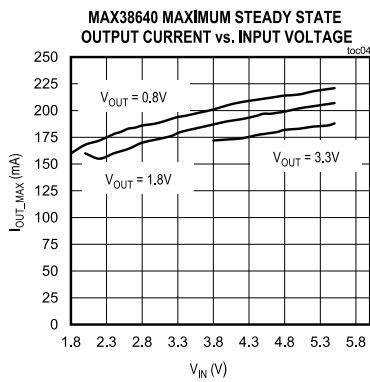
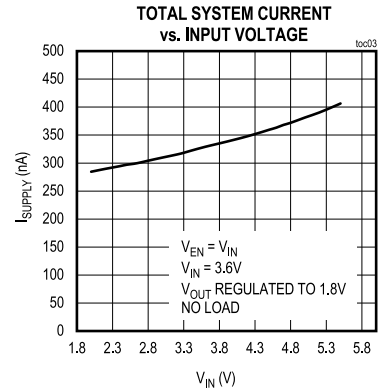
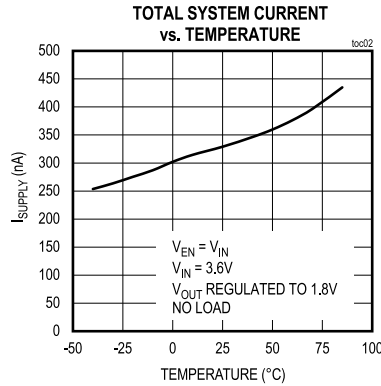
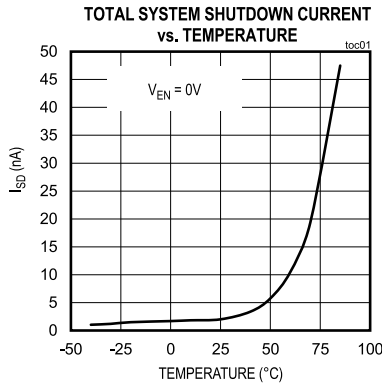



Typical Operating Characteristics (continued)

(MAX38640AENT+, V<sub>IN</sub> = 3.6V, V<sub>OUT</sub> = 1.8V, L = 2.2μH, C<sub>IN</sub> = 10μF, C<sub>OUT</sub> = 22μF, T<sub>A</sub> = +25°C, unless otherwise noted.)

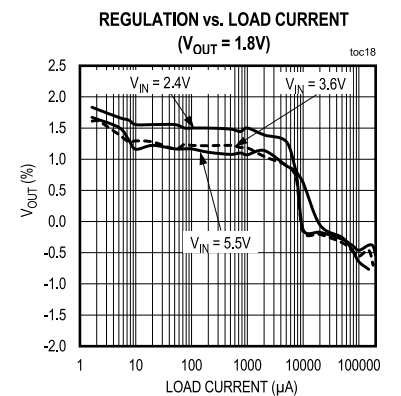
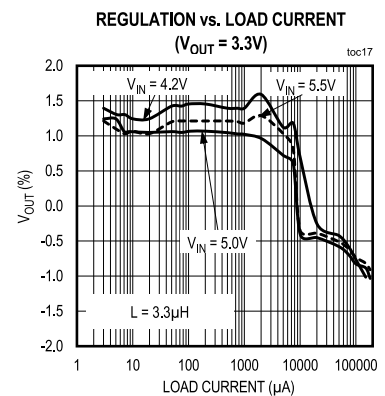
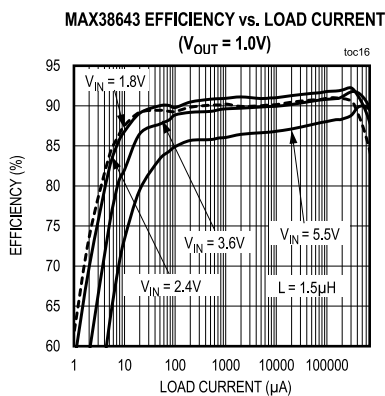
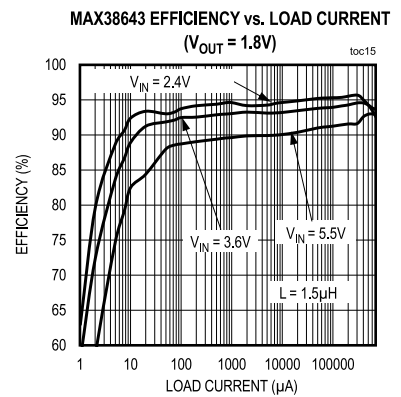
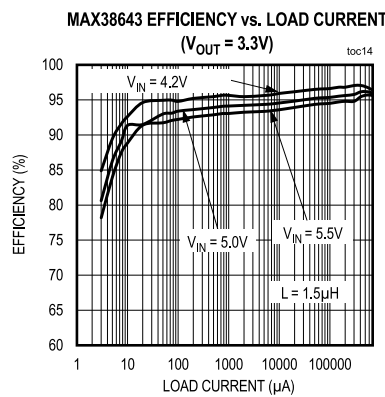
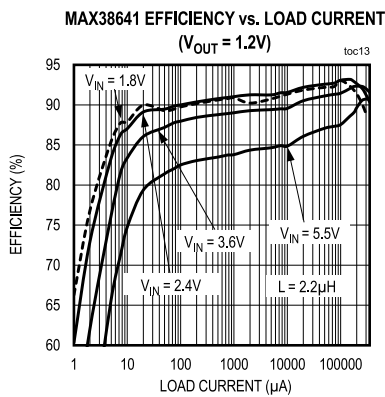
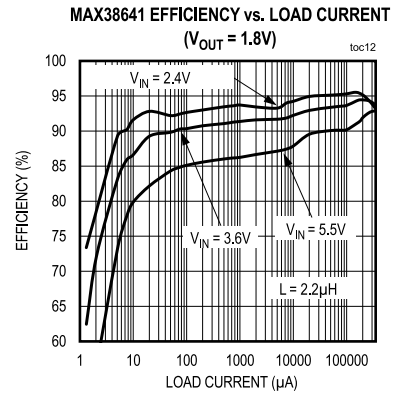
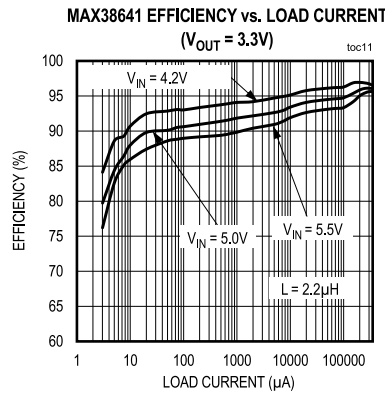
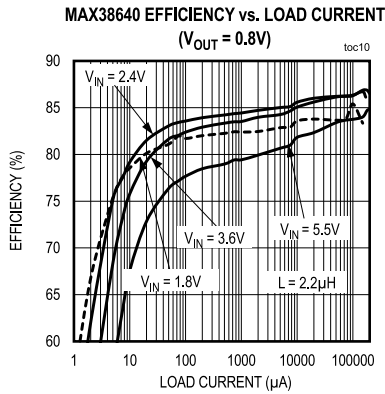

Typical Operating Characteristics (continued)

(MAX38640AENT+,  $V_{IN} = 3.6V$ ,  $V_{OUT} = 1.8V$ ,  $L = 2.2\mu H$ ,  $C_{IN} = 10\mu F$ ,  $C_{OUT} = 22\mu F$ ,  $T_A = +25^\circ C$ , unless otherwise noted.)

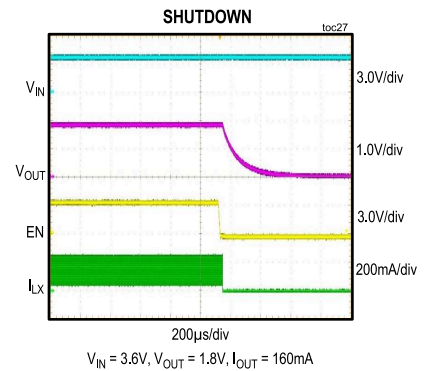
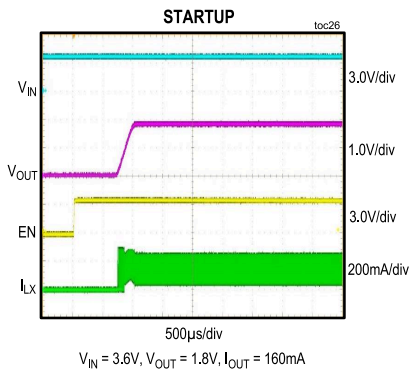
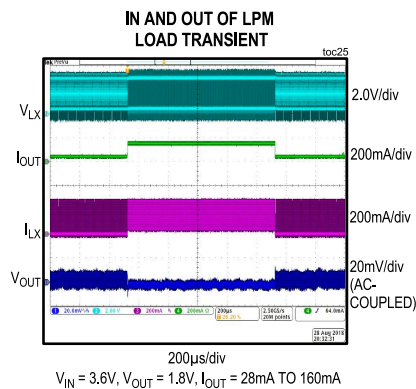
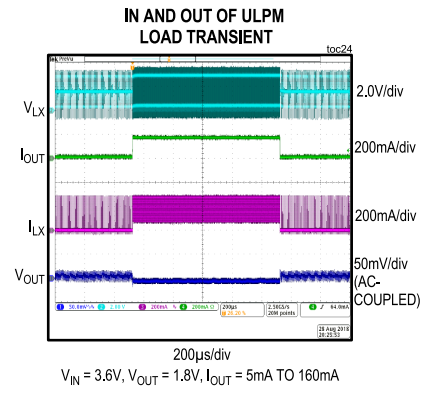
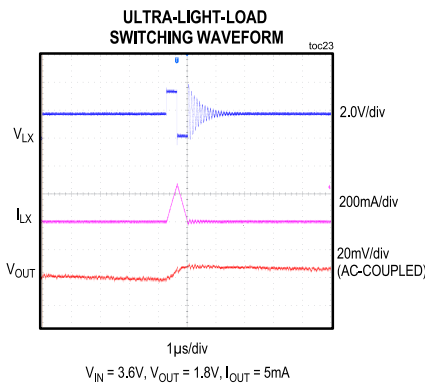
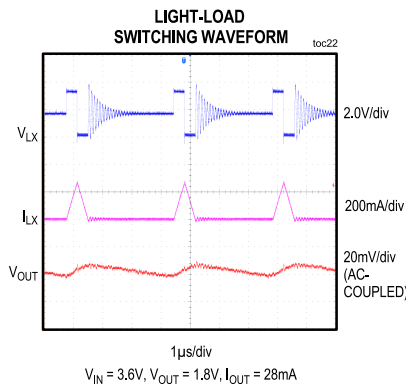
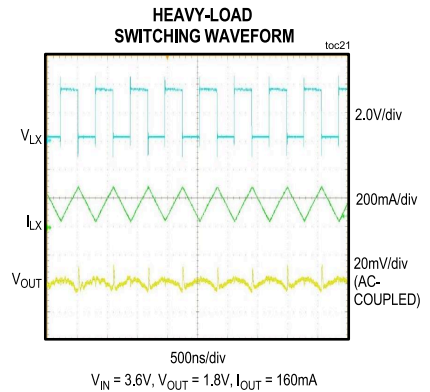
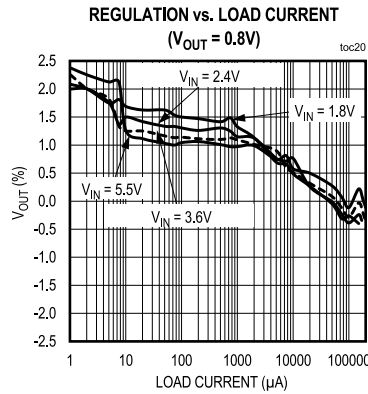
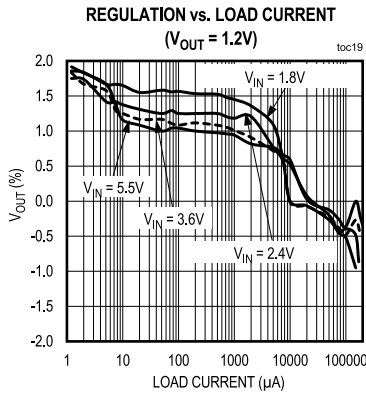

**Typical Operating Characteristics (continued)**

(MAX38640AENT+, V<sub>IN</sub> = 3.6V, V<sub>OUT</sub> = 1.8V, L = 2.2μH, C<sub>IN</sub> = 10μF, C<sub>OUT</sub> = 22μF, T<sub>A</sub> = +25°C, unless otherwise noted.)

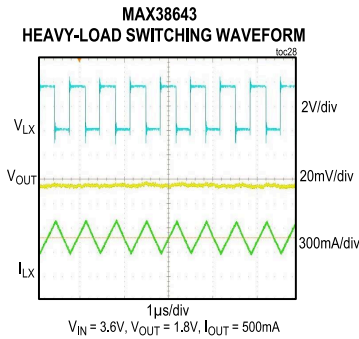

**Pin Configurations**

**6 μDFN**

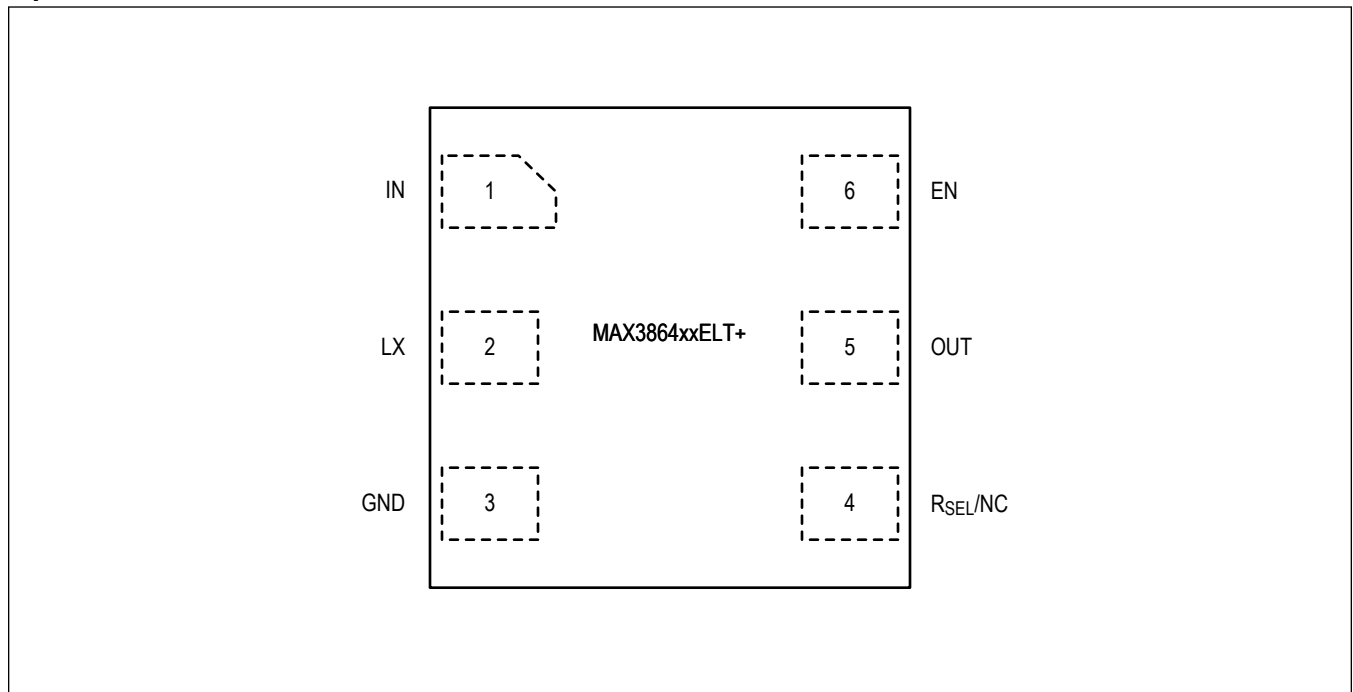

6 WLP

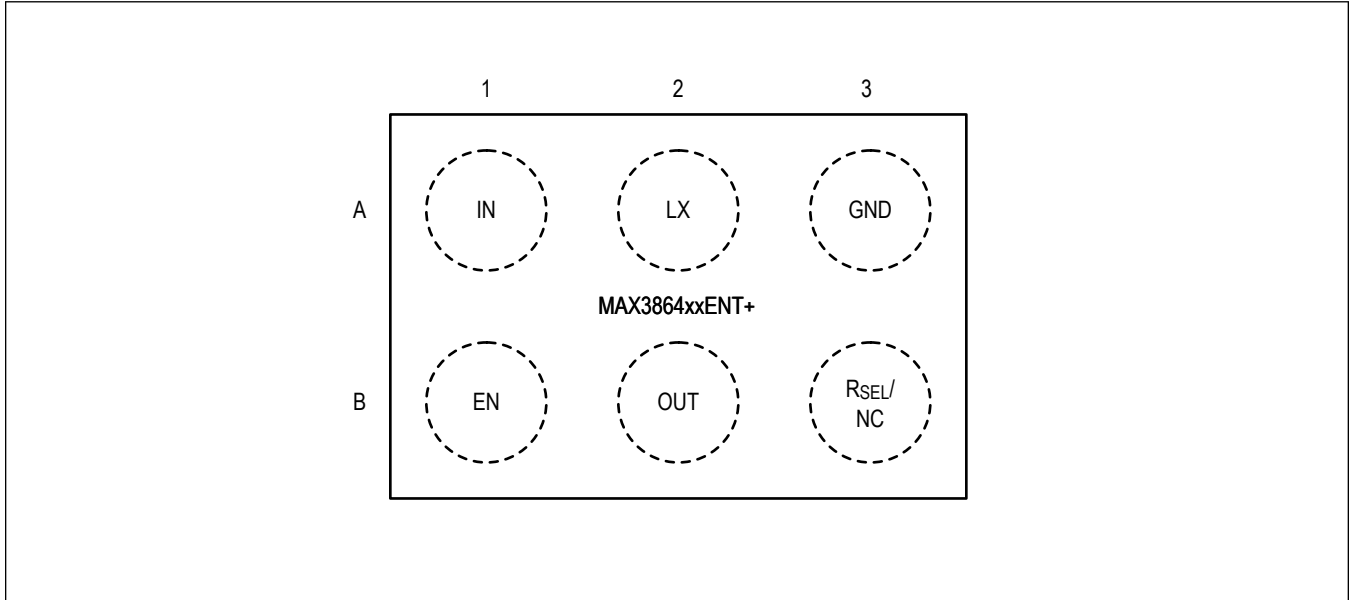

Pin Descriptions

PIN		NAME	FUNCTION
MAX3864xxE LT+	MAX3864xxE NT+		
1	A1	IN	Regulator Supply Input. Connect to a voltage between 1.8V and 5.5V and bypass with a ceramic capacitor from IN to GND.
2	A2	LX	Switching Node. Connect an inductor between LX and the regulator output.
3	A3	GND	Ground.
4	B3	R <sub>SEL</sub> /NC	<b>MAX38640A/1A/2A/3A:</b> Output Voltage Select Input. Connect a resistor from R <sub>SEL</sub> to GND to program the output voltage and IN undervoltage threshold based on <a href="#">Table 1</a> . <b>MAX38640B/1B/2B/3B:</b> No Connect. Leave floating.
5	B2	OUT	Output Voltage Sense Input. Connect to the load at a point where accurate regulation (output capacitor) is required to eliminate resistive metal drops.
6	B1	EN	Enable Input. Force this pin high to enable the buck converter. Force this pin low to disable the part and enter shutdown.

Functional Diagram

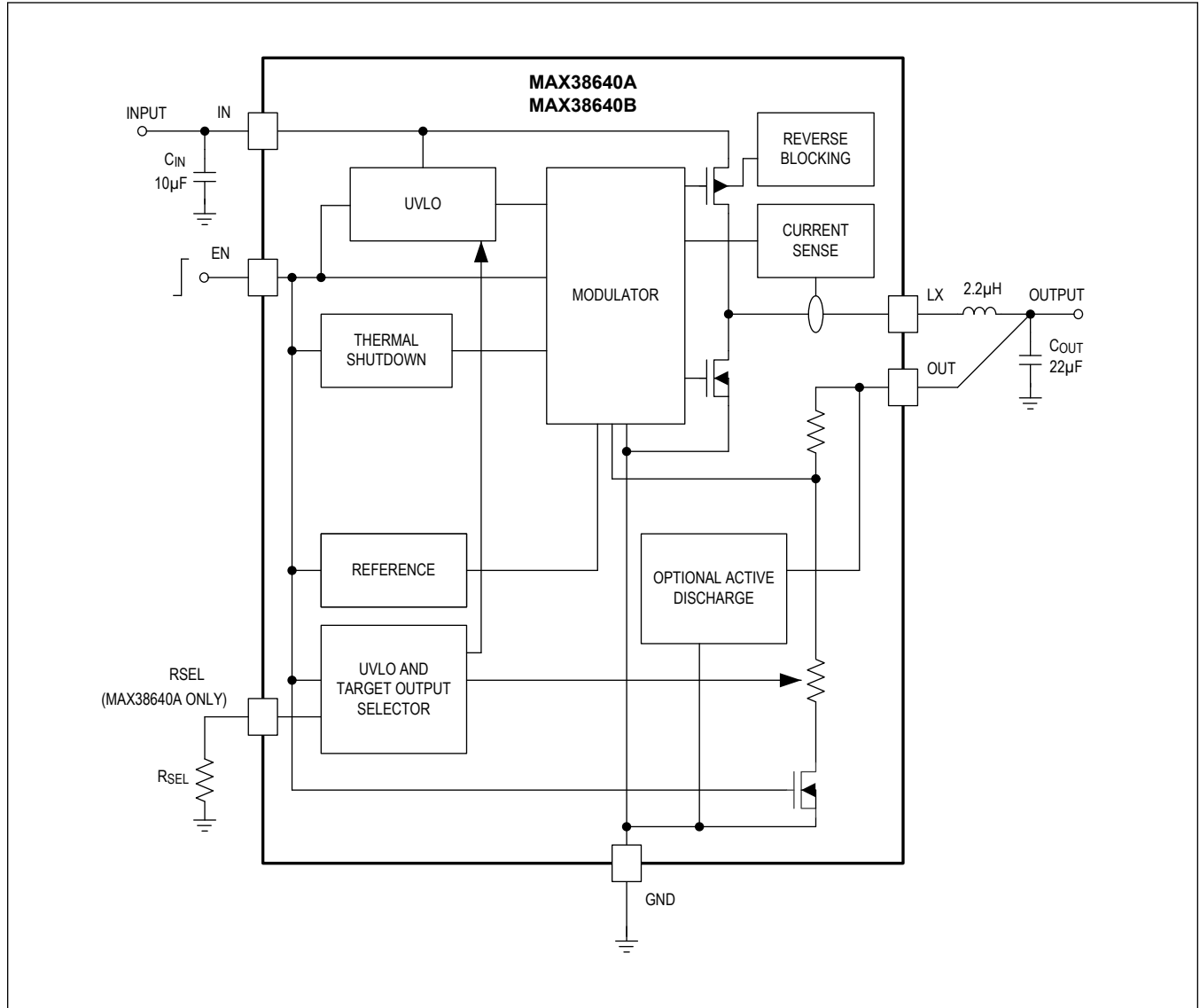

## Detailed Description

The MAX38640–MAX38643 are ultra-low I<sub>Q</sub> (330nA) buck converters that step down from 1.8V to 5.5V to wide range of output voltages between 0.5V and 5V. The output voltage is either programmable on the MAX38640A/1A/2A/3A versions using an external resistor or fixed for the MAX38640B/1B/2B/3B versions. The external R<sub>SEL</sub> resistor on the R<sub>SEL</sub> pin programs the output voltage upon startup for the MAX38640A/1A/2A/3A versions.

The buck converter automatically switches between ultra-low-power mode (ULPM), low-power mode (LPM), and high-power mode (HPM) to better service the load, depending on the load current. The buck converter overregulates in ultra-low-power mode to allow the output capacitor to handle the transient load currents. The device has 90% duty cycle limitation.

Active discharge resistor in the MAX38640/MAX38641/MAX38643 pulls OUT to ground when the part is in shutdown. Active discharge has been strategically omitted for the MAX38642 to preserve the charge on the output capacitor in shutdown. Harvesting applications where the output is connected to a supercapacitor can take advantage of reverse-current blocking feature to preserve the charge on the output capacitor even if the input were to fall below the output in shutdown. Applications where two MAX38642 buck converters are connected in parallel to drive the load can have the input of one of the buck converters to go to 0V in shutdown without dragging the output down or loading the other buck.

## Voltage Configuration

The MAX38640A/1A/2A/3A includes an R<sub>SEL</sub> pin to configure the output voltage and input UVLO threshold on startup. Resistors with tolerance 1% (or better) should be chosen, with nominal values specified in [Table 1](#).

**Table 1. MAX38640A/1A/2A/3A R<sub>SEL</sub> Selection Table**

TARGET OUTPUT VOLTAGE (V)	R <sub>SEL</sub> (kΩ)	INPUT UVLO THRESHOLD, RISING (V)
2.5	OPEN	1.75
2	909	1.75
1.8	768	1.75
1.5	634	1.75
1.3	536	1.75
1.25	452	1.75
1.2	383	1.75
1.15	324	1.75
1.1	267	1.75
1.05	226	1.75
1	191	1.75
0.95	162	1.75
0.9	133	1.75
0.85	113	1.75
0.8	95.3	1.75
0.75	80.6	1.75
0.7	66.5	1.75
3.3	56.2	2.6
3	47.5	2.6
2.8	40.2	2.6

**Table 1. MAX38640A/1A/2A/3A  $R_{SEL}$  Selection Table (continued)**

TARGET OUTPUT VOLTAGE (V)	$R_{SEL}$ (k $\Omega$ )	INPUT UVLO THRESHOLD, RISING (V)
2.75	34	2.6
2.5	28	2.6
2	23.7	2.6
1.8	20	2.6
1.5	16.9	2.6
1.25	14	2.6
1.2	11.8	2.6
1.15	10	2.6
1.1	8.45	2.6
1	7.15	2.6
0.95	5.9	2.6
0.9	4.99	2.6
0.8	SHORT TO GND	2.6

The MAX38640B/1B/2B/3B has a fixed output voltage that is preprogrammed (no  $R_{SEL}$  programming). Contact Maxim to order a part with other preprogrammed output voltage selections. The input UVLO threshold for MAX38640B/1B/2B/3B is 1.75V (typ,  $V_{IN}$  rising) with 50mV hysteresis (typ).

## Applications Information

### Inductor Selection

The inductor value for the MAX38640–MAX38643 affects the ripple current, the transition point from low-power mode (LPM) to ultra-low-power mode (ULPM), and the overall efficiency performance. Based on the peak current limit required for different applications, it is recommended to select an inductor value based on [Table 2](#).

**Table 2. Inductor Selection**

PEAK CURRENT, PART NUMBER	INDUCTANCE RANGE (μH)
1.0A, MAX38643	1.0 to 1.5
500mA, MAX38641/MAX38642	2.2
250mA, MAX38640	2.2 to 4.7

### Input Capacitor

The input capacitor (C<sub>IN</sub>) reduces the peak current drawn from the battery or input power source and reduces the switching noise in the IC. The impedance of C<sub>IN</sub> at the switching frequency should be very low. Ceramic capacitors are recommended with their small size and low ESR. For most MAX38640 applications, use a 10μF ceramic capacitor with X5R or X7R temperature characteristics.

For MAX38641–MAX38643 applications, using a 22μF ceramic input capacitor is recommended. When operating at V<sub>IN</sub> close to the UVLO, more input capacitance may be required to keep the input voltage ripple from tripping the UVLO protection.

### Output Capacitor

The output capacitor (C<sub>OUT</sub>) is required to keep the output voltage ripple small and to ensure loop stability. C<sub>OUT</sub> must have low impedance at the switching frequency. Ceramic capacitors are recommended due to their small size and low ESR. Make sure the capacitor does not degrade its capacitance significantly over temperature and DC bias. Capacitors with X5R or X7R temperature characteristics typically perform well. A 22μF ceramic capacitor is recommended for most MAX38640 and MAX38641/MAX38642 applications. In case of low V<sub>OUT</sub> target levels when using the MAX38641/MAX38642, two 22μF output capacitors are recommended. For MAX38643 applications, use two 22μF output capacitors.

### Enabling Device

The device has a dedicated EN pin. This pin can be driven by a digital signal. It is recommended that the digital signal enables the device after V<sub>IN</sub> crosses the UVLO threshold. In applications where EN is tied to IN, the device is designed to be powered by fast V<sub>IN</sub> slew rates. If V<sub>IN</sub> slew rates are slower than 5V/ms, users must delay enabling the device until after V<sub>IN</sub> crosses the UVLO threshold. This can be done using a simple RC circuit, as shown in [Figure 1](#).

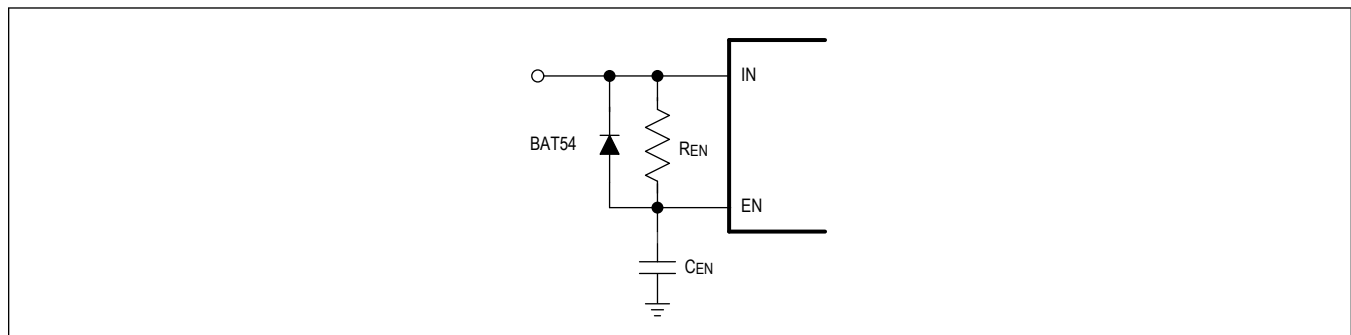

Figure 1. RC Circuit at EN



**PCB Layout and Routing**

High switching frequencies and large peak currents make PCB layout a very important part of the buck regulator design. Good design minimizes excessive electromagnetic interference (EMI) on the feedback paths and voltage gradients in the ground plane to avoid instability and regulation errors. The input capacitor ( $C_{IN}$ ) should be placed as close as possible to the IC pins IN and GND. Connect the inductor,  $C_{IN}$ , and output capacitor ( $C_{OUT}$ ) as close together as possible, and keep their traces short, direct, and wide.

Connect the two GND pins under the IC and directly to the ground of  $C_{OUT}$ . Keep noisy traces, such as the LX node, as short as possible. The OUT pin should be connected to the output capacitor and this trace should be routed away from the main power path between the inductor and  $C_{OUT}$ . The OUT trace should also be routed away from noisy traces such as the LX line or other external noise sources. Refer to the MAX38640–MAX38643 evaluation kit for an example PCB layout and routing scheme.

## Ordering Information

PART NUMBER LEAD FREE FINISH	PART NUMBER TAPE AND REEL	OUTPUT CURRENT (mA)	ACTIVE DISCHARGE	FEATURES	PACKAGE	
MAX38640AELT+	MAX38640AELT+T	175	Yes	0.7V to 3.3V Resistor-Selectable Output Voltage Using R <sub>SEL</sub> Pin	6-pin, 2mm x 2mm µDFN	
MAX38641AELT+	MAX38641AELT+T	350	Yes			
MAX38642AELT+	MAX38642AELT+T	350	No			
MAX38643AELT+	MAX38643AELT+T	700	Yes			
MAX38640BELT+*	MAX38640BELT+T*	175	Yes	0.5V to 5V Preprogrammed Output Voltage		
MAX38641BELT+*	MAX38641BELT+T*	350	Yes			
MAX38642BELT+*	MAX38642BELT+T*	350	No			
MAX38643BELT+*	MAX38643BELT+T*	700	Yes			
MAX38640BELT18+	MAX38640BELT18+T	175	Yes	1.8V Preprogrammed Output Voltage		
MAX38640BELT21+	MAX38640BELT21+T	175	Yes	2.1V Preprogrammed Output Voltage		
MAX38641BELT19+	MAX38641BELT19+T	350	Yes	1.9V Preprogrammed Output Voltage		
MAX38640AENT+	MAX38640AENT+T	175	Yes	0.7V to 3.3V Resistor-Selectable Output Voltage Using R <sub>SEL</sub> Pin		0.4mm pitch, 6-pin (2x3) WLP
MAX38641AENT+	MAX38641AENT+T	350	Yes			
MAX38642AENT+	MAX38642AENT+T	350	No			
MAX38643AENT+	MAX38643AENT+T	700	Yes			
MAX38640BENT+*	MAX38640BENT+T*	175	Yes	0.5V to 5V Preprogrammed Output Voltage		
MAX38641BENT+*	MAX38641BENT+T*	350	Yes			
MAX38642BENT+*	MAX38642BENT+T*	350	No			
MAX38643BENT+*	MAX38643BENT+T*	700	Yes			
MAX38641BENT135+	MAX38641BENT135+T	350	Yes	1.35V Preprogrammed Output Voltage		
MAX38640BENT06+	MAX38640BENT06+T	175	Yes	0.6V Preprogrammed Output Voltage		
MAX38640BENT065+	MAX38640BENT065+T	175	Yes	0.65V Preprogrammed Output Voltage		
MAX38640BENT21+	MAX38640BENT21+T	175	Yes	2.1V Preprogrammed Output Voltage		
MAX38643BENT185+	MAX38643BENT185+T	700	Yes	1.85V Preprogrammed Output Voltage		
MAX38641BENT12+	MAX38641BENT12+T	350	Yes	1.2V Preprogrammed Output Voltage		
MAX38640BENT18+	MAX38640BENT18+T	175	Yes	1.8V Preprogrammed Output Voltage		
MAX38641BENT05+	MAX38641BENT05+T	350	Yes	0.5V Preprogrammed Output Voltage		

\*Future product—contact factory for availability.

+Denotes a lead(Pb)-free/RoHS-compliant package.

T = Tape and reel.

## Revision History

REVISION NUMBER	REVISION DATE	DESCRIPTION	PAGES CHANGED
0	10/18	Initial release	—
1	1/19	Updated <i>Typical Operating Characteristics</i> , <i>Pin Descriptions</i> , <i>Functional Diagram</i> , <i>Applications Information</i> , and <i>Ordering Information</i>	5, 6, 8, 9, 13, 14
2	5/19	Updated title of data sheet and changed part number references, updated <i>Typical Operating Characteristics</i>	1, 3–5, 7, 9–15
3	4/20	Updated <i>Ordering Information</i>	14
4	9/20	Updated <i>Ordering Information</i>	14
5	3/21	Removed <i>Table 2</i> , updated <i>Ordering Information</i>	12, 14
6	8/21	Updated <i>Absolute Maximum Ratings</i> , <i>Electrical Characteristics</i> , <i>Functional Diagram</i> , and <i>Ordering Information</i>	2, 3, 10, 14
7	1/22	Updated <i>Ordering Information</i>	14
8	2/22	Updated <i>Ordering Information</i>	14
9	4/22	Updated <i>Typical Operating Characteristics</i>	10
10	1/23	Updated <i>Ordering Information</i>	17
11	8/24	Updated <i>Ordering Information</i>	17