

QT-Brightek Chip LED Series

SMD 1209 LED

Part No.: QBLP653R Series

R: Reverse Mount



Table of Contents:

Introduction 3

Electrical / Optical Characteristic (Ta=25 °C) 4

Absolute Maximum Rating 4

CIE Chromaticity Table 7

Characteristic Curves..... 8

Solder Profile & Footprint..... 10

Packing 11

Labeling 12

Ordering Information 12

Revision History 13

Disclaimer 13

Introduction

Feature:

- Water clear lens
- Yellow diffused lens (white color only)
- Package in tap and reel
- Reverse mount (bottom entry)
- Bright 1209 LED package
- Beam angle: 15 deg typ.
- Beam angle: 130° typ. (White color only)
- Pkg height: 2.5mm

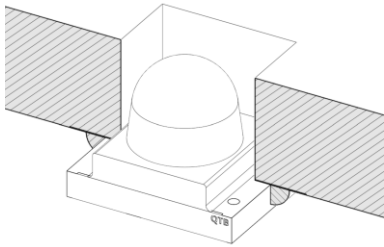

Application:

- Status indication
- Back lighting application
- Light pipe
- Signal

Certification & Compliance:

- ISO9001
- RoHS Compliant



Dimension:

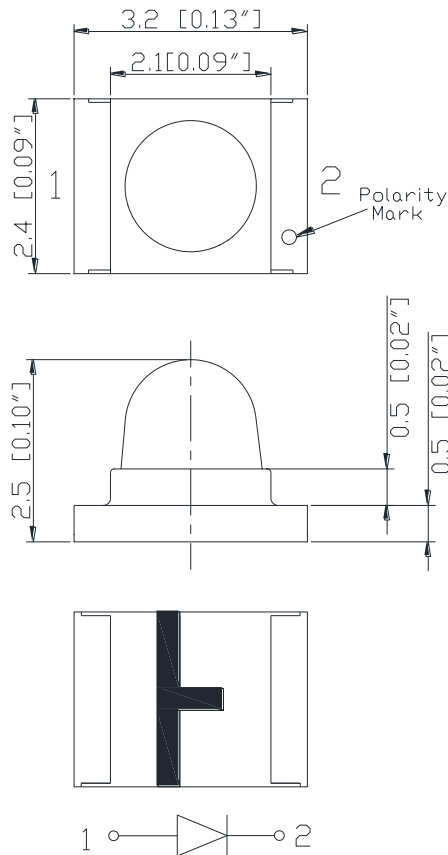

Units: mm / tolerance = +/-0.15mm

Electrical / Optical Characteristic (Ta=25 °C)

Product	Color	IF (mA)	VF (V)		λD (nm)			λP (nm)	IV (mcd)	
			Typ.	Max.	Min.	Typ.	Max.	Typ.	Min.	Typ.
QBLP653R-R	Red	20	2.0	2.5	620	625	630	630	2000	3850
QBLP653R-Y	Yellow	20	2.0	2.5	585	590	595	590	1600	3400
QBLP653R-O	Orange	20	2.0	2.5	600	605	610	610	1600	3350
QBLP653R-AG	Yellow Green	20	2.0	2.5	565	570	576	572	500	1000
QBLP653R-IG	Green	20	3.2	3.7	520	525	530	520	4000	11000
QBLP653R-IB	Blue	20	3.2	3.7	455	460	465	455	400	750
QBLP653R-IW	White	20	3.1	3.7	X = 0.25 Y = 0.24	X = 0.28 Y = 0.29	X = 0.33 Y = 0.34	-	100	180

Absolute Maximum Rating

Material	Pd (mW)	IF (mA)	IFP (mA)*	VR (V)	TOP (°C)	TST (°C)	TSOL (°C)**
AllnGaP	75	30	125	5	-40 ~ +80	-40 ~ +85	260
InGaN	111	30	125	5	-40 ~ +80	-40 ~ +85	260

*Duty 1/8 @ 1KHz

**IR Reflow for no more than 10 sec @ 260 °C

Forward Voltage VF for AllnGaP @IF=20mA

Bin	Min.	Max.	Unit
□	1.7	2.5	V

Forward Voltage VF for InGaN @IF=20mA

Bin	Min.	Max.	Unit
f	2.8	3.1	V
g	3.1	3.4	
h	3.4	3.7	

Luminous Intensity I_V @ $I_F=20mA$

Bin	Min.	Max.	Unit
J	100	125	mcd
K	125	160	
L	160	200	
M	200	250	
N	250	320	
O	320	400	
P	400	500	
Q	500	630	
R	630	800	
S	800	1000	
T	1000	1250	
U	1250	1600	
V	1600	2000	
W	2000	2500	
X	2500	3200	
Y	3200	4000	
Z	4000	5200	
a	5200	6800	
b	6800	8800	
c	8800	11200	
d	11200	14200	
e	14200	18000	

Dominant Wavelength λ_D for Red @ $I_F=20mA$

Bin	Min.	Max.	Unit
t	620	625	nm
u	625	630	

Dominant Wavelength λ_D for Yellow @ $I_F=20mA$

Bin	Min.	Max.	Unit
m	585	590	nm
n	590	595	

Dominant Wavelength λ_D for Yellow Green @ $I_F=20mA$

Bin	Min.	Max.	Unit
h	565	568	nm
i	568	572	
j	572	576	

Dominant Wavelength λ_D for Blue @ $I_F=20\text{mA}$

Bin	Min.	Max.	Unit
C	455	457.5	nm
D	457.5	460	
E	460	462.5	
F	462.5	465	

Dominant Wavelength λ_D for Green @ $I_F=20\text{mA}$

Bin	Min.	Max.	Unit
U	520	522.5	nm
V	522.5	525	
W	525	527.5	
X	527.5	530	

Dominant Wavelength λ_D for Orange @ $I_F=20\text{mA}$

Bin	Min.	Max.	Unit
p	600	605	nm
q	605	610	

CIE Chromaticity Table

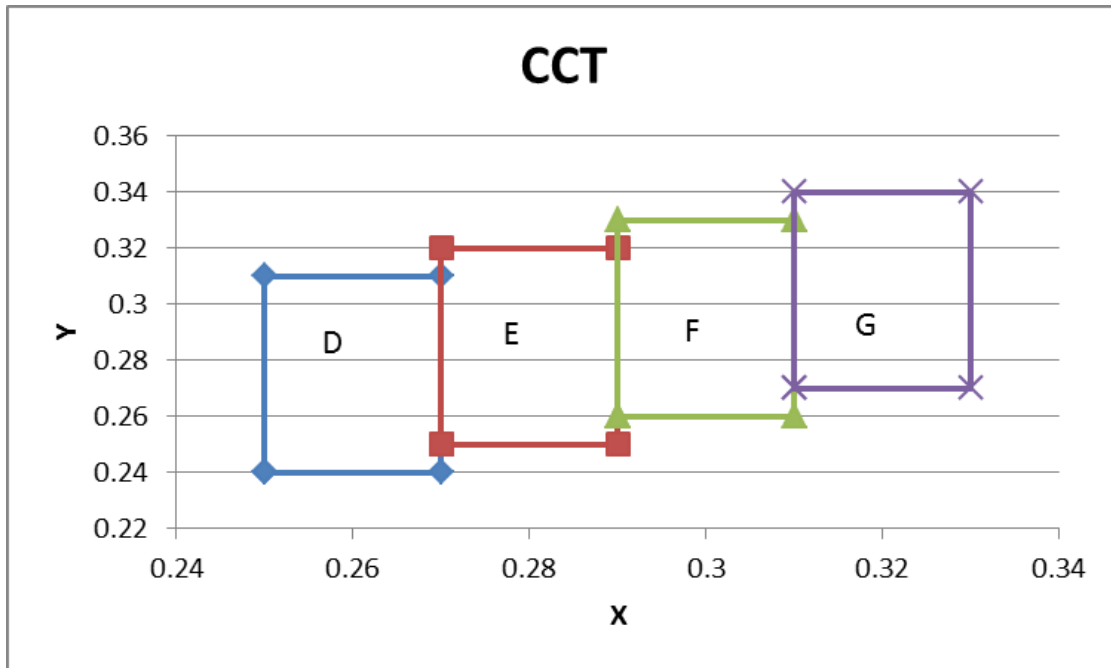

D		E		F		G	
X	Y	X	Y	X	Y	X	Y
0.25	0.24	0.27	0.25	0.29	0.26	0.31	0.27
0.25	0.31	0.27	0.32	0.29	0.33	0.31	0.34
0.27	0.31	0.29	0.32	0.31	0.33	0.33	0.34
0.27	0.24	0.29	0.25	0.31	0.26	0.33	0.27
0.25	0.24	0.27	0.25	0.29	0.26	0.31	0.27

Characteristic Curves

AllnGaP (R/Y/O/AG)

Forward Current vs. Forward Voltage

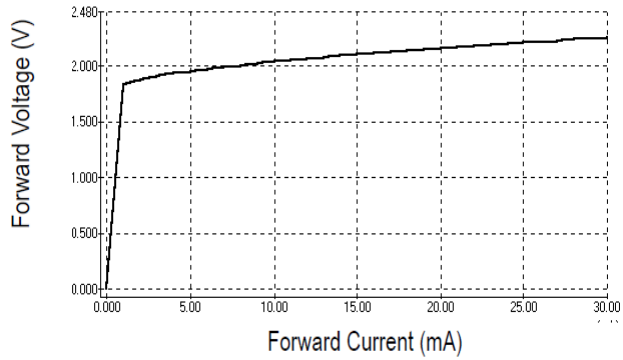

Relative Intensity vs. Wavelength

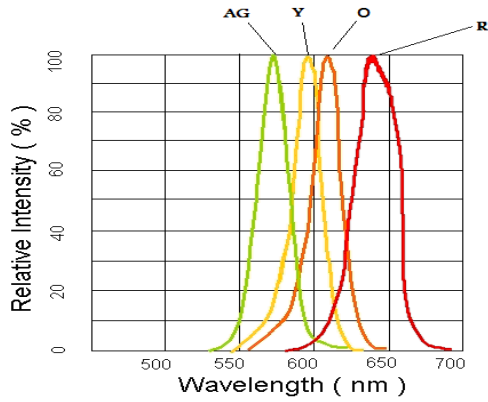

Directive Characteristics

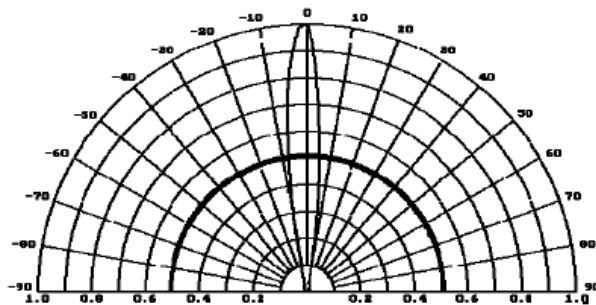

InGaN (IB/IW)

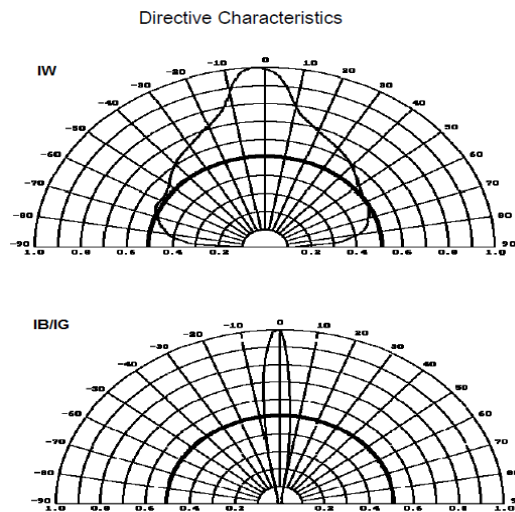
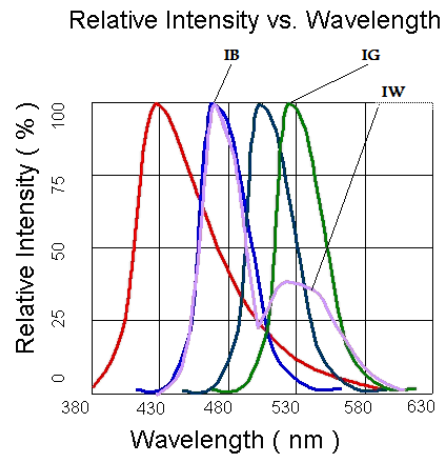
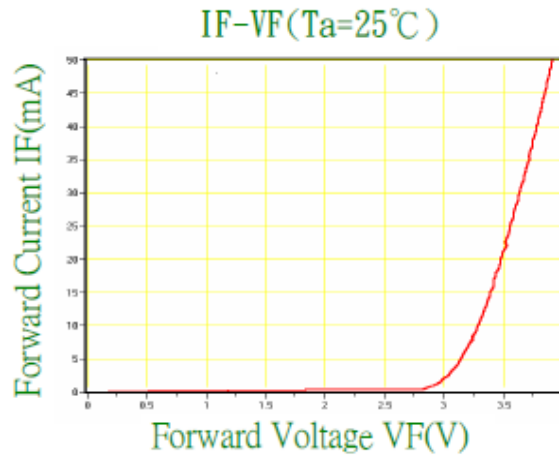

Solder Profile & Footprint

-The recommended reflow soldering profile is as follows (temperatures indicated are as measured on the surface of the LED resin):

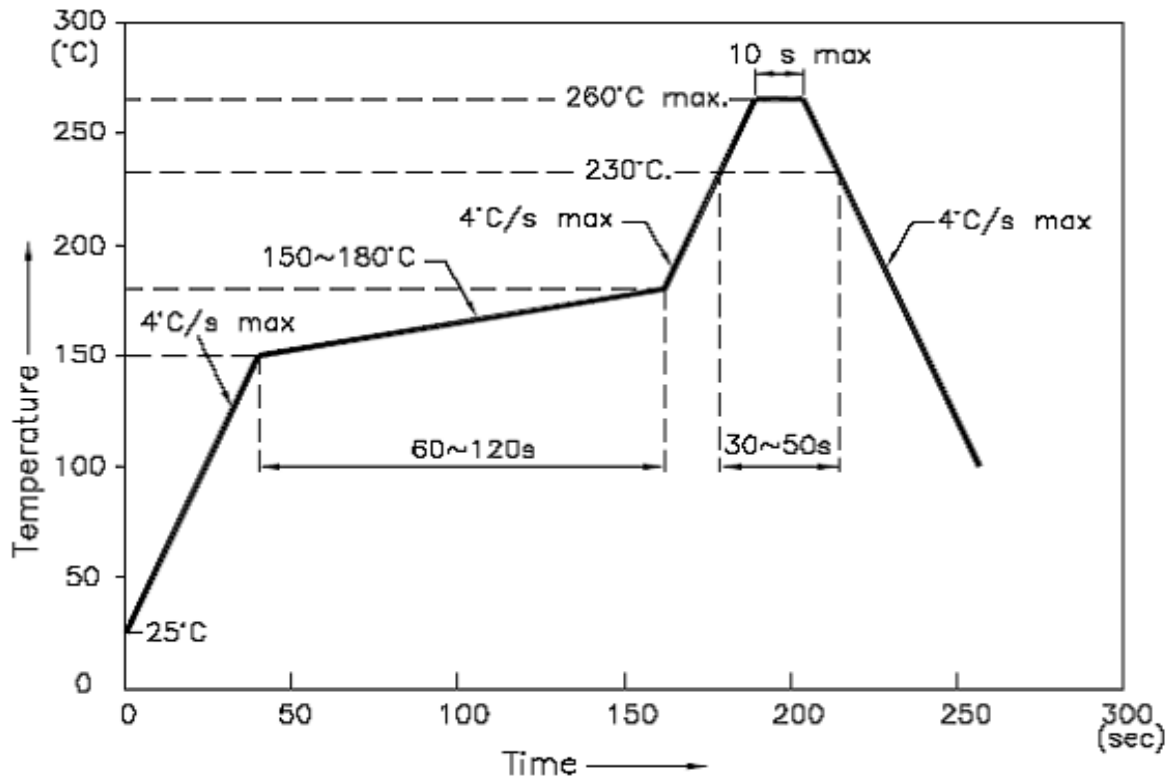

Recommended Pad Layout	Mounting Illustration
Unit: mm	

Packing

Reel Dimension:

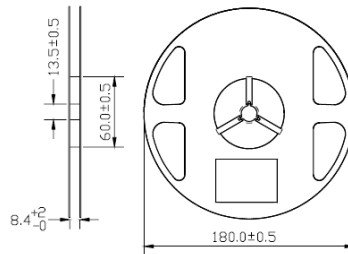

Unit: mm

Tape Dimension:

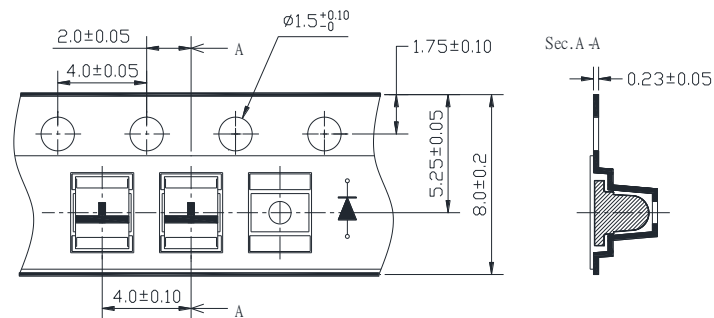

Unit: mm

Arrangement of Tape:

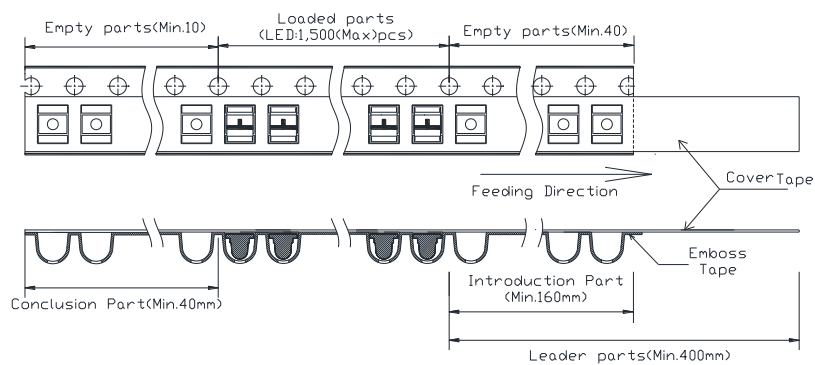

Packaging Specification:

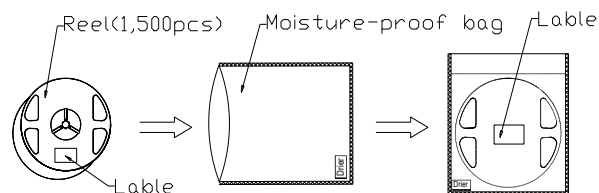

Labeling



Part No: _____
Customer P/N: _____
Item: _____
Q'ty: _____
Vf: _____
Iv: _____
WI: _____
Date: _____

Made in China

Ordering Information

Orderable Part #	Spec Range	Quantity per reel
QBLP653R-R	Iv=3850mcd typ. @ 20mA / λd=620nm ~ 630nm	1,500 units
QBLP653R-Y	Iv=3400mcd typ. @ 20mA / λd =585nm ~ 595nm	1,500 units
QBLP653R-O	Iv=3350mcd typ. @ 20mA / λd =600nm ~ 610nm	1,500 units
QBLP653R-AG	Iv=1000mcd typ. @ 20mA / λd =565nm ~ 576nm	1,500 units
QBLP653R-IG	Iv=11000mcd typ. @ 20mA / λd=520nm ~ 530nm	1,500 units
QBLP653R-IB	Iv=750mcd typ. @ 20mA / λd=455nm ~ 465nm	1,500 units
QBLP653R-IW	Iv=180mcd typ. @ 20mA / CIE Coordinate: (X=0.28, Y=0.29) typ.	1,500 units



Revision History

Description:	Revision #	Revision Date
New Release of QBLP653R_series	V1.0	12/08/2011
Amend Pad Layout	V1.1	02/16/2012
Update format	V1.2	05/24/2012
Update drawing dimension and spec for AG	V2.0	11/18/2016
Fix packing spec drawing and dimension and tolerance error	V2.1	01/09/2017
Add peak wavelength	V2.2	07/5/2024

Disclaimer

QT-BRIGHTEK reserves the right to make changes without further notice to any products herein to improve reliability, function or design. QT-BRIGHTEK does not assume any liability arising out of the application or use of any product or circuit described herein; neither does it convey any license under its patent rights, nor the rights of others.

Life Support Policy

QT-BRIGHTEK's products are not authorized for use as critical components in life support devices or systems without the express written approval of QT-BRIGHTEK. As used herein:

1. Life support devices or systems are devices or systems which, (a) are intended for surgical implant into the body, or (b) support or sustain life, and (c) whose failure to perform when properly used in accordance with instructions for use provided in the labeling, can be reasonably expected to result in a significant injury of the user.
2. A critical component in any component of a life support device or system whose failure to perform can be reasonably expected to cause the failure of the life support device or system, or to affect its safety or effectiveness.