

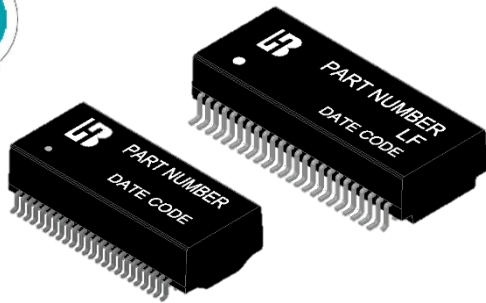



# 5GBase-T Dual Port Magnetic Modules

QGS2014xx, QGS2015xx



-  IEEE802.3bz/af/at/bt Compliant Options
-  Compatible with all Major PHYs
-  RoHS compliant and Halogen Free
-  Ideal for Commercial or Industrial switches and high-volume consumer applications

## Electrical Specification @ 25°C

PART NUMBER	Media side Inductance (@100KHz/0.1Ve) uH min	Insertion Loss dB max		Return Loss dB min		PoE (Current Per Pair mA)	Operating Temperature (°C)	Isolation (Pri:Sec)	Note
		1-100 MHz	100-250 MHz	1- 40 MHz	40< f ≤ 250 MHz				
		QGS2014R	180	-1.0	-2.0				
QGS2015RS	180	-1.0	-2.0	-16	- (16-10 log <sub>10</sub> (f /40))	-	0 to 70	4000Vrms	Surge DM 4.3KV
QGS6014R	180	-1.0	-2.0	-16	- (16-10 log <sub>10</sub> (f /40))	600	0 to 70	1500Vrms	-
QGS6014RM	180	-1.0	-2.0	-16	- (16-10 log <sub>10</sub> (f /40))	600	-40 to 85	1500Vrms	-
QGS6015RS	180	-1.0	-2.0	-16	- (16-10 log <sub>10</sub> (f /40))	600	0 to 70	4000Vrms	Surge DM 4.3KV
QGS9015RAM	180	-1.0	-2.0	-16	- (16-10 log <sub>10</sub> (f /40))	1000	-40 to 105	1500Vrms	-

Note: Refer to the specification for detail

## Process and Materials

1. Storage Temperature: Refer to the specification for details
2. Compliance to J-STD:
  - A. J-STD-002: Solderability at 245 °C Reflow Profile
  - B. J-STD-020: Moisture Sensitive Level 1
  - C. J-STD-075: R7, 245 °C Maximum Through Reflow Solder
3. All parts come in 13" (330mm) Diameter Tape and reel | - see page 3 for details
4. Header: DAP (Diallyl Phthalate) with flammability Rating UL 94V-0 or better
5. Lead Frame: Cooper Alloy
  - Underplated: Half Hard Ductile Nickel 40-118" (1.0 -3.0um)
  - Over plated: 100% Tin electro-deposited per 240~400u"Min(6~10um)
  - Finish: Matte finish 100% Tin solde

# 5GBase-T Dual Port Magnetic Modules

QGS2014xx, QGS2015xx

## Mechanical

### QGS2014xx

### QGS2015xx

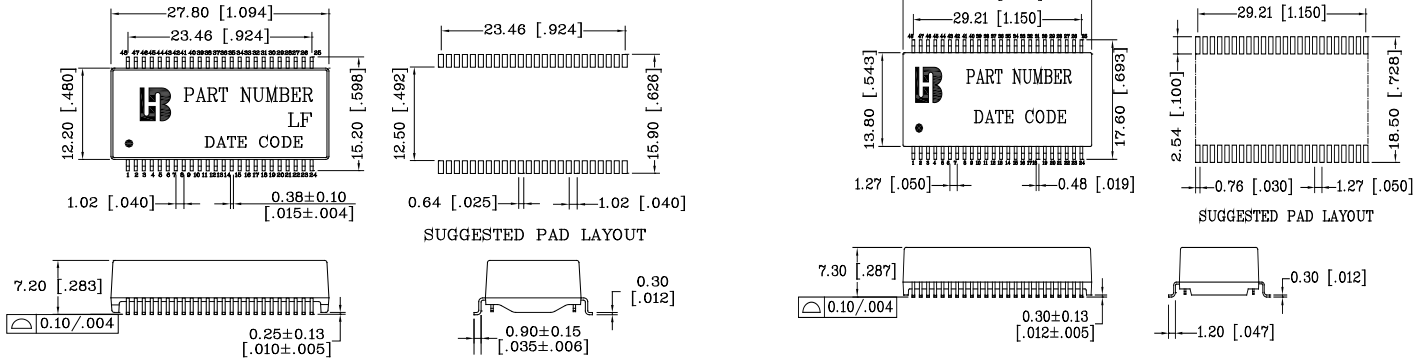

Dimensions: mm / [Inches]  
 Unless otherwise specified, all tolerances are:  $xx.xx \pm 0.25$  [.010]  
 $0.xx \pm 0.05$  [.002]

## Schematic

### QGS2014R, QGS6014R, QGS6014RM, QGS2015RS, QGS6015RS, QGS6015RS

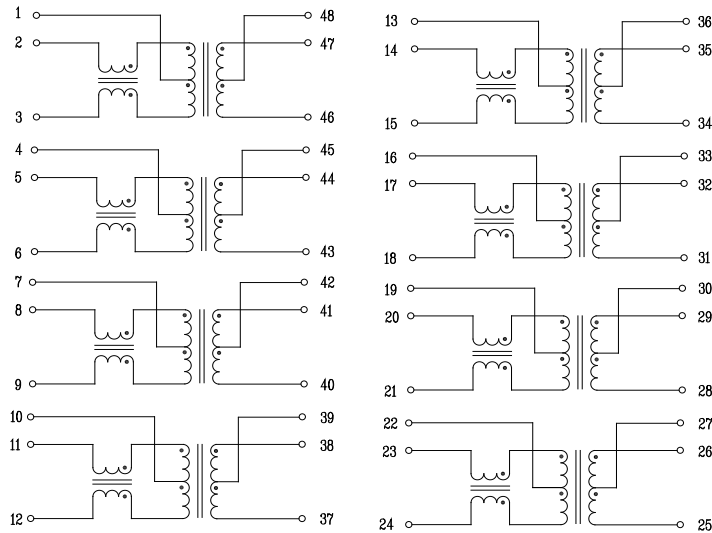

# 5GBase-T Dual Port Magnetic Modules

QGS2014xx, QGS2015xx

## Tape & Reel

### QGS2014R, QGS6014R, QGS6014RM

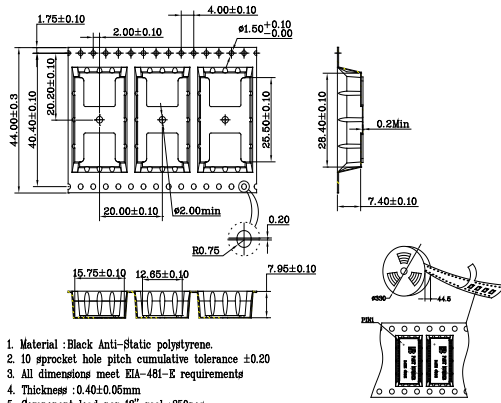

### QGS2015RS, QGS6015RS, QGS6015RS

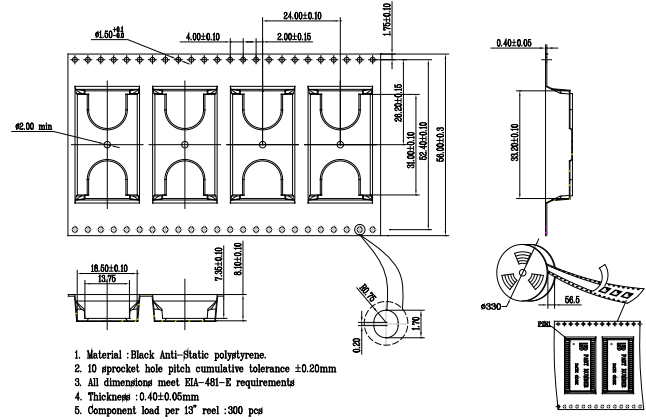

## Carton Package

### QGS2014R, QGS6014R, QGS6014RM

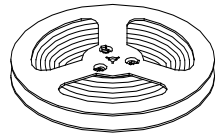

REEL

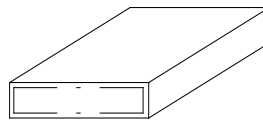

INNER BOX: 347x347x82

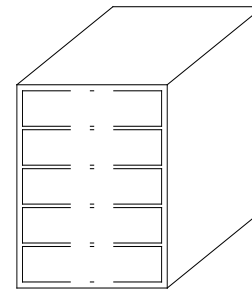

OUTER CARTON: 375x375x470

1. 1 REEL=350PCS
2. 1 INNER BOX=1 REEL=350PCS
3. 1 OUTER CARTON=5 INNER BOXES=1750PCS

### QGS2015RS, QGS6015RS, QGS6015RS



REEL

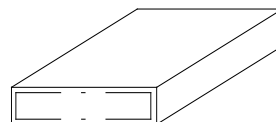

INNER BOX: 347x347x82

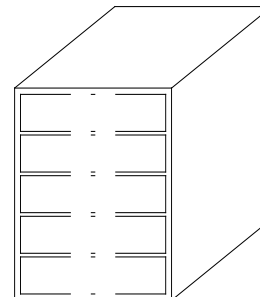

OUTER CARTON: 375x375x470

1. 1 REEL=350PCS
2. 1 INNER BOX=1 REEL=350PCS
3. 1 OUTER CARTON=5 INNER BOXES=1750PCS

## For More Information:

[Americas-prodinfonetworkamericas@pulseelectronics.com](mailto:Americas-prodinfonetworkamericas@pulseelectronics.com) | [Europe-comms-Apps-Europe@pulseelectronics.com](mailto:Europe-comms-Apps-Europe@pulseelectronics.com) | [Asia-prodinfonetworkapac@pulseelectronics.com](mailto:Asia-prodinfonetworkapac@pulseelectronics.com)

Performance warranty of products offered on this datasheet is limited to the parameters specified. Data is subject to change without notice. Other brand and product names mentioned herein maybe trademarks or registered trademarks of their respective owners.

©Copyright,2021.PulseElectronics,Inc.Allrightsreserved.