



QLUV07N2DM
3535 10mW UVC LED



Product Outline:

The high output ceramic type 3535 with 35 degree view angle LEDs, UVC LED series are designed for high current operation and high power output applications. Quelighting UV LED is ideal UV light source for water disinfection.

Features:

- UVC LED
- **Quartz glass lens**
- Max. current = **150mA** , up to **1.5W**
- Package Dimension = 3.5mmX3.5mmX3.15mm
- Ceramic substrate
- MSL 3 qualified according to J-STD 020
- Low thermal resistance
- View angle = **35** degree
- RoHS compliant
- Custom Bin available upon special request

Application:

- Water disinfection
- Air purifiers
- Disinfection
- Phototherapy
- Bio-Analysis/DetectionFeatures

Compliance and Certification:



Mechanical Property: 35 Degree Field Angle

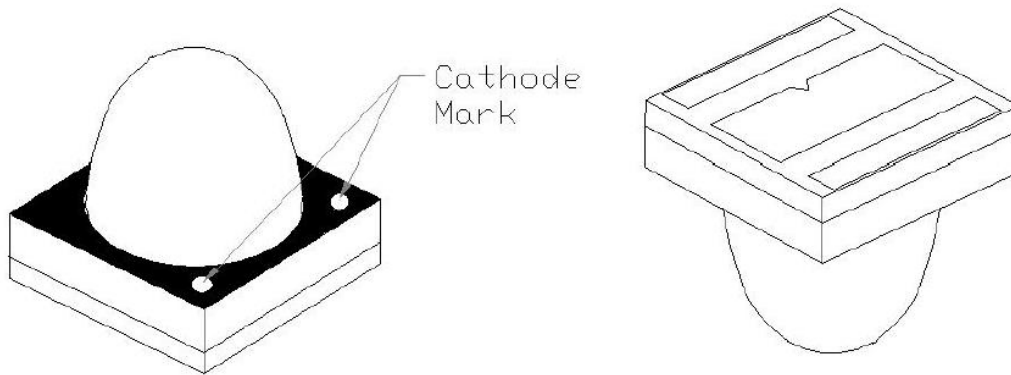
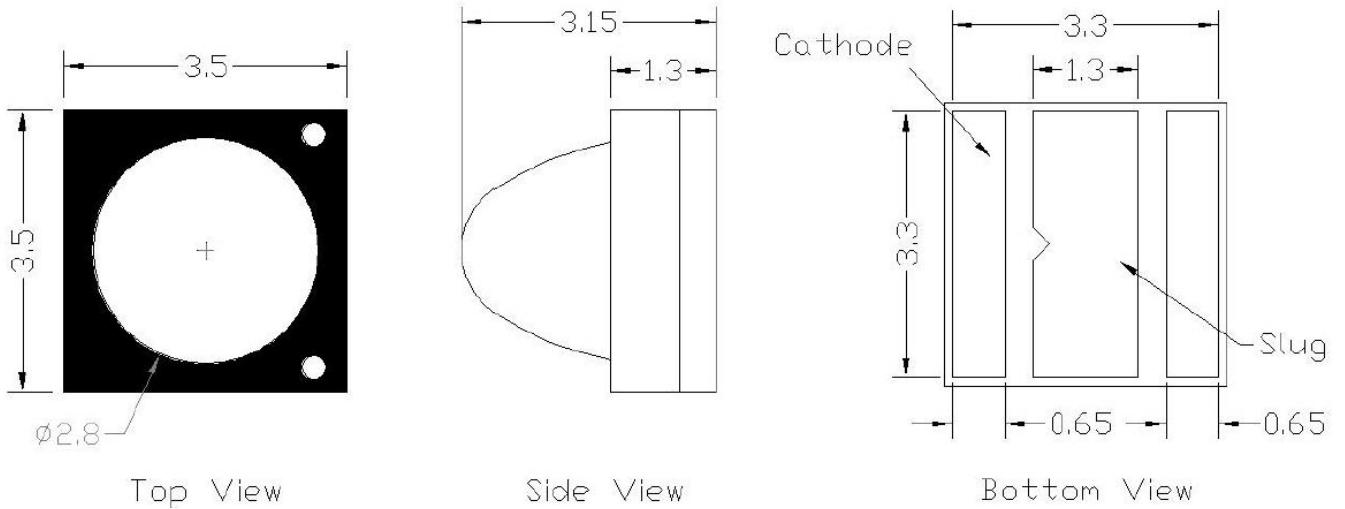

Circuit Diagram

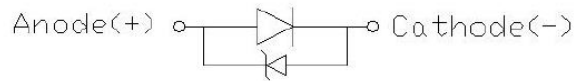

Note:

1. All dimension in millimeters
2. tolerance is $\pm 0.2\text{mm}$



Recommended Solder footprint:

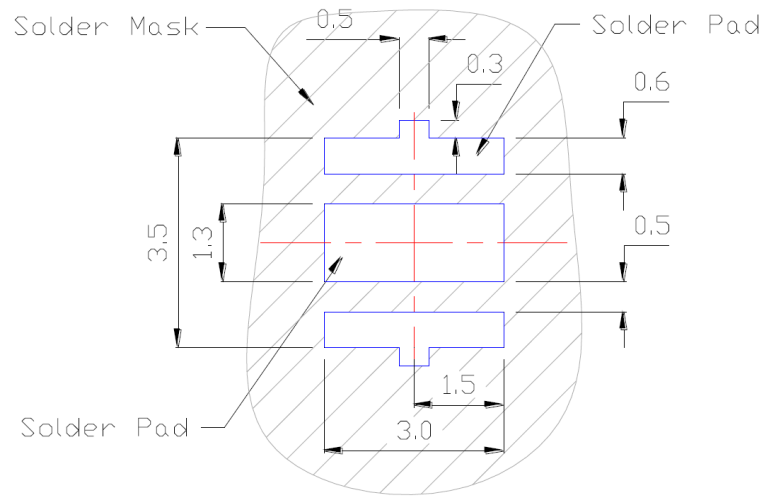

Note:

1. All dimension in millimeters
2. The drawing without tolerances is for reference only
3. Suggest stencil T=0.12 mm

Electrical / Optical Characteristic

(T=25 °C)

Product	View angle	I _F (mA)	V _F (V)		Wavelength (nm)	Radiant Power(mW)	
			Typ.	max		min	typ.
QLUV07N2DM	35	100	7	10	265-285	8	11.5

- (1) The Forward Voltage tolerance is $\pm 0.1V$
- (2) The Peak wavelength tolerance is ± 2
- (3) The Radiant power is $\pm 7\%$



Absolute Maximum Rating

(T=25 °C)

Part #	P _d (mW)	I _F (mA)	I _{FP} (mA)*	V _R (V)	T _{OP} (°C)	T _{ST} (°C)	T _J (°C)**	T _{SOL} (°C)**	R _{th(J-S)} (C/W)***
QLUV07N2DM	1.5	150	180	-5	-40 – 60	-40 - 85	85	260	15

*Duty 1/10 @ 10Khz

** Junction Temperature

*** IR Reflow for no more than 10 sec @ 260 °C

**** Thermal resistance is calculated from junction to solder

Peak Wavelength Binning

Wavelength Rank @ 100mA			
Code name	Low	High	Units
U265T	265	275	nm
U275T	275	285	

Forward Voltage (V_F) Bin:

VF Rank @ 100mA			
Code name	Min.	Max.	Units
A	5.0	5.5	V
B	5.5	6.0	
C	6.0	6.5	
D	6.5	7.0	
E	7.0	7.5	
F	7.5	8.0	

The forward voltage tolerance is ± 0.1V



Characteristic Curves

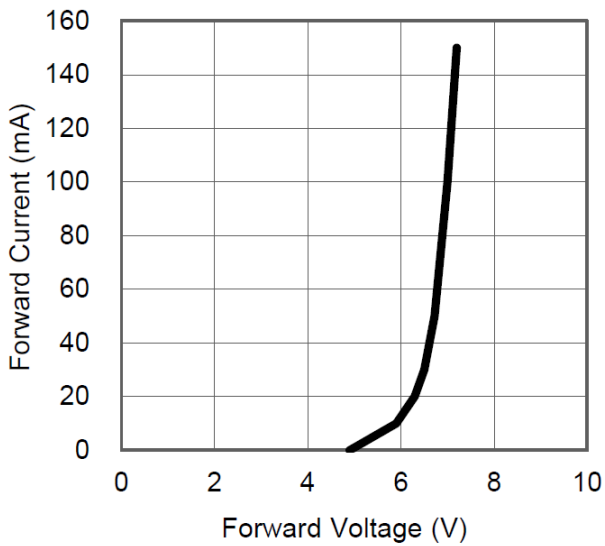

Forward Voltage vs. Forward Current

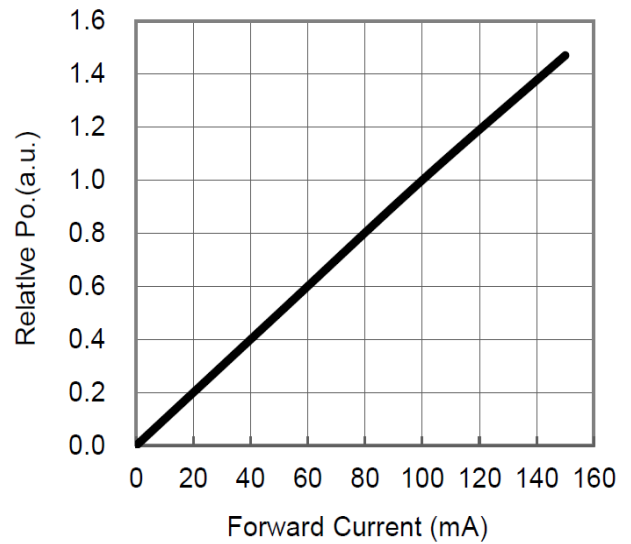

Forward current vs. Relative luminous intensity

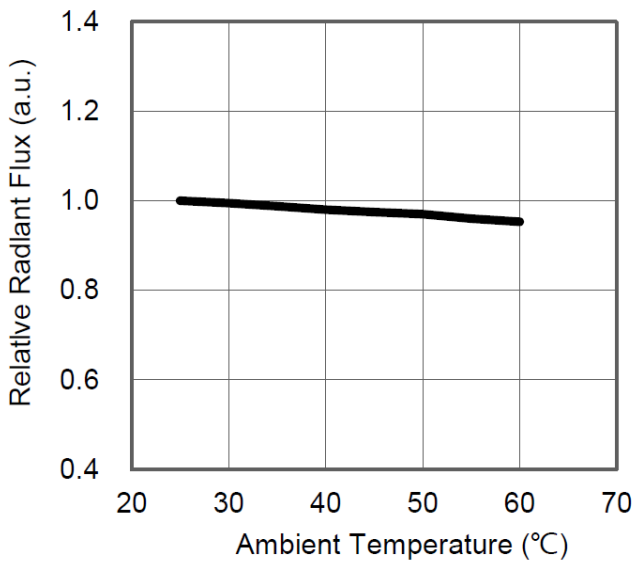

Relative Luminous Intensity vs Ambient Temperature

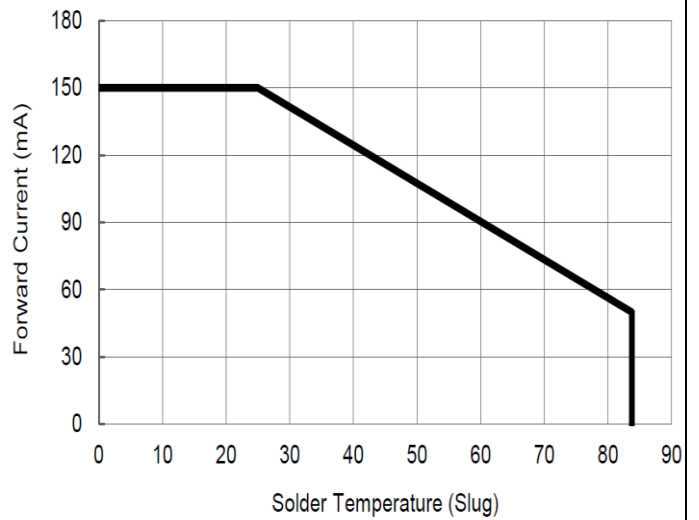

Solder Temperature (Slug) vs. Maximum Forward Current



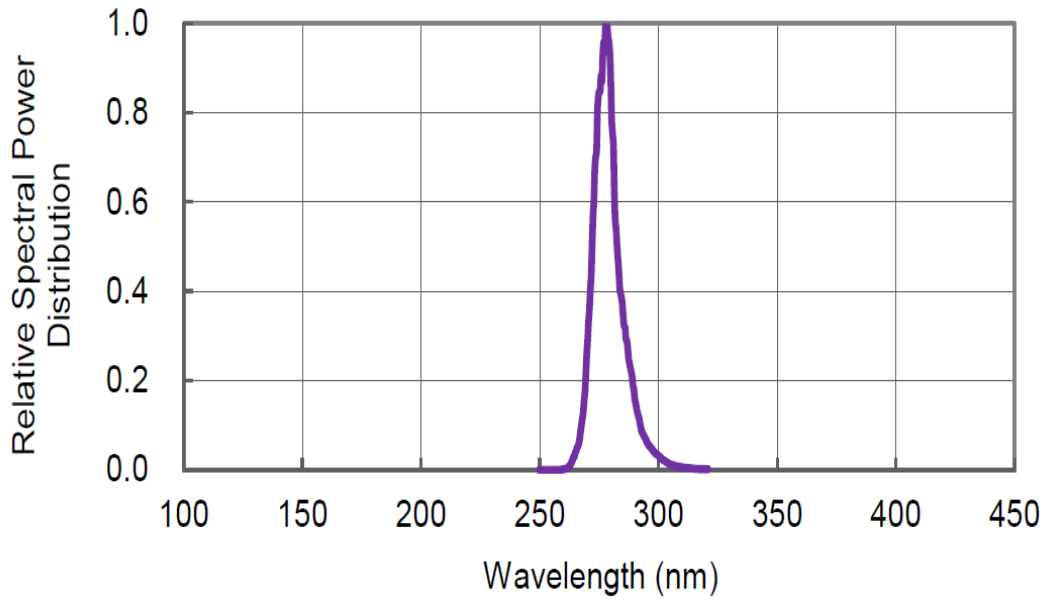

Spectrum Distribution

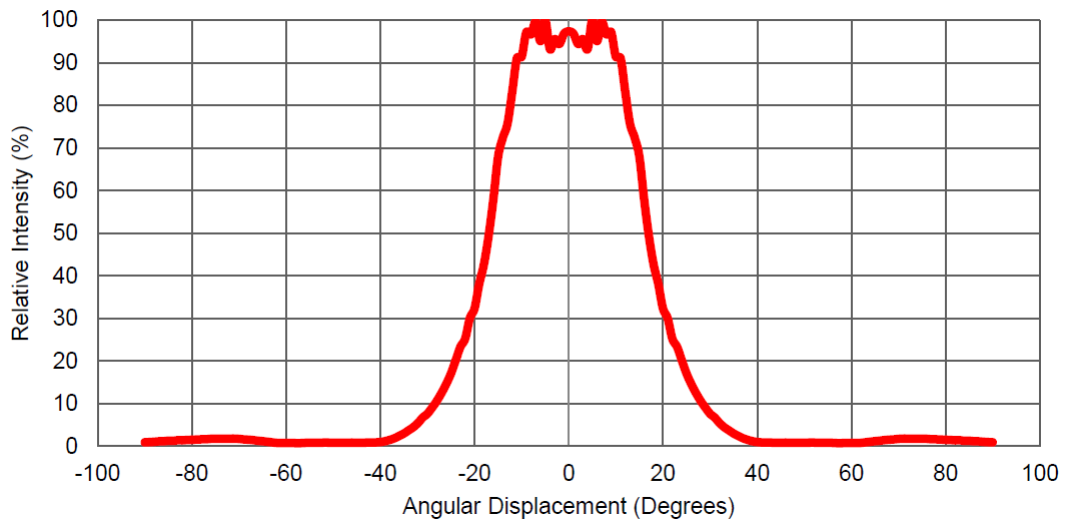

Typical Representative Spatial Radiation Pattern



■ **Reliability test:**

No	Item	Condition	Time/Cycle	Sample size
1	Steady State Operating Life of Room Temperature	25°C Operating	500 Hrs	10 pcs
2	Steady State Operating Life of Low Temperature -40°C	-40°C Operating	500 Hrs	10 pcs
3	Steady State Operating Life of Low Temperature 60°C	60°C Operating	500 Hrs	10 pcs
4	Steady State Operating Life of Low Temperature 85°C	65°C Operating	500 Hrs	10 pcs
5	Low temperature storage -40°C	-40°C Storage	500 Hrs	10 pcs
6	High temperature storage 100°C	100°C Storage	500 Hrs	10 pcs
7	Steady State Operating Life of High Humidity Heat 60°C/90%	60°C/90% Operating	500 Hrs	10 pcs
8	Steady State Pulse Operating Life Condition	25°C 10Hz duty=1/10 Operating	100 Cycle	10 pcs
9	Resistance to soldering heat on PCB (JEDEC MSL3)	pre-store @60°C, 60%RH for 52hrs Tslid max.=260 10sec	3 Times	10 pcs
10	Heat Cycle Test (JEDEC MRC)	25°C~65°C~-10°C, 90%RH, 24hr/1cycle	10 Cycle	10 pcs
11	Thermal shock	-40°C / 20min~ 5min~100°C /20min	100 Cycle	10 pcs

■ **Judgment Criteria:**

Item	Symbol	Test Condition	Judgment Criteria
Forward Voltage	Vf	100 mA	$\Delta Vf < 10\%$
Luminous Flux	Iv	100 mA	$\Delta Iv < 30\%$



Solder Profile:

-The recommended reflow soldering profile is as follows (temperatures indicated are as measured on the surface of the LED resin):

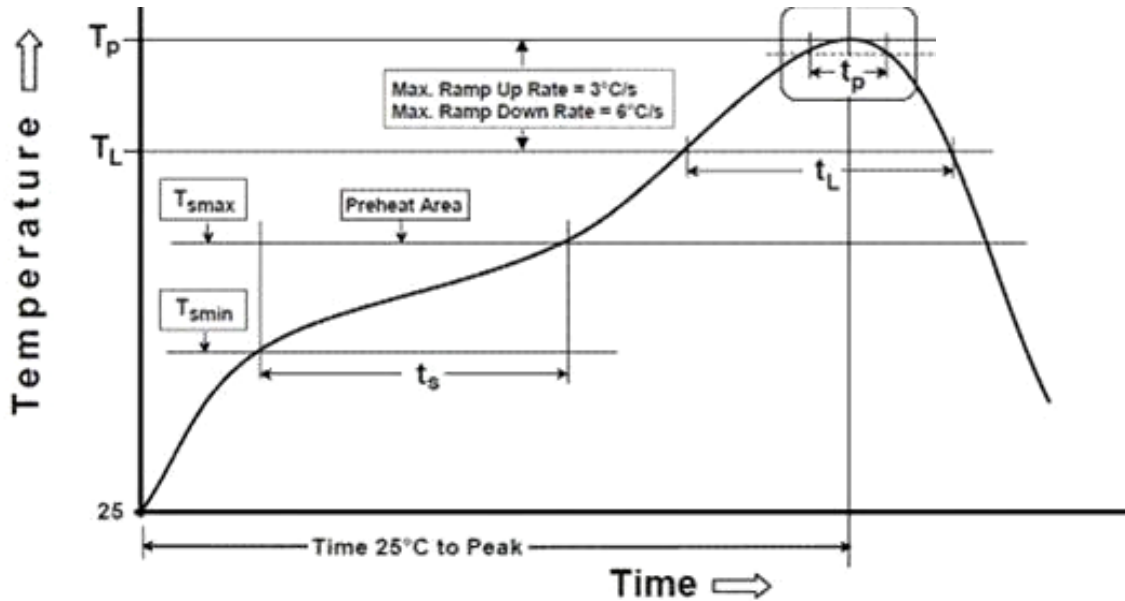

Profile Feature	Sn-Pb Eutectic Assembly	Pb-Free Assembly
Temperature Min(T_{smin})	100°C	150°C
Temperature Max(T_{smax})	150°C	200°C
Time(t_a) from (T_{smin} to T_{smax})	60-120 seconds	60-120 seconds
Ramp-up rate(T_L to T_P)	3°C/second max.	3°C/second max.
Liquidous Temperature(T_L)	183°C	217°C
Time(t_L) maintained above T_L	60-150 seconds	60-150 seconds
Peak package body temperature(T_P)	235°C	260°C
Time within 5°C of Actual Peak temperature (t_p)	20seconds*	30 seconds*
Ramp-down rate(T_P to T_L)	6°C/second max.	6°C/second max.
Time 25°C to peak temperature	6 minutes max.	8 minutes max.
* Tolerance for peak profile temperature (T_P) is defined as a supplier minimum and a user maximum.		



Taping & Packing:

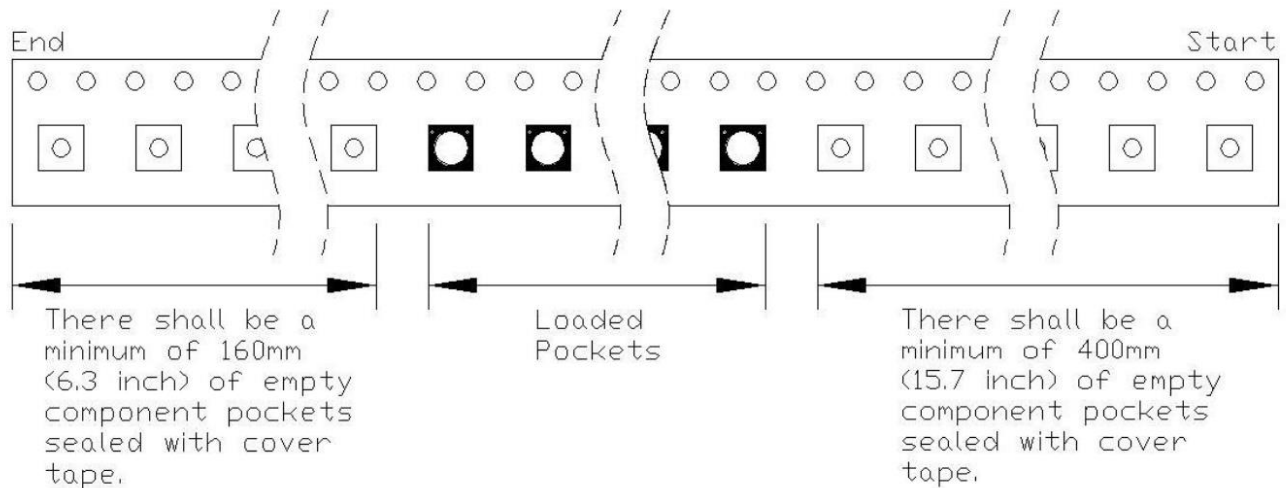
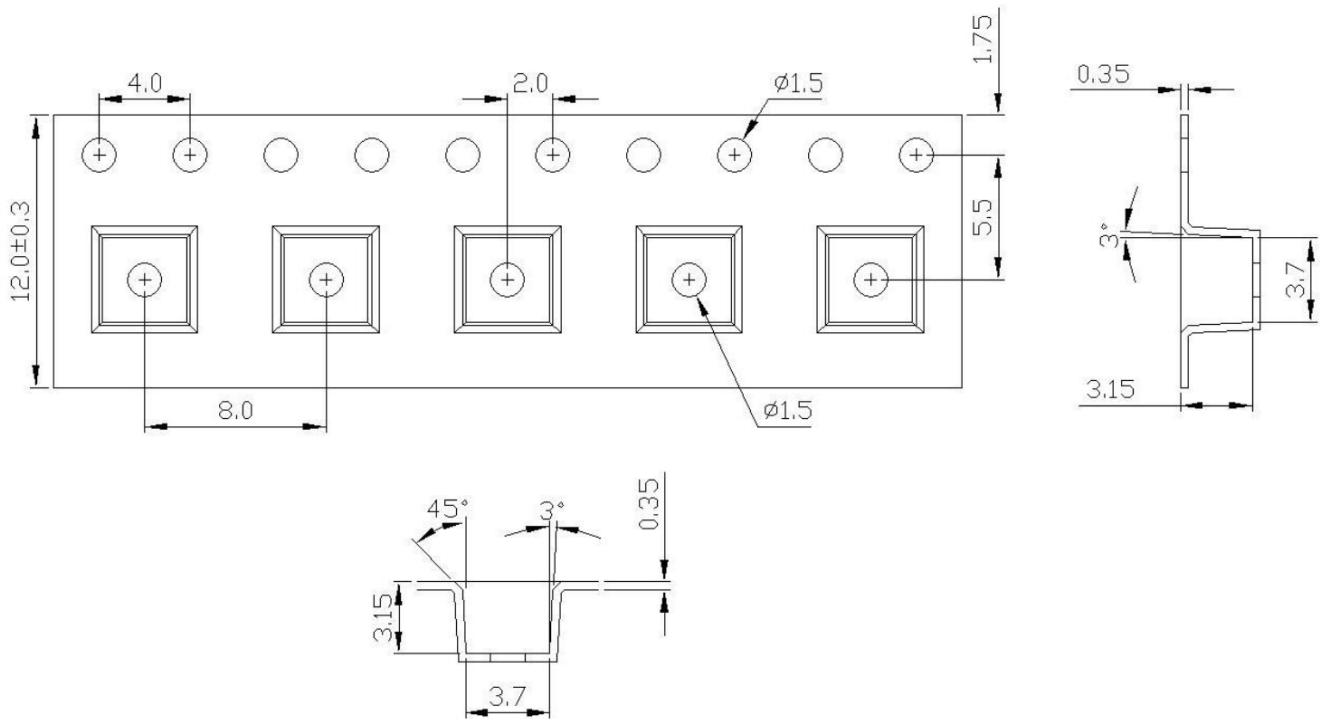

Notes:

1. Drawing not to scale.
2. All dimensions are in millimeters.
3. Unless otherwise indicated, tolerances are ± 0.10 mm.



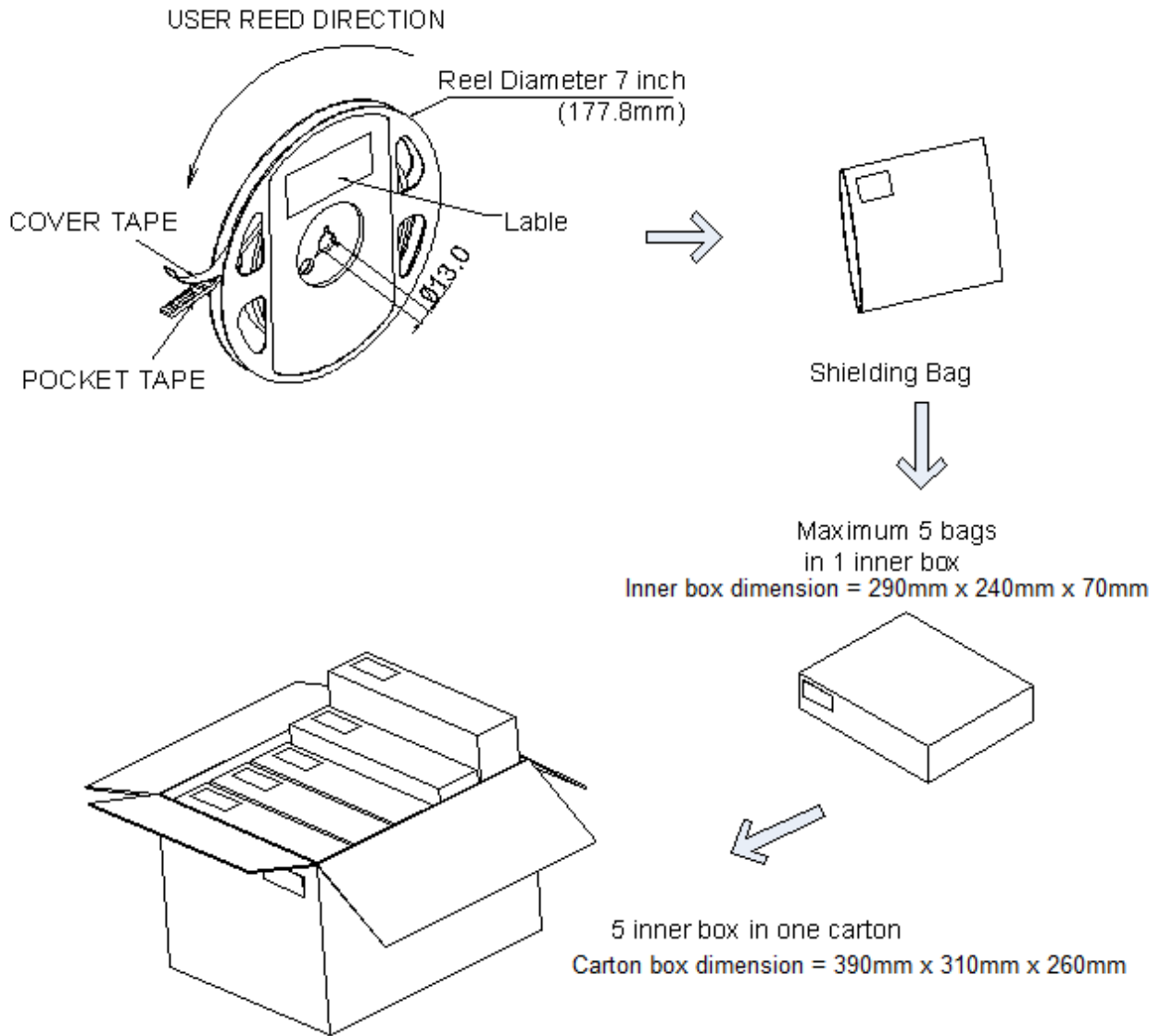

Labeling

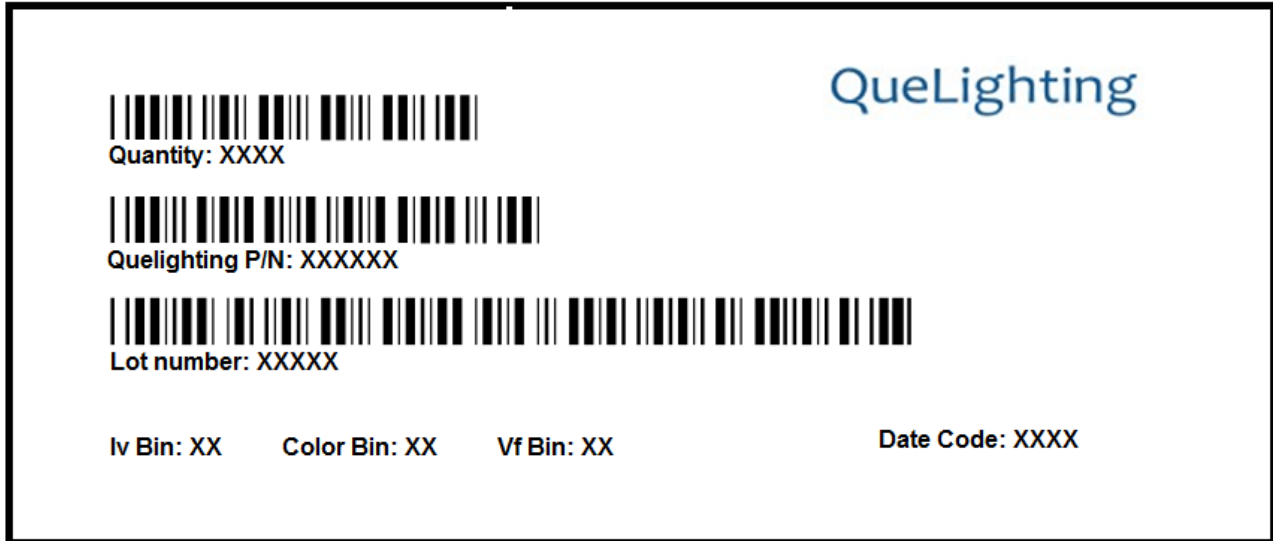

Ordering Information:

Part #	Multiple Quantities	Quantity per Reel
QLUV07N2DM		250, 500 pcs

Revision History:

Revision Date:	Changes:	Version #:
07-04-2020	Initial release	1.0

