



QPA9121

High Gain, 0.5 W Driver Amplifier

Product Overview

The QPA9121 is a wideband, high gain, and high peak power driver amplifier. With Qorvo’s GaAs HBT process, this amplifier provides 27dBm P3dB with 28dB gain at 2.6GHz. With a quiescent current of 95mA the part is well suited as a driver in a Tx path DPD loop, for m-MIMO applications.

The QPA9121 is internally match to 50Ω over the entire operating frequency band of 2.3-5.0 GHz and incorporates a shut-down function through the V_{PD} pin. The amplifier has been proven to provide excellent DPD correction with 5G signals as wide as 160MHz.

The QPA9121 is housed in a 16-pin 3X3mm SMT package and is footprint and pin-compatible to QPA9120.

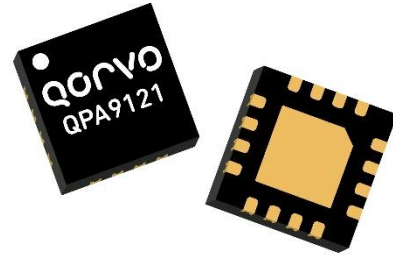

16 Pad 3 x 3 mm Laminate Package

Key Features

- 2.3–5.0 GHz Operational Frequency
- 50Ω Matched RF Input and Output
- +27 dBm P3dB
- 28 dB Gain at 2.6 GHz
- +5 V Single Supply, I_{cc} 95 mA
- DC Power Shutdown Feature

Functional Block Diagram

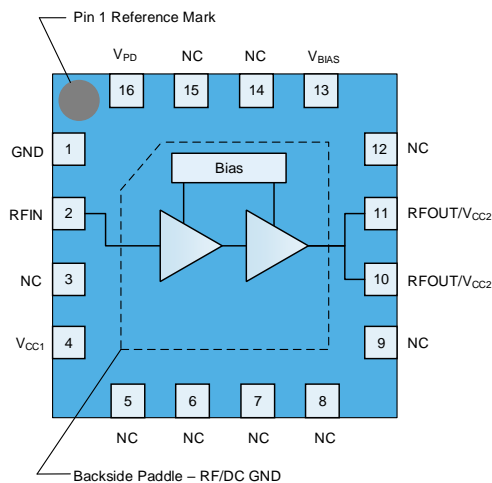

Top View

Applications

- 5G m-MIMO
- Mobile Infrastructure
- General Purpose Wireless
- TDD / FDD System

Ordering Information

Part No.	Description
QPA9121SR	100 pcs on 7" reel
QPA9121TR7	2500 pcs on 7" reel (standard)
QPA9121EVB-01	Evaluation Board

Absolute Maximum Ratings

Parameter	Rating
Storage Temperature	-65 to +150°C
T _{CASE}	-40 to +125°C
RF Input Power, ON state, CW, T=25 °C, 2:1 VSWR, In-band	+10 dBm
RF Input Power, OFF state, CW, T=25 °C, 2:1 VSWR, In-band	+10 dBm
Device Voltage (V _{CC1})	+6 V

Exceeding any one or a combination of the Absolute Maximum Rating conditions may cause permanent damage to the device. Extended application of Absolute Maximum Rating conditions to the device may reduce device reliability.

Recommended Operating Conditions

Parameter	Min	Typ	Max	Units
Device Voltage (V _{CC1})	+3.3	+5.0	+5.25	V
T _{CASE}	-40		+105	°C
T _j for >10 ⁶ hours MTTF			+218	°C

Electrical specifications are measured at specified test conditions. Specifications are not guaranteed over all recommended operating conditions.

Electrical Specifications

Parameter	Conditions ⁽¹⁾	Min	Typ	Max	Units
Operational Frequency Range		2300		5000	MHz
Gain	At 2.6 GHz	26.5	28	30	dB
	At 3.6 GHz	24	26	28	dB
Gain Flatness	Over 2.3-2.7GHz band		0.8		dB
	Over 3.3-3.8GHz band		1.1		dB
Input Return Loss			10		dB
Output Return Loss			10		dB
Reverse Isolation	ON state		40		dB
Forward Isolation	OFF state		40		dB
Output P1dB ⁽²⁾	At 2.6 GHz	22	25		dBm
	At 3.6 GHz	22	25.5		dBm
Output P3dB	At 2.6 GHz	25.4	26.7		dBm
	At 3.6 GHz	25.7	27		dBm
Output IP3	P _{out} =0 dBm/tone, Δf=1 MHz, 2.6GHz		32		dBm
	P _{out} =0 dBm/tone, Δf=1 MHz, 3.6GHz		30		dBm
ACPR	At 2.6 GHz, P _{out} =+15 dBm, 1C LTE 20MHz, 8dB PAR		-36	-34	dBc
	At 3.6 GHz, P _{out} =+15 dBm, 1C LTE 20MHz, 8dB PAR		-36	-33	dBc
Noise Figure	At 2.6 GHz		5		dB
Device Current, ON		50	95	130	mA
Device Current, OFF			2		mA
V _{PD} , Logic Low		0		0.63	V
V _{PD} , Logic High		1.17		V _{CC1}	V
Device ON or OFF Timing	50% Ctrl to 10/90% RF		0.46		μS
Thermal Resistance, θ _{Jc}	Junction to case		45		°C/W

Notes:

1. Test conditions unless otherwise noted: V_{CC1} = V_{CC2} = V_{bias} = +5.0 V, V_{PD} = +1.17 V, Temp = +25 °C, 50 Ω system.
2. Minimum specification listed is guaranteed by design. Not tested in production.

Evaluation Board (EVB) Layout Assembly - QPA9121EVB01

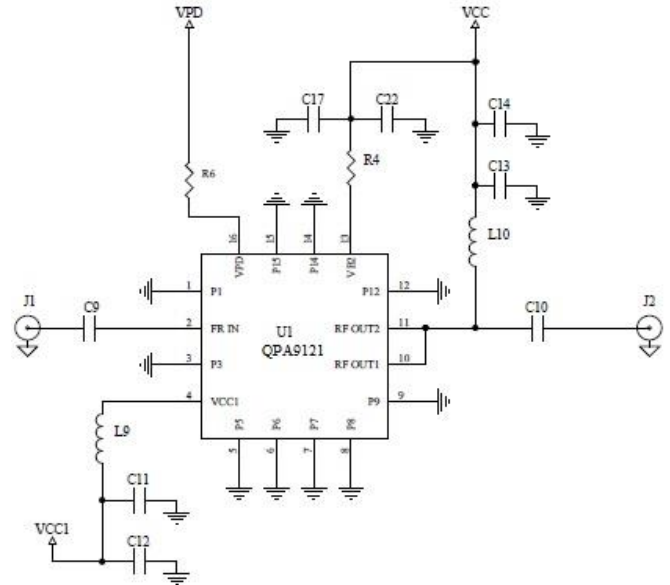
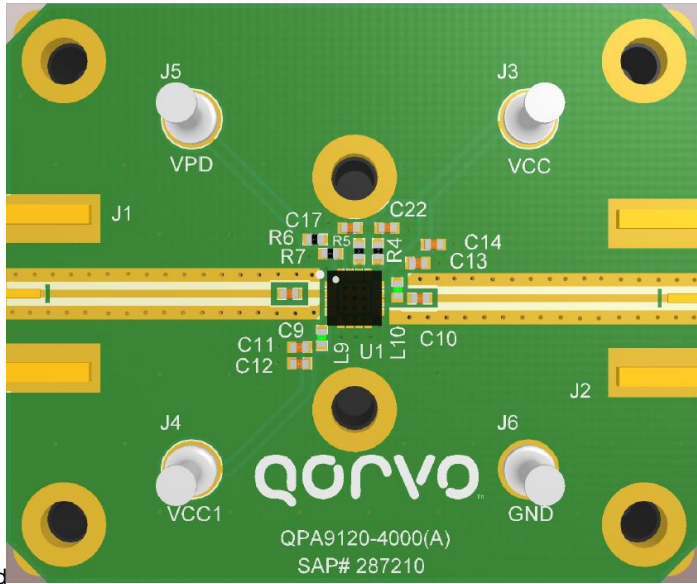

Notes:
1. Components shown on PCB layout but not on the schematic are not used.

Bill of Materials

Reference Des.	Value	Description	Manuf.	Part Number
n/a	-	Printed Circuit Board	Qorvo	
U1	-	High Gain Driver Amplifier	Qorvo	QPA9121
C9, C10	18 pF	CAP, 5%, 50V, C0G, 0402	Murata	GRM1555C1H180JA01D
C12, C14	1 μ F	CAP, 10V, X5R, CER, 0402	Various	
C11, C13, C17, C22	100 pF	CAP, 5%, 50V, C0G, 0402	Murata	GRM1555C1H101JA01D
R4	51 Ω	RES, 5%, 1/16W, 0402	Various	
R6	0 Ω	RES, 1/10W, 0402	Various	
L9	8.2 Ω	RES, 5%, 1/16W, 0402	Various	
L10	12 nH	IND, 5%, 0402	Coilcraft	0402CS-12NXJLW
J1, J2	-	Conn, SMA F STRT .062"	Cinch Connectivity	142-0701-851
R5, R7	DNP	n/a	n/a	n/a

Logic Table

Parameter, V_{PD}	High	Low
Device State	ON	OFF

Typical Performance

Parameter	Conditions	Typical Value			Units
Frequency		2600	3600	4900	MHz
Gain		28.1	26.4	25.7	dB
Input Return Loss		7.7	13.7	13.5	dB
Output Return Loss		15.2	13.4	14.3	dB
Output P3dB		26.6	27.0	26.8	dBm
Output IP3	Pout = +0 dBm/tone, Δf = 1 MHz	32.0	30.3	31.8	dBm
ACPR	Pout=+15 dBm, 1C LTE, 20MHz, 8.5dB PAR	-35.8	-34.6	-38.0	dBc
Device Current	V _{CC} and V _{CC1}	95			mA

Notes:

1. Test Conditions unless otherwise noted: V_{CC} and V_{CC1} on EVB = +5.0 V, I_{CC} = 95 mA, V_{PD} = +1.8 V, Temp.=+25 °C

Performance Plots – QPA9121EVB01

Test conditions unless otherwise noted: V_{CC} and V_{CC1} on EVB = +5.0 V, $I_{CC} = 95$ mA, $V_{PD} = +1.8$ V, Temp. = +25 °C

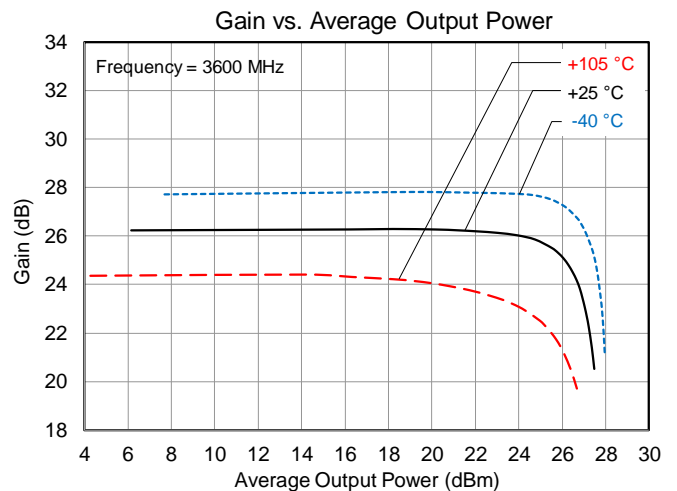
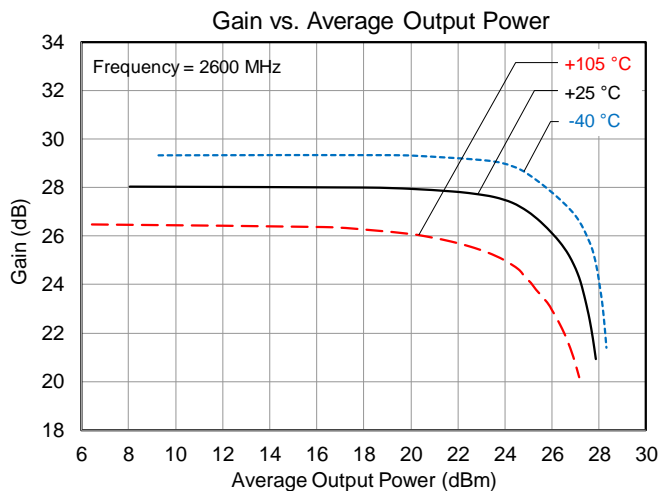
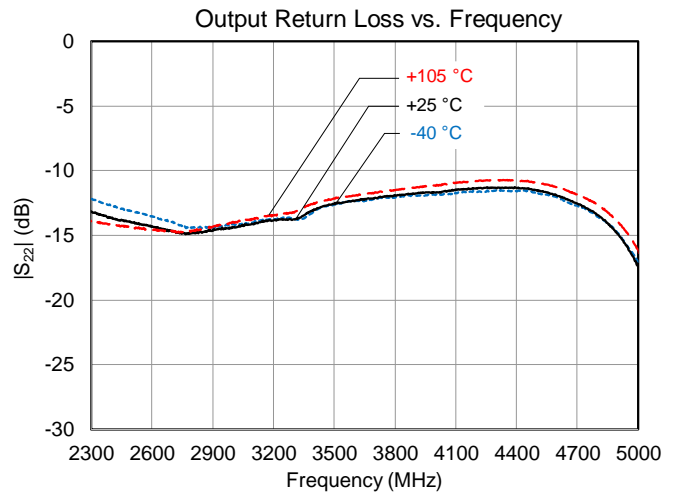
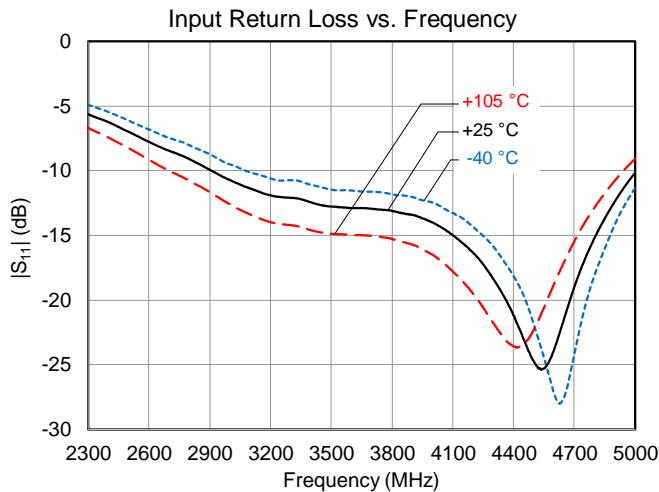
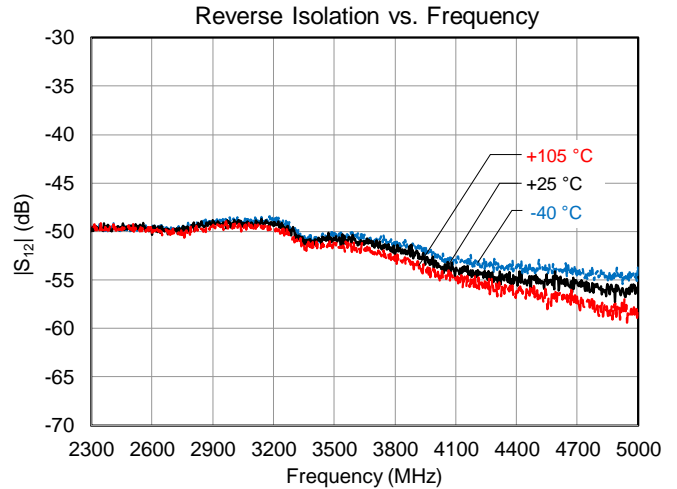
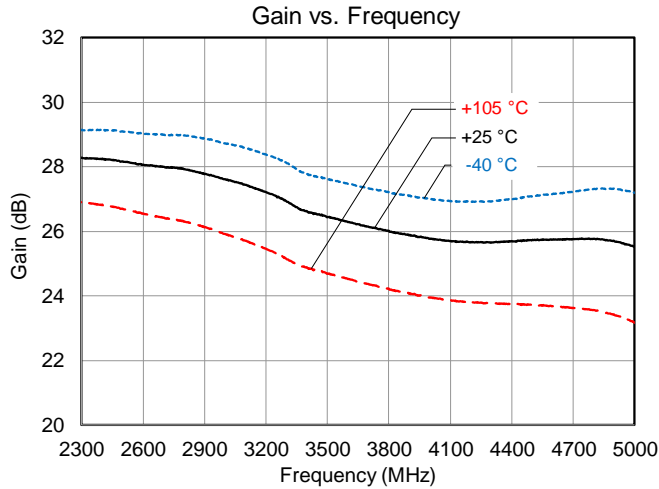

Performance Plots – QPA9121EVB01 (Continued)

Test conditions unless otherwise noted: V_{CC} and V_{CC1} on EVB = +5.0 V, $I_{CC} = 95$ mA, $V_{PD} = +1.8$ V, Temp. = +25 °C

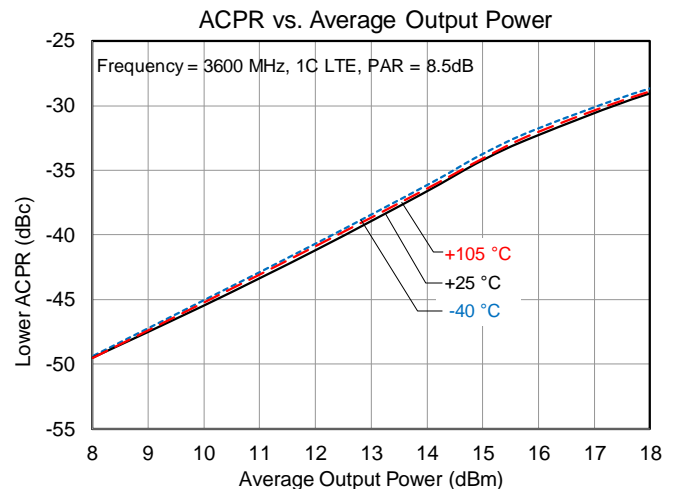
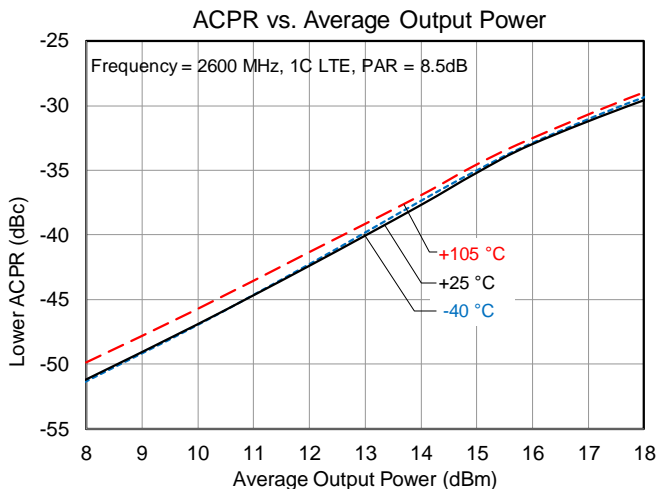
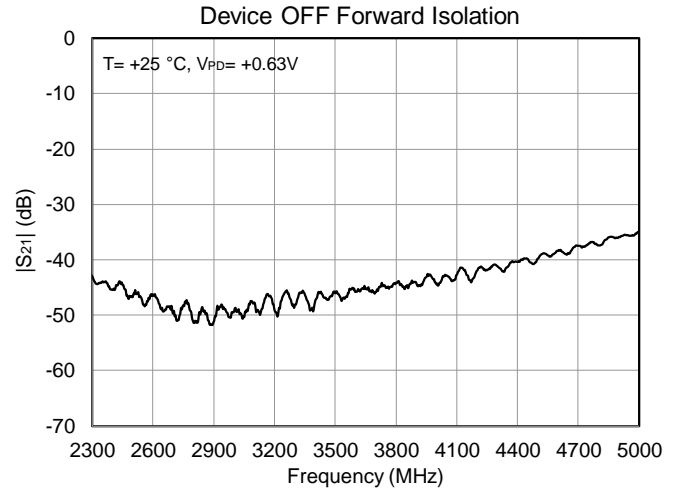
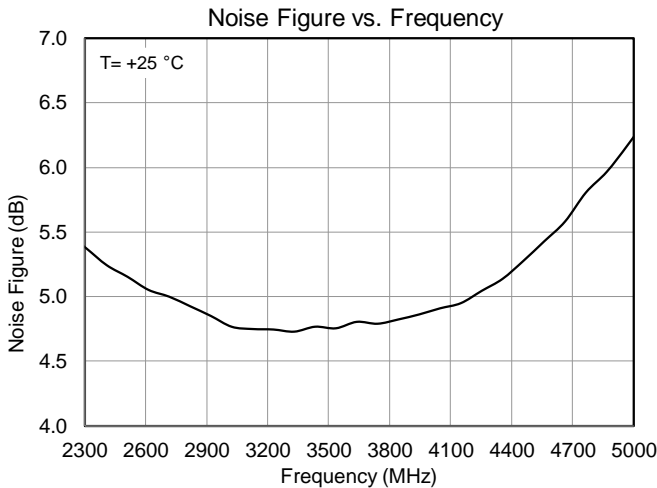
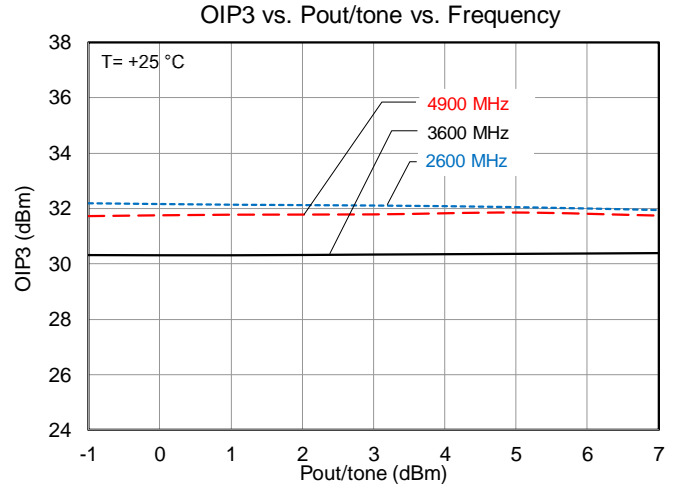
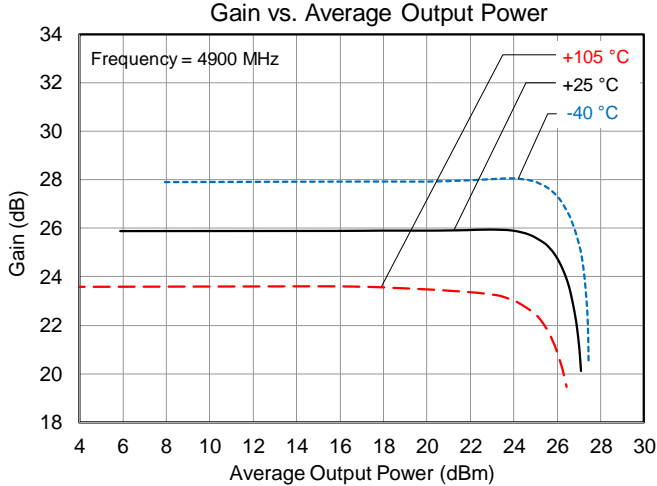

Performance Plots – QPA9121EVB01 (Continued)

Test conditions unless otherwise noted: V_{CC} and V_{CC1} on EVB = +5.0 V, $I_{CC} = 95$ mA, $V_{PD} = +1.8$ V, Temp. = +25 °C

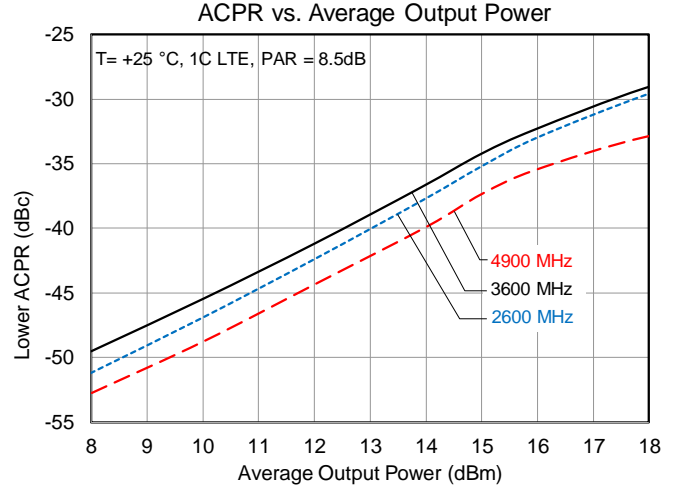
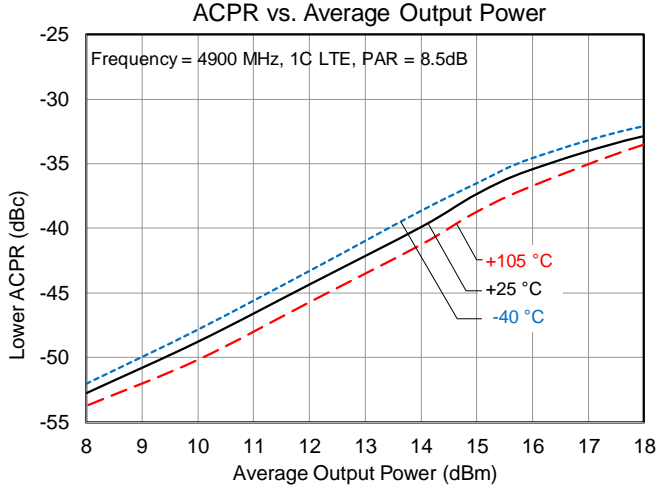

Pad Configuration and Description

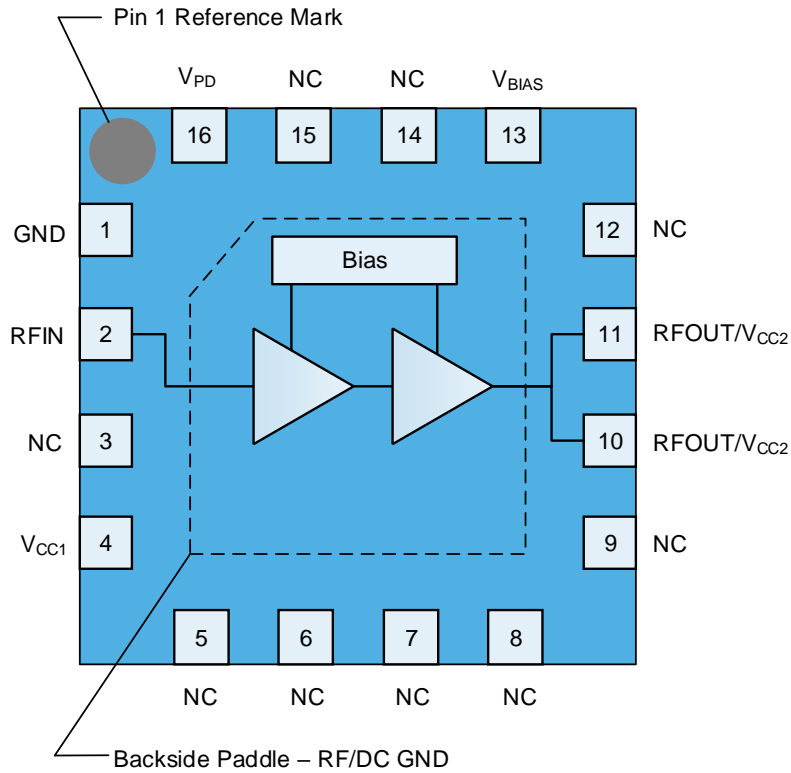

Top View

Pad No.	Label	Description
1	GND	Ground connection
2	RFIN	RF input. External DC block required.
3, 5, 6, 7, 8, 9, 12, 14, 15	NC	No electrical connection internally. It may be left floating or connected to ground. Land pads should be provided for PCB mounting integrity.
4	V _{CC1}	First stage DC supply.
10, 11	RFOUT / V _{CC2}	RF output and second stage DC supply. External choke and DC block capacitor required.
13	V _{BIAS}	Bias circuit supply voltage.
16	V _{PD}	PA on/off logic control.
Backside Paddle	GND	RF/DC ground connection. The back side of the package should be connected to the ground plan through as short of a connection as possible. PCB vias under the device as many as possible are recommended.

Package Marking and Dimensions

Marking: Part Number – A9121
Trace Code – XXXX up to 4 Characters assigned by sub-contractor

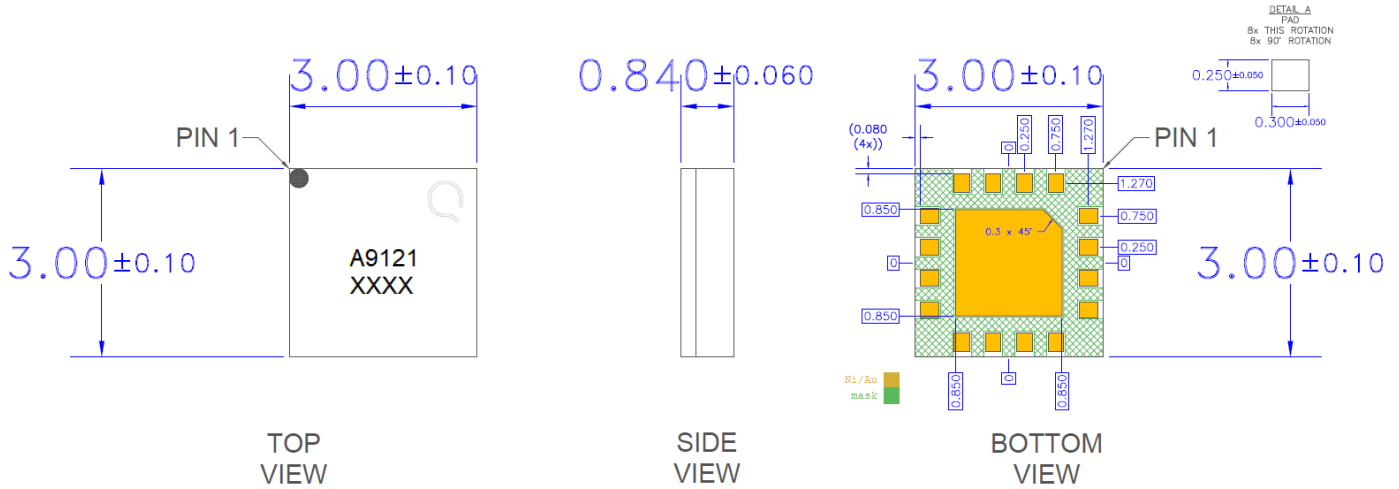

- Notes:
1. All dimensions are in millimeters. Angles are in degrees.
 2. The terminal #1 identifier and terminal numbering conform to SPE-000677.
 3. Contact plating: ENEPIG

Recommended PCB Layout Pattern

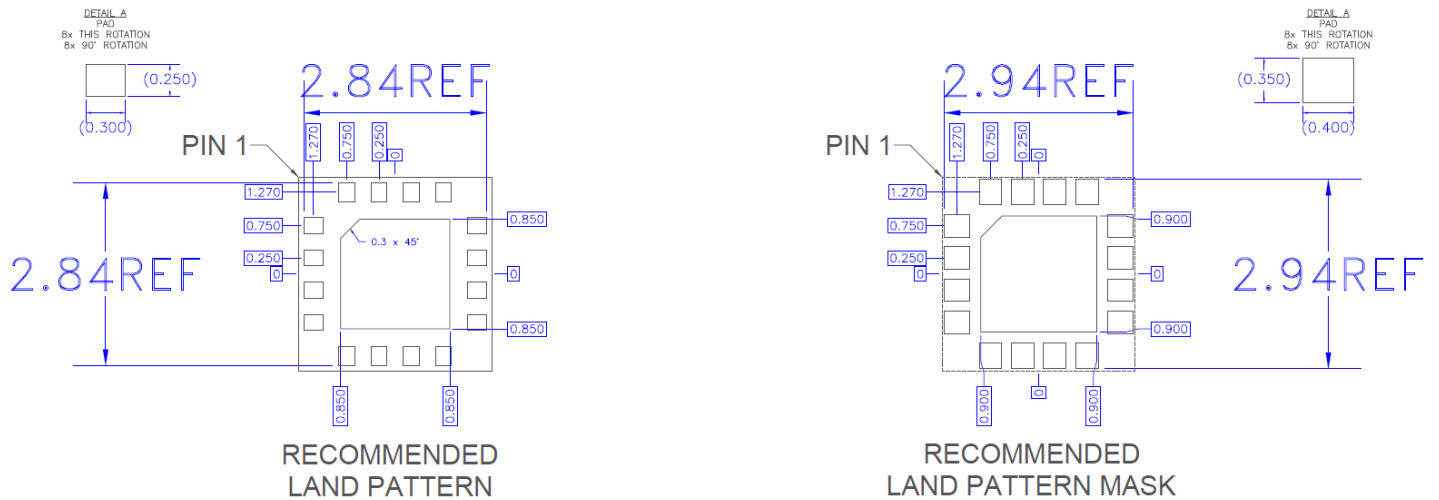

- Notes:
1. All dimensions are in millimeters. Angles are in degrees.
 2. Use 1 oz. copper minimum for top and bottom layer metal.
 3. Via holes are required under the backside paddle of this device for proper RF/DC grounding and thermal dissipation. We recommend a 0.35mm (#80/.0135") diameter bit for drilling via holes and a final plated thru diameter of 0.25 mm (0.01").
 4. Ensure good package backside paddle solder attach for reliable operation and best electrical performance.

Tape and Reel Information – Carrier and Cover Tape Dimensions

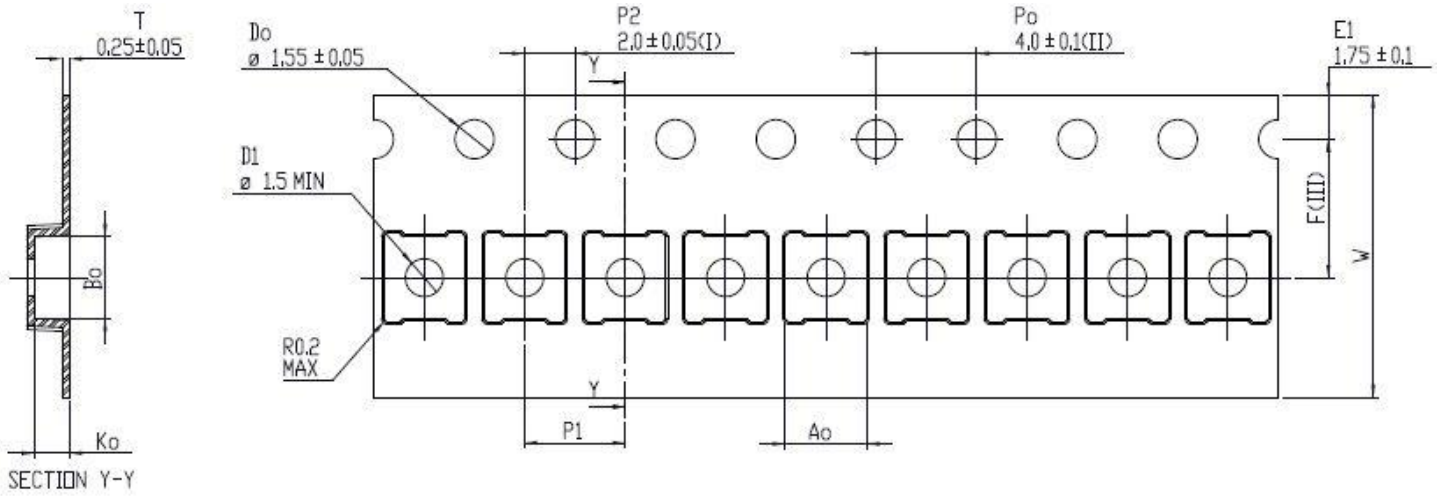

Feature	Measure	Symbol	Size (in)	Size (mm)
Cavity	Length	A0	0.128	3.25
	Width	B0	0.128	3.25
	Depth	K0	0.055	1.40
	Pitch	P1	0.157	4.00
Centerline Distance	Cavity to Perforation - Length Direction	P2	0.079	2.00
	Cavity to Perforation - Width Direction	F	0.217	5.50
Cover Tape	Width	C	0.362	9.20
Carrier Tape	Width	W	0.472	12.00

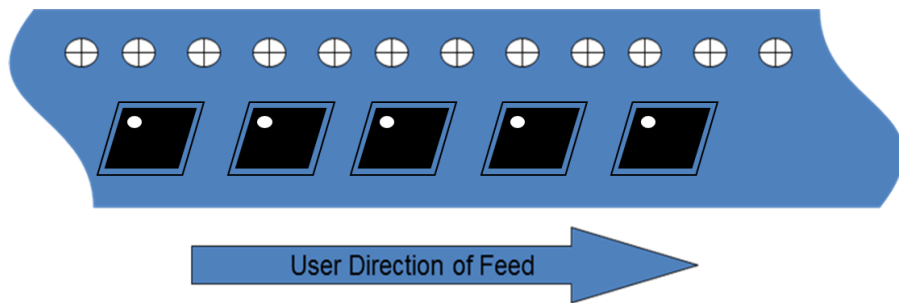

Tape and Reel Information – Reel Dimensions

Standard T/R size = 2,500 pieces on a 7" reel.

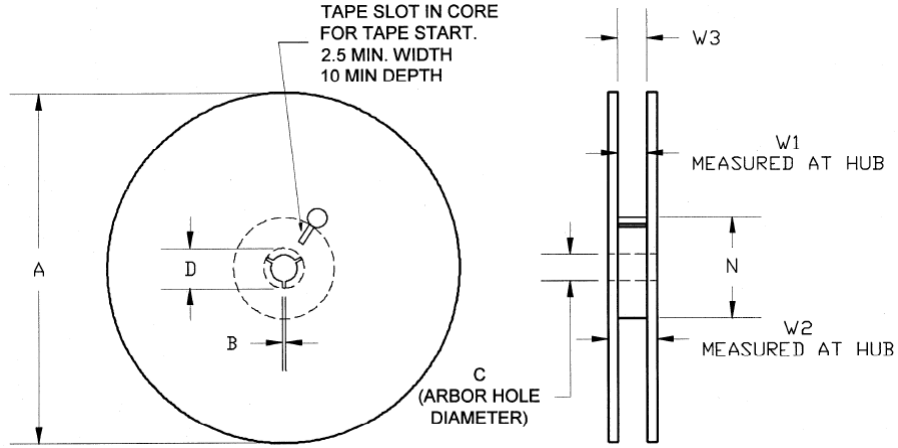

Feature	Measure	Symbol	Size (in)	Size (mm)
Flange	Diameter	A	6.969	177.0
	Thickness	W2	0.717	18.2
	Space Between Flange	W1	0.504	12.8
Hub	Outer Diameter	N	2.283	58.0
	Arbor Hole Diameter	C	0.512	13.0
	Key Slit Width	B	0.079	2.0
	Key Slit Diameter	D	0.787	20.0

Tape and Reel Information – Tape Length and Label Placement

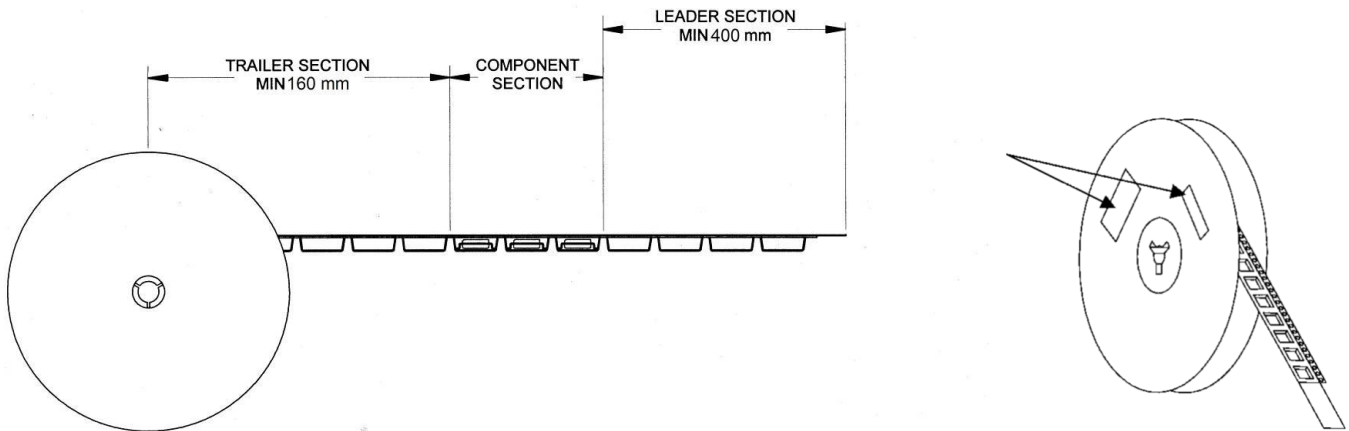

- Notes:
1. Empty part cavities at the trailing and leading ends are sealed with cover tape. See EIA 481-1-A.
 2. Labels are placed on the flange opposite the sprockets in the carrier tape.

Handling Precautions

Parameter	Rating	Standard
ESD – Human Body Model (HBM)	1C	ESDA / JEDEC JS-001-2017
ESD – Charged Device Model (CDM)	C3	JEDEC JESD22-C101F
MSL – Moisture Sensitivity Level	MSL3	IPC/JEDEC J-STD-020



Caution!
 ESD-Sensitive Device

Solderability

Compatible with both lead-free (260°C max. reflow temperature) and tin/lead (245°C max. reflow temperature) soldering processes. Solder profiles available upon request.

Contact plating: ENEPIG

RoHS Compliance

This part is compliant with 2011/65/EU RoHS directive (Restrictions on the Use of Certain Hazardous Substances in Electrical and Electronic Equipment) as amended by Directive 2015/863/EU.

This product also has the following attributes:

- Product uses RoHS Exemption 7c-I to meet RoHS Compliance requirements.
- Halogen Free (Chlorine, Bromine)
- Antimony Free
- TBBP-A (C₁₅H₁₂Br₄O₂) Free
- PFOS Free
- SVHC Free

Contact Information

For the latest specifications, additional product information, worldwide sales and distribution locations:

Web: www.qorvo.com

Tel: 1-844-890-8163

Email: customer.support@qorvo.com

Important Notice

The information contained herein is believed to be reliable; however, Qorvo makes no warranties regarding the information contained herein and assumes no responsibility or liability whatsoever for the use of the information contained herein. All information contained herein is subject to change without notice. Customers should obtain and verify the latest relevant information before placing orders for Qorvo products. The information contained herein or any use of such information does not grant, explicitly or implicitly, to any party any patent rights, licenses, or any other intellectual property rights, whether with regard to such information itself or anything described by such information. **THIS INFORMATION DOES NOT CONSTITUTE A WARRANTY WITH RESPECT TO THE PRODUCTS DESCRIBED HEREIN, AND QORVO HEREBY DISCLAIMS ANY AND ALL WARRANTIES WITH RESPECT TO SUCH PRODUCTS WHETHER EXPRESS OR IMPLIED BY LAW, COURSE OF DEALING, COURSE OF PERFORMANCE, USAGE OF TRADE OR OTHERWISE, INCLUDING THE IMPLIED WARRANTIES OF MERCHANTABILITY AND FITNESS FOR A PARTICULAR PURPOSE.**

Without limiting the generality of the foregoing, Qorvo products are not warranted or authorized for use as critical components in medical, life-saving, or life-sustaining applications, or other applications where a failure would reasonably be expected to cause severe personal injury or death.

Copyright 2024 © Qorvo, Inc. | Qorvo is a registered trademark of Qorvo, Inc.