

High Breakdown Voltage, Fully Depleted Series

Large Active Area Photodiodes

The Large Active Area High Speed Detectors can be fully depleted to achieve the lowest possible junction capacitance for fast response times. They may be operated at a higher reverse voltage, up to the maximum allowable value, for achieving even faster response times in nano seconds. The high reverse bias at this point, increases the effective electric field across the junction, hence increasing the charge collection time in the depleted region. Note that this is achieved without the sacrifice for the high responsivity as well as active area.

The Large Active Area Radiation Detectors can also be fully depleted for applications measuring high energy X-rays, γ -rays as well as high energy particles such as electrons, alpha rays and heavy ions. These types of radiation can be measured with two different methods. Indirect and direct.

Indirect High Energy Radiation Measurement:

In this method, the detectors are coupled to a scintillator crystal for converting high energy radiation into a detectable visible wavelength. The devices are mounted on a ceramic and covered with a clear layer of an epoxy resin for an excellent optical coupling to the scintillator. This method is widely used in detection of high energy gamma rays and electrons. This is where the X-UV devices fail to measure energies higher than 17.6 keV. The type and size of the scintillator can be selected based on radiation type and magnitude.

Direct High Energy Radiation Measurement:

Both PIN-RD100 and PIN-RD100A, can also be used without any epoxy resin or glass window for direct measurement of high energy radiation such as alpha rays and heavy ions. The radiation exhibits loss of energy along a linear line deep into the silicon after incident on the active area.

The amount of loss and the penetration depth is determined by the type and magnitude of the radiation. In order to measure completely the amount of radiation, the depletion layer should be deep enough to cover the whole track from the incident point to the stop point. This requires a high bias application to fully deplete the detector. In spite of the large active area as well as high bias voltage applications, the devices exhibit super low dark currents, low capacitances and low series resistances.



APPLICATIONS

- Large Active Area High Speed Detectors**
- Laser Guided Missiles
 - Laser Warning
 - Laser Range Finder
 - Laser Alignment
 - Control Systems

- Large Active Area Radiation Detectors**
- Electron Detection
 - Medical Instrumentation
 - High Energy Spectroscopy
 - Charged Particle Detection
 - High Energy Physics
 - Nuclear Physics

FEATURES

- Large Active Area High Speed Detectors**
- Large Active Area
 - Fully Depleteable
 - Fast Response
 - Ultra Low Dark Current
 - Low Capacitance

- Large Active Area Radiation Detectors**
- Large Active Area
 - Scintillator Mountable
 - Fully Depleteable
 - Ultra Low Dark Current
 - Low Capacitance
 - High Breakdown Voltage

In addition to their use in high energy particle detection, the PIN-RD100 and PIN-RD100A are also excellent choices for detection in the range between 350 to 1100 nm in applications where a large active area and high speed is desired.

These detectors can be coupled to a charge sensitive preamplifier or lownoise op-amp as shown in the opposite page. The configuration for indirect measurement is also shown with a scintillator crystal.

Typical Capacitance vs. Reverse Bias Voltage

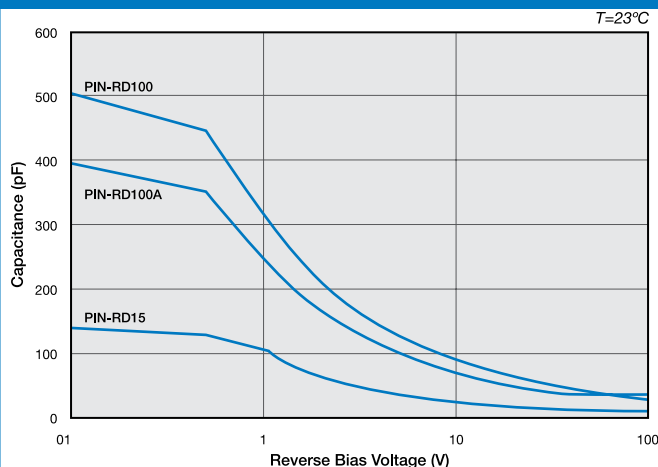

Typical Spectral Response

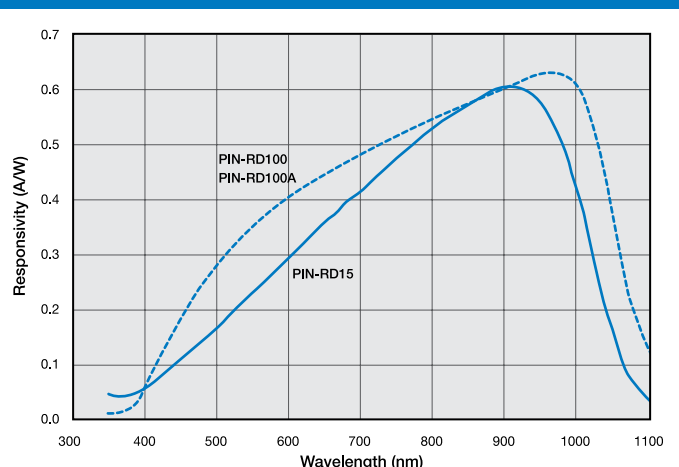

Fully Depleted Photodiodes

Typical Electro-Optical Specifications at $T_A=23^\circ\text{C}$

Model Number	Active Area		Peak Responsivity Wavelength (nm)	Responsivity (A/W)	Depletion Voltage	Dark Current (nA)		Capacitance (pF)		Rise Time (ns)	NEP (W/√Hz)	Reverse Voltage (V)	Temp.* Range (°C)		Package Style †
	Area (mm²)	Dimensions (mm)				900 nm	V	-100 V	-100 V				900 nm -100 V 50Ω	900nm -100V	
				typ.	typ.	typ.	max.	typ.	max.	typ.	typ.	max.			

Large Active Area, High Speed

PIN-RD07	7.1	3.00 φ	900	0.55	48	0.2	5.0	8.0	9.0	1.5	1.2 e-14	135	-40 ~ +100	-55 ~ +125	26 / TO-8
PIN-RD15	14.9	4.35 φ		0.58	55	1.0	30	14	16	3.0	2.5 e-14	140			
PIN-RD100	100	10 Sq	950	0.60	75	2	10	50	60	40	3.2 e-14	120	-20 ~ +60	-20 ~ +80	25 / Ceramic
PIN-RD100A	100	10 Sq			35	2 †	10 †	40 †	45 †	6	3.4 e-14	70			

Model Number	Active Area		Peak Responsivity Wavelength (nm)	Responsivity 900 nm	Capacitance (pF)	Shunt Resistance (GΩ)		NEP (W/√Hz)	Rise Time (ns)	Temp.* Range (°C)	Package Style †
	Area (mm²)	Dimensions (mm)				A/W	0 V				
				typ.	typ.	min.	typ.	typ.	typ.		

OSD35-LR Series

OSD35-LR-A	34.2	5.8 x 5.9	830	0.54	1300	2	3	5.6 e-15	---	-25 ~ +75	-45 ~ +100	25 / Ceramic
OSD35-LR-D	34.2	5.8 x 5.9	830	0.54	1300	0.1	0.3	1.8 e-14	---			

OSD-35-LR's ceramic packages come without window, instead the optically clear epoxy is used.

† Measured at $V_{\text{bias}} = -50\text{V}$

‡ For mechanical drawings please refer to pages 61 thru 73.

* Non-Condensing temperature and Storage Range, Non-Condensing Environment.

DIRECT DETECTION

For direct detection of high-energy particles, the pre-amplifier is a FET input op-amp, followed by one or more amplification stages, if necessary, or a commercial charge sensitive preamplifier. The counting efficiency is directly proportional to the incident radiation power. The reverse bias voltage must be selected as such to achieve the best signal-to-noise ratio. For low noise applications, all components should be enclosed in a metal box. Also, the bias supply should be either simple batteries or a very low ripple DC supply. The detector should also be operated in the photovoltaic mode.

Amplifier: OPA-637, OPA-27 or similar

R_f : 10 MΩ to 10 GΩ

R_s : 1 MΩ; Smaller for High Counting Rates

C_f : 1pF

C_D : 1pF to 10 μF

$$\text{OUTPUT } V_{\text{OUT}} = Q / C_f$$

Where Q is the Charge Created By One Photon or One Particle

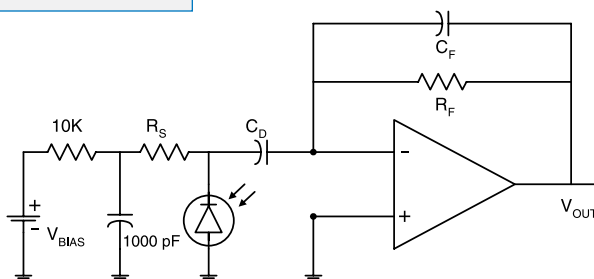

INDIRECT DETECTION (WITH SCINTILLATOR CRYSTAL)

The circuit is very similar to the direct detection circuit except that the photodiode is coupled to a scintillator. The scintillator converts the high-energy X-rays and/or X-rays into visible light. Suitable scintillators include CsI(TL), CdWO₄, BGO and NaI(TL). The amplifier should be a FET input op-amp, followed by one or more amplification stages, or a commercial charge sensitive preamplifier. The output voltage depends primarily on the scintillator efficiency and should be calibrated by using radioactive sources.

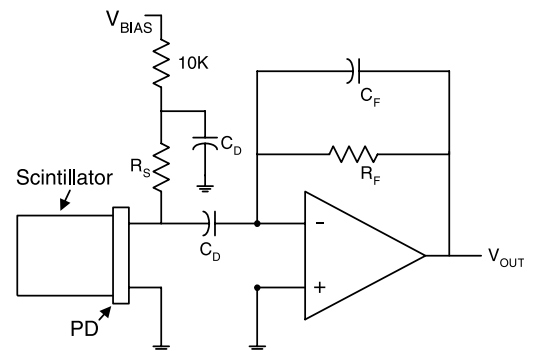

AVOID DIRECT LIGHT

Since the spectral response of silicon photodiode includes the visible light region, care must be taken to avoid photodiode exposure to high ambient light levels, particularly from tungsten sources or sunlight. During shipment from OSI Optoelectronics, your photodiodes are packaged in opaque, padded containers to avoid ambient light exposure and damage due to shock from dropping or jarring.

AVOID SHARP PHYSICAL SHOCK

Photodiodes can be rendered inoperable if dropped or sharply jarred. The wire bonds are delicate and can become separated from the photodiode's bonding pads when the detector is dropped or otherwise receives a sharp physical blow.

CLEAN WINDOWS WITH OPTICAL GRADE CLOTH / TISSUE

Most windows on OSI Optoelectronics photodiodes are either silicon or quartz. They should be cleaned with isopropyl alcohol and a soft (optical grade) pad.

OBSERVE STORAGE TEMPERATURES AND HUMIDITY LEVELS

Photodiode exposure to extreme high or low storage temperatures can affect the subsequent performance of a silicon photodiode. Storage temperature guidelines are presented in the photodiode performance specifications of this catalog. Please maintain a non-condensing environment for optimum performance and lifetime.

OBSERVE ELECTROSTATIC DISCHARGE (ESD) PRECAUTIONS

OSI Optoelectronics photodiodes, especially with IC devices (e.g. Photops) are considered ESD sensitive. The photodiodes are shipped in ESD protective packaging. When unpacking and using these products, anti-ESD precautions should be observed.

DO NOT EXPOSE PHOTODIODES TO HARSH CHEMICALS

Photodiode packages and/or operation may be impaired if exposed to CHLOROTHENE, THINNER, ACETONE, or TRICHLOROETHYLENE.

INSTALL WITH CARE

Most photodiodes in this catalog are provided with wire or pin leads for installation in circuit boards or sockets. Observe the soldering temperatures and conditions specified below:

Soldering Iron:	Soldering 30 W or less Temperature at tip of iron 300°C or lower.
Dip Soldering:	Bath Temperature: 260±5°C. Immersion Time: within 5 Sec. Soldering Time: within 3 Sec.
Vapor Phase Soldering:	DO NOT USE
Reflow Soldering:	DO NOT USE

Photodiodes in plastic packages should be given special care. Clear plastic packages are more sensitive to environmental stress than those of black plastic. Storing devices in high humidity can present problems when soldering. Since the rapid heating during soldering stresses the wire bonds and can cause wire to bonding pad separation, it is recommended that devices in plastic packages to be baked for 24 hours at 85°C.

The leads on the photodiode **SHOULD NOT BE FORMED**. If your application requires lead spacing modification, please contact OSI Optoelectronics Applications group at (310)978-0516 before forming a product's leads. Product warranties could be voided.



*Most of our standard catalog products are RoHS Compliant. Please contact us for details

Mechanical Drawings

Mechanical Specifications and Die Topography

1. Parameter Definitions:

A = Distance from top of chip to top of glass.

a = Photodiode Anode.

B = Distance from top of glass to bottom of case.

c = Photodiode Cathode

(Note: cathode is common to case in metal package products unless otherwise noted).

W = Window Diameter.

F.O.V. = Filed of View (see definition below).

2. Dimensions are in inches (1 inch = 25.4 mm).

3. Pin diameters are 0.018 ± 0.002 " unless otherwise specified.

4. Tolerances (unless otherwise noted)

General: $0.XX \pm 0.01$ "

$0.XXX \pm 0.005$ "

Chip Centering: ± 0.010 "

Dimension 'A': ± 0.015 "

5. Windows

All '**UV**' Enhanced products are provided with QUARTZ glass windows, 0.027 ± 0.002 " thick.

All '**XUV**' products are provided with removable windows.

All '**DLS**' PSD products are provided with A/R coated glass windows.

All '**FIL**' photoconductive and photovoltaic products are epoxy filled instead of glass windows.



$$F.O.V. = \tan^{-1} \left(\frac{W}{2A} \right)$$

For Further Assistance
Please Call One of Our Experienced
Sales and Applications Engineers

310-978-0516

OSI Optoelectronics
An OSI Systems Company

- Or -

visit our website at

www.osioptoelectronics.com

Mechanical Specifications

All units in inches. Pinouts are bottom view.

22 TO-5

Products:

XUV-005

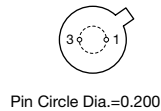
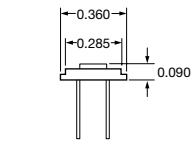

Pin Circle Dia.=0.200



23 TO-8

Products:

XUV-020
XUV-035

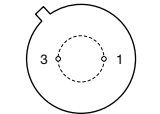
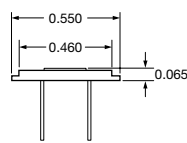

Pin Circle Dia.=0.295

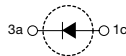

24 TO-8

Products:

PIN-DSIn-TEC

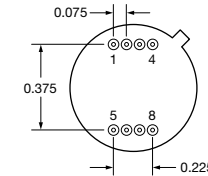
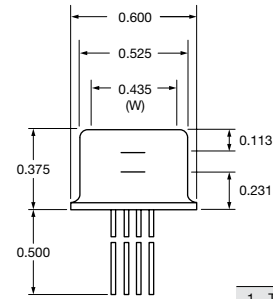

Pinout	
1	TEC (-)
2	Thermistor
3	Thermistor
4	TEC (+)
5	Top Silicon, Cathode
6	Top Silicon, Anode
7	Bottom InGaAs, Anode
8	Bottom InGaAs, Cathode

25 Special Ceramic / Plastic

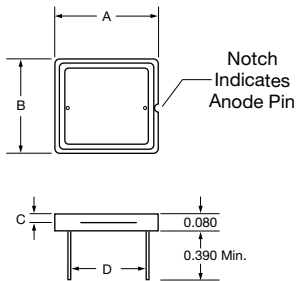

P/N	Dimensions			
	A	B	C	D
UV-005EQC	0.300	0.236	0.024	0.177
UV-035EQC	0.400	0.350	0.028	0.290
UV-100EQC	0.650	0.590	0.028	0.490
UV-005DQC	0.300	0.236	0.035	0.177
UV-035DQC	0.400	0.350	0.039	0.290
UV-100DQC	0.650	0.590	0.039	0.490
XUV-50C	0.650	0.590	0.027	0.490
XUV-100C	0.650	0.590	0.027	0.490
RD-100	0.650	0.590	0.027	0.490
RD-100A	0.650	0.590	0.027	0.490
UV-35P	0.390	0.345	0.050	0.275
OSD35-LR-A	0.390	0.350	---	0.290
OSD35-LR-D	0.390	0.350	---	0.290

Note: OSD35-prefix packages come with 0.31" (min.) leads

26 TO-8

Products:

RD-100
RD-100A
UV-35P
UV-005EQC
UV-035EQC
UV-100EQC
UV-005DQC
UV-035DQC
UV-100DQC
XUV-50C
XUV-100C
OSD35-LR-A
OSD35-LR-D

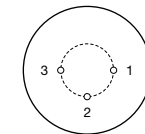
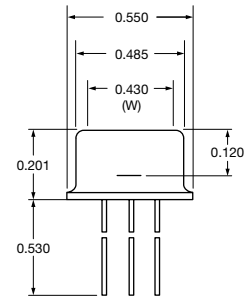

Pin Circle Dia.=0.295

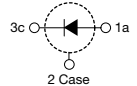

27 Special Plastic

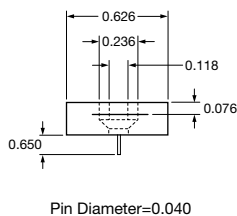
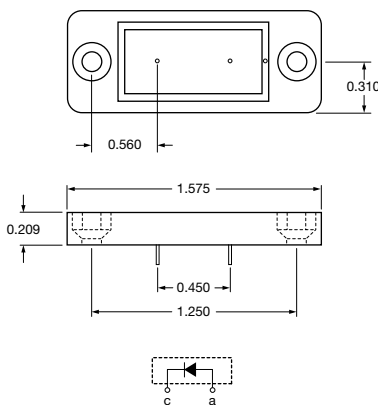

Pin Diameter=0.040



28 BNC

Products:

PIN-220D
PIN-220DP
PIN-220DP/SB

Products:

XUV-100

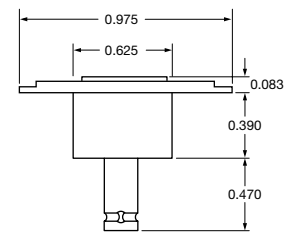

BNC Connector
Outer Contact = Cathode