

TF2 Series Mid Size Snap-acting Switches



Features/Benefits

- Broad range of operating forces
- Ratings up to 10 AMPS
- Wide variety of actuator styles
- Quick connect terminations

Typical Applications

- Motor controls
- Thermostatics
- Portable tools
- Air Conditioner



Specifications

CONTACT RATING: From low level* to 10 AMPS @125/250 V AC.
 ELECTRICAL LIFE: 10,000 cycles
 MECHANICAL LIFE: 1,000,000 cycles at 0.1A and 6A
 400,000 cycles at 10A
 INSULATION RESISTANCE: 1,000 M ohm min.
 DIELECTRIC STRENGTH: 1,500 Vrms min. @ sea level.
 OPERATING TEMPERATURE: -40°C to 125°C (-40°C to 85°C).
 OPERATING FORCE: From 18 to 330 grams at actuator button available.
 MOUNTING: Torque screws 2-5 in/lbs.

Materials

SWITCH HOUSING: Nylon 6/6
 ACTUATOR BUTTON: Nylon 6/6
 SPRING: Stainless Steel
 PIVOT: Brass Alloy
 MOVABLE CONTACTS: See electric rating page J-21
 MOVABLE BLADE: BeCu
 STATIONARY CONTACTS: See electric rating page J-21
 TERMINALS: Brass Alloy

NOTE: Specifications and materials listed above are switches with standard options. For information on specific and custom switches, consult Customer Service Center.

* Low Level=conditions where no arcing occurs during switching, i.e., 0.4 VA max. @ 20 V AC or DC max. Standard electrical life per UL 1054, rated for 6,000 operations.

Snap-acting

Build-A-Switch

To order, simply select desired option from each category and place in the appropriate box. For additional options not shown in catalog, consult Customer Service Center.



Series

TF2 SP, Mom.

Operating Force

- CC** 18 grams
- CF** 45 grams
- CG** 75 grams
- CH** 110 grams
- CJ** 170 grams
- EC** 230 grams
- EE** 330 grams

Electrical Rating Chart

OPTION CODE	61058-1	
F5	0.1A 125/250 V AC (T85) Min. 10,000 operations	0.1A 125/250 V AC μT125, 1E4
H8	6A 125/250 V AC (T85) Min. 10,000 operations	6A 125/250 V AC μT125, 1E4
K6	10A 125/250 V AC (T85) Min. 10,000 operations	10(4)A 125/250 V AC μT125, 1E4

see chart on following pages of compatible electrical ratings and operating force options

* Note: No UL & ENEC 15 safety for Termination option "60"

Mounting Style

- S** Standard
- V** Metric

Actuator

- P00** Pin plunger
- A10** Lever roller 12.5 mm
- A15** Lever roller 25.9 mm
- A20** Lever roller 12.5 mm
- A25** Lever roller 25.9 mm
- T10** Lever 14 mm
- T14** Simulated roller 24.5 mm
- T15** Lever 27.5 mm
- T16** Lever 31.7 mm
- T17** Lever 35 mm
- T20** Lever 14 mm
- T24** Simulated lever 24.5 mm
- T25** Lever 27.5 mm
- T26** Lever 31.7 mm
- T27** Lever 35 mm

Terminations

- 40** .187" quick connect
- 4A** .250" quick connect
- 5A** .250" off set quick connect
- 5B** .187" off set quick connect
- 60** Screw style *
- 10** Solder

Circuitry

- C** SPDT
- W** SPST N.C.
- Y** SPST N.O.

see chart on following pages for detailed information



TF2 Series Mid Size Snap-acting Switches

SERIES

TF2 MID SIZE SNAP-ACTING SWITCHES

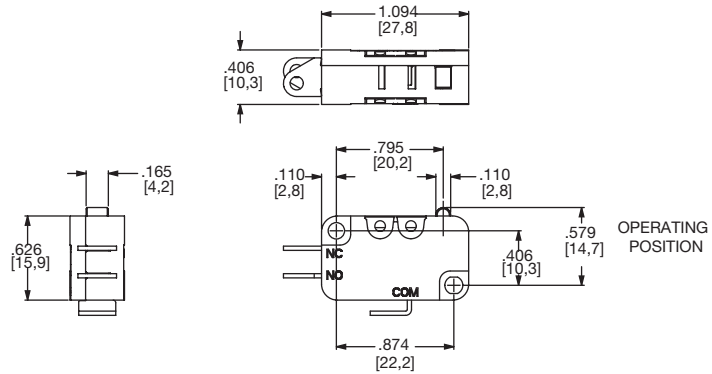

OPERATING FORCE

OPTION CODE	BASIC SWITCH OPERATING FORCE (grams)
CC	18
CF	45
CG	75
CH	110
CJ	170
EC	230
EE*	330

*Minimums may apply, consult Customer Service Center.



Snap-acting

ELECTRICAL RATING

OPTION CODE	CONTACT MATERIAL		MOVABLE CONTACT	STATIONARY CONTACT
	RoHS COMPLIANT *	RoHS COMPATIBLE *		
F5	Yes	Yes	Silver alloy	Silver alloy
H8	Yes	Yes		
K6	Yes	Yes		

* Note: See Technical Data section of this catalog for RoHS compliant and compatible definitions and specifications.

All models  

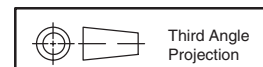

Third Angle Projection

Dimensions are shown: inches (mm)
Specifications and dimensions subject to change

TF2 Series Mid Size Snap-acting Switches

ELECTRICAL RATING

INTERNATIONAL RATING SYMBOLS	
μ	Microgap construction (less than 3 mm).
~	Alternating current.
T__	Maximum rated use temperature.
50E3	Cycles over 50,000 at rated current.
10E3	Cycles over 10,000 at rated current.
10(3)	Current Rating: First number represents resistive rating; second number represents inductive (motor) rating.

ELECTRICAL RATING	AMPS (REF.)	OPERATING FORCE						
		CC (18)	CF (45)	CG (75)	CH (110)	CJ (170)	EC (230)	EE (330)
F5	0.1	•	•	•	•	•	•	X
H8	6	X	•	•	•	•	•	•
K6	10	X	X	X	•	•	•	•

• AVAILABLE
X NOT AVAILABLE

Snap-acting

All models  

Consult Customer Service center for availability and delivery of nonstandard ratings.

* Low Level=conditions where no arcing occurs during switching, i.e., 0.4 VA max. @ 20 V AC or DC max.

MOUNTING STYLE

S STANDARD
For 4-40 screw size

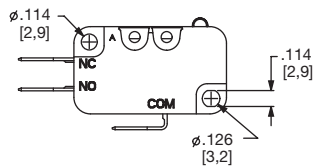

TF2 SWITCH WITH TYPE 40 (.187 QC) TERMINALS AND P00 ACTUATOR SHOWN

NOTE: TORQUE MOUNTING SCREWS 2-5 IN/LBS.

V Metric
For 3 mm screw size

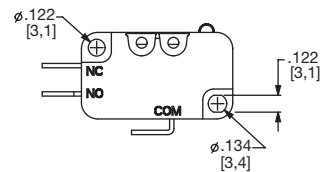

TF2 SWITCH WITH TYPE 10 (SOLDER) TERMINALS AND P00 ACTUATOR SHOWN

NOTE: TORQUE MOUNTING SCREWS 2-5 IN/LBS.

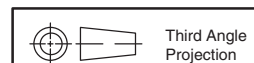

Third Angle
Projection

Dimensions are shown: inches (mm)
Specifications and dimensions subject to change

ACTUATOR

OPTION CODE	FIG	DIM. A	DIM. B	DIM. C	DIM. D	DIM. E
P00	2	.795 (20,2)	-	.578 ± .019 (14,70 ± 0,05)	0.068 (1,72)	-
A10	1	.822 (20,9)	.33 (8,4)	.816 ± .050 (20,73 ± 1,27)	.106 (2,70)	∅.19 (∅ 4,8)
A15	1	1.35 (34,3)	.33 (8,4)	.816 ± .059 (20,73 ± 1,5)	.165 (4,20)	∅.19 (∅ 4,8)
A20	1	1.05 (26,8)	.56 (14,3)	.816 ± .050 (20,73 ± 1,27)	.183 (4,65)	∅.19 (∅ 4,8)
A25	1	1.58 (40,2)	.56 (14,3)	.816 ± .086 (20,73 ± 2,2)	.366 (9,30)	∅.19 (∅ 4,8)
T10	3	.882 (22,39)	.33 (8,4)	.602 ± .020 (15,3 ± 0,50)	.110 (2,80)	-
T14	4	1.295 (32,9)	.33 (8,4)	.737 ± .059 (18,72 ± 1,5)	.216 (5,50)	∅.275 (∅ 7,0)
T15	3	1.405 (35,69)	.33 (8,4)	.600 ± .059 (15,24 ± 1,5)	.232 (5,90)	-
T16	3	1.58 (40,01)	.33 (8,4)	.604 ± .068 (15,35 ± 1,75)	.196 (5,0)	-
T17	3	1.708 (43,39)	.33 (8,4)	.603 ± .062 (15,33 ± 1,57)	.216 (5,50)	-
T20	3	1.11 (28,3)	.56 (14,3)	.604 ± .045 (15,34 ± 1,14)	.204 (5,20)	-
T24	4	1.527 (38,8)	.56 (14,3)	.742 ± .090 (18,84 ± 2,29)	.342 (8,70)	∅.275 (∅ 7,0)
T25	3	1.631 (41,43)	.56 (14,3)	.609 ± .090 (15,47 ± 2,3)	.381 (9,70)	-
T26	3	1.811 (46,00)	.56 (14,3)	.616 ± .125 (15,65 ± 3,18)	.389 (9,90)	-
T27	3	1.94 (49,3)	.56 (14,3)	.598 ± .150 (15,2 ± 3,8)	.433 (11,0)	-

NOTE: Switch characteristics chart on following page.

Lever Roller

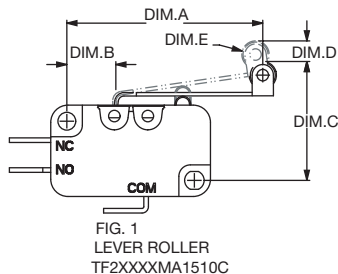

Pin Roller

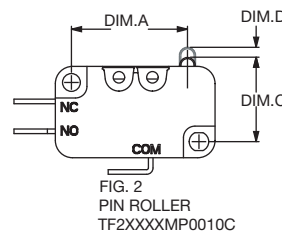

Lever

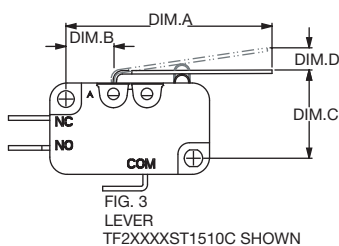

Simulated Roller

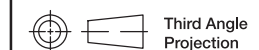
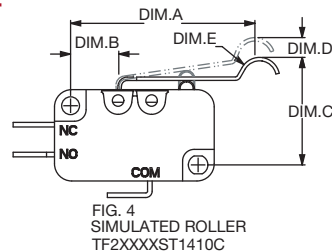

Dimensions are shown: inches (mm)
Specifications and dimensions subject to change

TF2 Series Mid Size Snap-acting Switches

ACTUATOR

Lever Type		CC	CF	CG	CH Grams	CJ	EC	EE	Pre-Travel max. mm	Max Differential max. mm	Over Travel Min. mm
P00	OF	18	45	75	110	170	230	330	1.72	0.4	0.8
	RF	3	7	14	20	34	42	60			
T10	OF	18	45	75	110	170	230	330	2.8	0.5	0.6
	RF	-	6	11	17	25	35	50			
T20	OF	8	27	43	50	85	120	175	5.2	0.9	1.55
	RF	-	3	5	7	13	17	25			
T14	OF	10	28	43	65	110	140	205	5.5	1.1	1.4
	RF	-	3	5	8	14	17	31			
T24	OF	7	16	24	35	56	70	100	8.7	1.7	3.2
	RF	-	-	-	4	5	9	12			
A10	OF	20	55	80	110	170	230	330	2.7	0.45	0.6
	RF	-	5	11	16	28	31	45			
A20	OF	8	35	55	70	100	120	175	4.65	0.8	1.4
	RF	-	3	5	7	14	18	28			
A15	OF	8	30	45	65	100	125	180	4.2	1.25	1.6
	RF	-	-	5	7	12	16	25			
A25	OF	7	20	30	40	51	65	90	9.3	1.8	2.8
	RF	-	-	-	-	6	8	9			
T17	OF	16	25	35	50	80	100	140	5.5	1.2	0.55
	RF	-	2	4	6	11	14	20			
T27	OF	13	18	24	32	45	55	90	11	2.3	3.6
	RF	-	-	2	3	5	7	10			
T16	OF	15	17	32	55	85	110	150	5	1.05	1.8
	RF	-	-	4	6	12	15	22			
T26	OF	10	12	18	35	45	65	90	9.9	2.05	3.6
	RF	-	-	2	4	6	8	11			
T15	OF	18	22	37	50	86	125	180	5.9	1	1.6
	RF	-	3	5	9	14	17	24			
T25	OF	5	16	25	30	51	65	90	9.7	2.2	3.1
	RF	-	-	3	4	6	8	11			

HIGH FORCE, LOW MOTION PIVOT POSITION

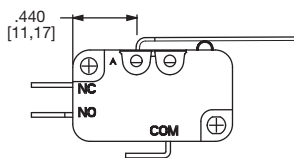

Available with actuators A10, A15, T10, T13, T14, T15, T16 and T18.

LOW FORCE, HIGH MOTION PIVOT POSITION

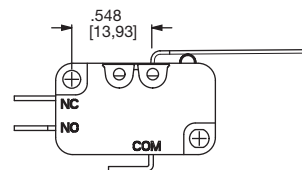

Available with actuators A20, A25, T20, T23, T24, T25, T26, and T28.

NOTE: Lever actuator options are available in either of two pivot positions. Levers located in the forward pivot position have lower forces and higher motions. Levers located in the rear pivot position have higher forces and lower motions.

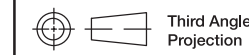

Third Angle Projection

Dimensions are shown: mm

Specifications and dimensions subject to change



TF2 Series Mid Size Snap-acting Switches

TERMINATIONS

40 .187" QUICK CONNECT

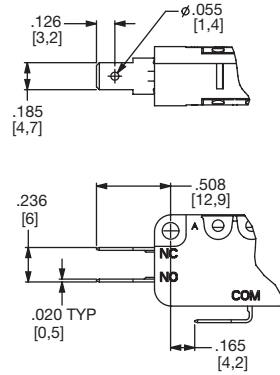

4A .250" QUICK CONNECT

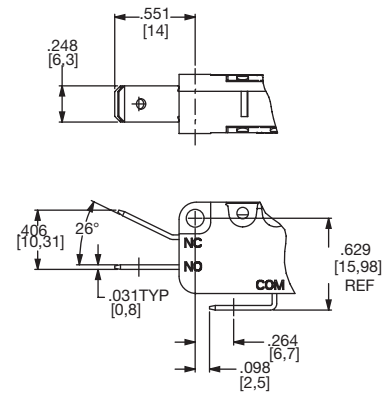

5A .250" OFF SET QUICK CONNECT

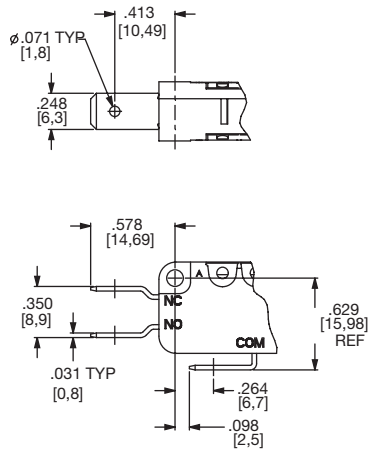

5B .187" OFF SET QUICK CONNECT

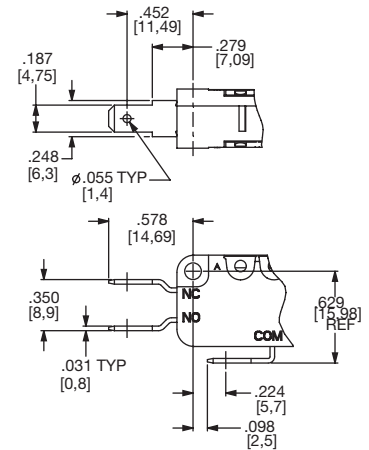

60 SCREW STYLE

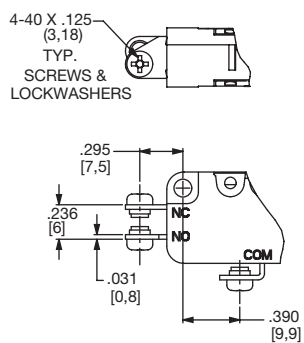

10 SOLDER

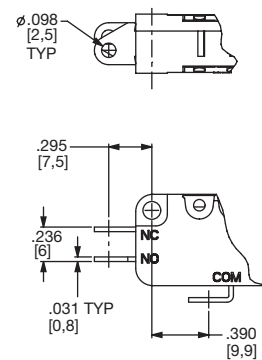

Snap-acting

CIRCUITRY

- C** SPDT (Single Pole, Double Throw)
- W** SPST N.C. (Single Pole, Single Throw, Normally Closed)
- Y** SPST N.O. (Single Pole, Single Throw, Normally Open)

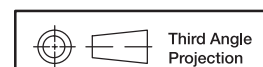

Third Angle Projection
Dimensions are shown: inches (mm)
Specifications and dimensions subject to change

