

Features

- Supply Voltage: 3 V to 36 V
- Low Supply Current: Maximum 1000 μ A per channel
- Differential Input Voltage Range to Supply Rail, can Work as Comparator
- Input Rail to $-V_s$, Rail to Rail Output
- Fast Response: 3.5-MHz Bandwidth, 15-V/ μ s Slew Rate, 100-ns Overload Recovery
- Low Offset Voltage:
 - ± 2 mV Maximum at 25°C,
 - ± 4 mV Maximum at -40°C to 125°C
- Excellent EMIRR: 60 dB at 900 MHz
- -40°C to 125°C Operation Temperature Range
- Qualified for Automotive Applications with AEC-Q100 Reliability Test

Description

The TP226x series of amplifiers are the newest high supply voltage amplifiers with low offset, low power, and stable high-frequency response. They incorporate 3PEAK's proprietary and patented design techniques to achieve very good AC performance with 3.5-MHz bandwidth, 15-V/ μ s slew rate, and low distortion while drawing only typical 700 μ A of quiescent current per amplifier. The input common-mode voltage range extends to V_- , and the outputs swing rail-to-rail. The TP226x family can be used as plug-in replacements for many commercially available op-amps to reduce power and improve input/output range and performance.

The combination of features makes the TP226x ideal choices for industrial control, motor control, portable audio amplification, sound ports, and other consumer audio.

Applications

- Motor Control
- Industrial Control
- Automotive

Pin Configuration

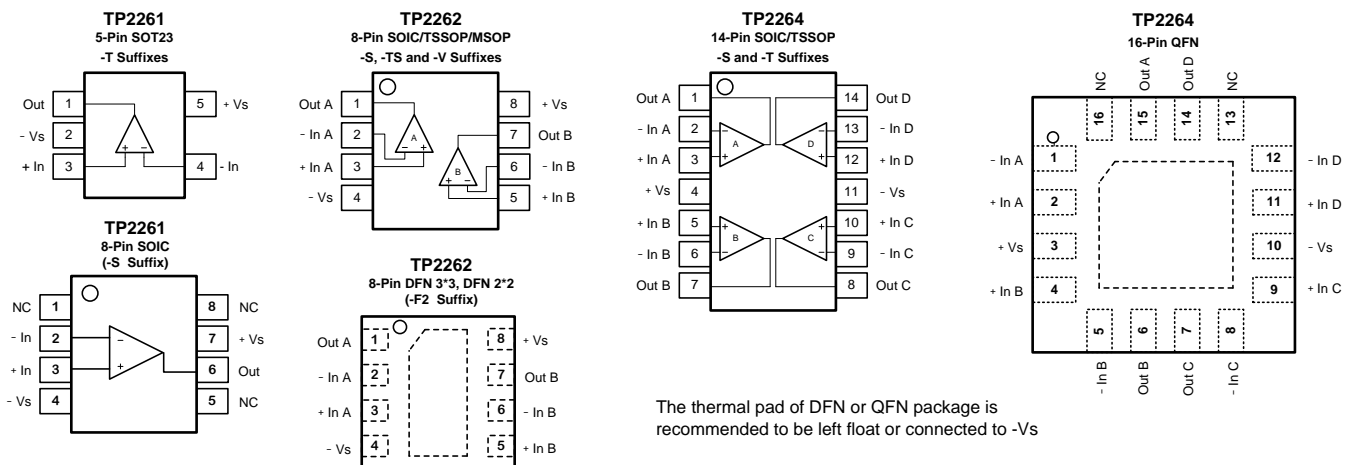

Table of Contents

Features.....	1
Applications	1
Description.....	1
Pin Configuration	1
Table of Contents	2
Revision History.....	2
Order Information.....	3
Absolute Maximum Ratings ^{Note 1}	4
ESD Rating	4
Thermal Information	4
Electrical Characteristics.....	5
Typical Performance Characteristics	7
Tape and Reel Information.....	12
Package Outline Dimensions	13
SOT23-5	13
SOIC-8.....	14
SOIC-14.....	15

Revision History

Revision	Notes
Rev.Pre.0	Pre-Version
Rev.Pre.1	Fixed specification
Rev.Pre.2	Added part number: TP2261L1-S5TR-S
Rev.A.0	Initial Version

Order Information

Order Number	Operating Temperature Range	Package	Marking Information	MSL	Transport Media, Quantity
TP2261L1-S5TR-S	-40 to 125°C	SOT23-5	226	3	Tape and Reel, 3000
TP2262L1-SO1R-S	-40 to 125°C	SOP8	TP2262	1	Tape and Reel, 4000
TP2264L1-SO2R-S ⁽¹⁾	-40 to 125°C	SOP14	TP2264	1	Tape and Reel, 2500

Note 1: For future products, contact 3PEAK factory for more information and samples.

Absolute Maximum Ratings ⁽¹⁾

Parameters	Rating
Supply Voltage, (+V _S)– (-V _S)	40 V
Input Voltage	(-V _S) – 0.3 to (+V _S) + 0.3
Differential Input Voltage	(+V _S) - (-V _S)
Input Current: +IN, –IN ^{Note 2}	±10mA
Output Short-Circuit Duration ^{Note 3}	Infinite
Maximum Junction Temperature	150°C
Operating Temperature Range	–40 to 125°C
Storage Temperature Range	–65 to 150°C
Lead Temperature (Soldering, 10 sec)	260°C

Note 1: Stresses beyond those listed under Absolute Maximum Ratings may cause permanent damage to the device. Exposure to any Absolute Maximum Rating condition for extended periods may affect device reliability and lifetime.

Note 2: The inputs are protected by ESD protection diodes to each power supply. If the input extends more than 300 mV beyond the power supply, the input current should be limited to less than 10 mA.

Note 3: A heat sink may be required to keep the junction temperature below the absolute maximum. This depends on the power supply voltage and how many amplifiers are shorted. Thermal resistance varies with the amount of PC board metal connected to the package. The specified values are for short traces connected to the leads.

ESD Rating

Symbol	Parameter	Condition	Minimum Level	Unit
HBM	Human Body Model ESD	ANSI/ESDA/JEDEC JS-001	2	kV
CDM	Charged Device Model ESD	ANSI/ESDA/JEDEC JS-002	1	kV

Thermal Information

Package Type	θ_{JA}	θ_{JC}	Unit
SOT23-5	250	81	°C/W
SOP8	158	43	°C/W
SOP14	120	36	°C/W

Electrical Characteristics

All test conditions: $V_S = (+V_S) - (-V_S) = 30\text{ V}$, $T_A = 25^\circ\text{C}$, $R_L = 10\text{ k}\Omega$ to $V_S/2$, unless otherwise noted.

Symbol	Parameter	Conditions	T_A	Min	Typ	Max	Unit
Power Supply							
V_S	Supply Voltage Range			3		36	V
I_Q	Quiescent Current per Amplifier	$V_S = 30\text{ V}$, TP2261			1000	1500	μA
			-40°C to 125°C			2500	μA
		$V_S = 5\text{ V}$, TP2261			850	1300	μA
			-40°C to 125°C			2000	μA
		$V_S = 30\text{ V}$, TP2262/TP2264			700	1000	μA
			-40°C to 125°C			2000	μA
$V_S = 5\text{ V}$, TP2262/TP2264			600	850	μA		
	-40°C to 125°C			1500	μA		
PSRR	Power Supply Rejection Ratio	$V_S = 3\text{ V}$ to 36 V		95	120		dB
			-40°C to 125°C	80			dB
Input Characteristics							
V_{OS}	Input Offset Voltage	$V_S = 30\text{ V}$, $V_{CM} = 0\text{ V}$ to 28 V		-2	0.1	2	mV
			-40°C to 125°C	-4		4	mV
		$V_S = 30\text{ V}$, $V_{CM} = 28.5\text{ V}$		-3		3	mV
			-40°C to 125°C	-5		5	mV
		$V_S = 5\text{ V}$, $V_{CM} = 2.5\text{ V}$		-2	0.1	2	mV
			-40°C to 125°C	-4		4	mV
$V_{OS\text{ TC}}$	Input Offset Voltage Drift		-40°C to 125°C		2		$\mu\text{V}/^\circ\text{C}$
I_B	Input Bias Current			-250	25	250	pA
		-40°C to 125°C			1	10	nA
I_{OS}	Input Offset Current ⁽¹⁾			-250	25	250	pA
		-40°C to 125°C			1	10	nA
I_{IN}	Differential Input Current	$V_S = 36\text{ V}$, $V_{ID} = 36\text{ V}$			10		nA
			-40°C to 125°C			100	
C_{IN}	Input Capacitance	Differential Mode			5		pF
		Common Mode			5		pF
A_V	Open-loop Voltage Gain			105	120		dB
		-40°C to 125°C		90			dB
V_{CMR}	Common-mode Input Voltage Range			(V-)		(V+) - 1.5	V
CMRR	Common Mode Rejection Ratio	$V_{CM} = 0\text{ V}$ to 28 V		105	130		dB
			-40°C to 125°C	90			dB

Output Characteristics								
V _{OH}	Output Swing from Positive Rail	R _{LOAD} = 10 k Ω to V _S /2			200	300	mV	
			-40°C to 125°C			600		mV
		R _{LOAD} = 2 k Ω to V _S /2			1.1	1.4		V
			-40°C to 125°C				2.8	
V _{OL}	Output Swing from Negative Rail	R _{LOAD} = 10 k Ω to V _S /2			200	300	mV	
			-40°C to 125°C			600		mV
		R _{LOAD} = 2 k Ω to V _S /2			0.8	1		V
			-40°C to 125°C				2	
I _{sc}	Output Short-Circuit Current			25	32		mA	
		-40°C to 125°C		10			mA	
AC Specifications								
GBW	Gain-Bandwidth Product				3.5		MHz	
SR	Slew Rate	G = 1, 10 V step			15		V/ μ s	
		Open Loop		9	15		V/ μ s	
			-40°C to 125°C	6				V/ μ s
t _{OR}	Overload Recovery				100		ns	
t _s	Settling Time, 0.1%	G = -1, 10 V step			0.8		μ s	
	Settling Time, 0.01%				1		μ s	
PM	Phase Margin	V _S = 36 V, R _L =10 K, C _L =100 pF			60		°	
GM	Gain Margin	V _S = 36 V, R _L =10 K, C _L =100 pF			15		dB	
Noise Performance								
E _N	Input Voltage Noise	f = 0.1 Hz to 10 Hz			1.7		μ V _{RMS}	
e _N	Input Voltage Noise Density	f = 1 kHz			30		nV/ \sqrt Hz	
i _N	Input Current Noise	f = 1 kHz			2		fA/ \sqrt Hz	
THD+N	Total Harmonic Distortion and Noise	f = 1 kHz, G = 1, R _L = 10 k Ω , V _{OUT} = 6 V _{RMS}			0.0005		%	

(1) Provided by bench test and design simulation.

Typical Performance Characteristics

$V_S = \pm 15V$, $V_{CM} = 0V$, $R_L = 10k\Omega$, unless otherwise specified.

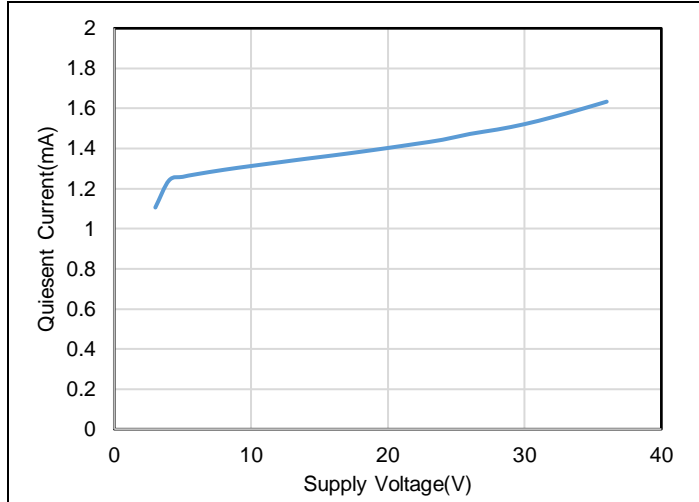

Figure 1. Quiescent Current vs. Supply Voltage, 2ch TP2262

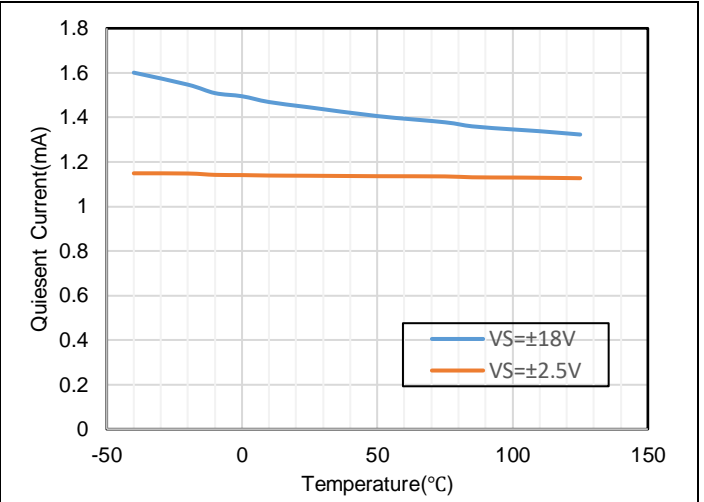

Figure 2. Quiescent Current vs. Temperature, 2ch TP2262

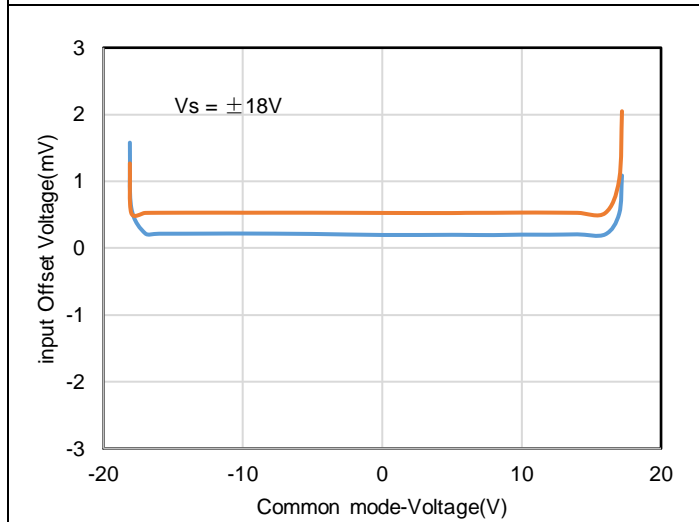

Figure 3. Offset Voltage vs. Common Mode Voltage

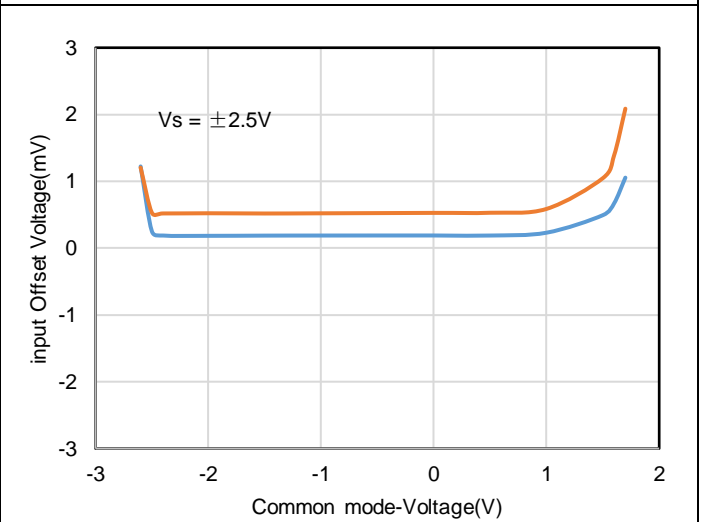

Figure 4. Offset Voltage vs. Common Mode Voltage

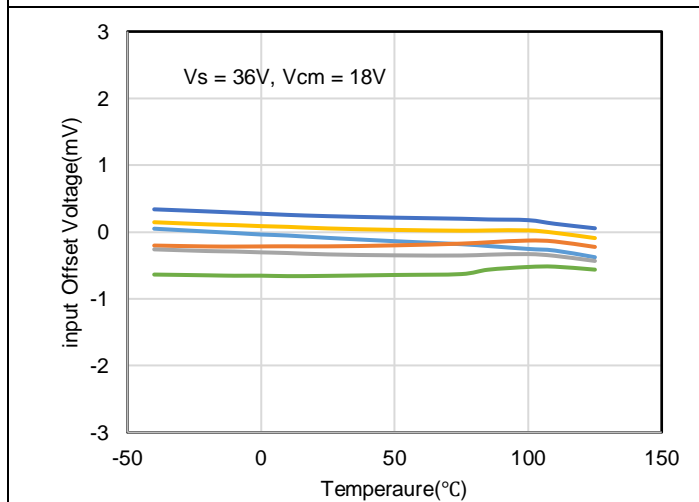

Figure 5. V_{OS} vs. Temperature

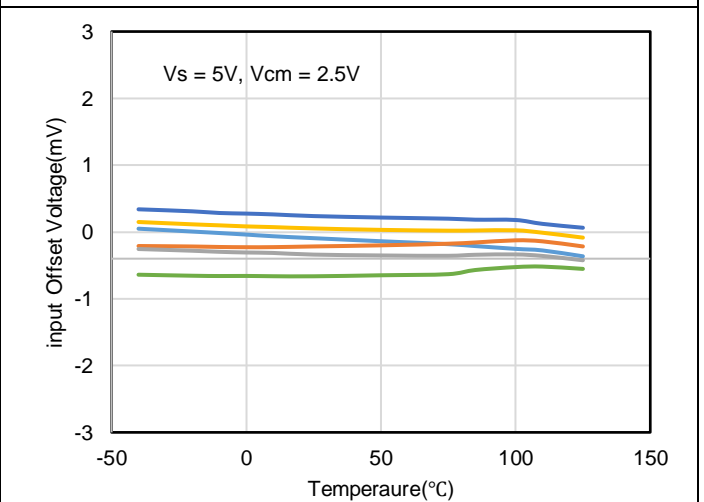

Figure 6. V_{OS} vs. Temperature

$V_s = \pm 15V$, $V_{CM} = 0V$, $R_L = 10k\Omega$, unless otherwise specified.

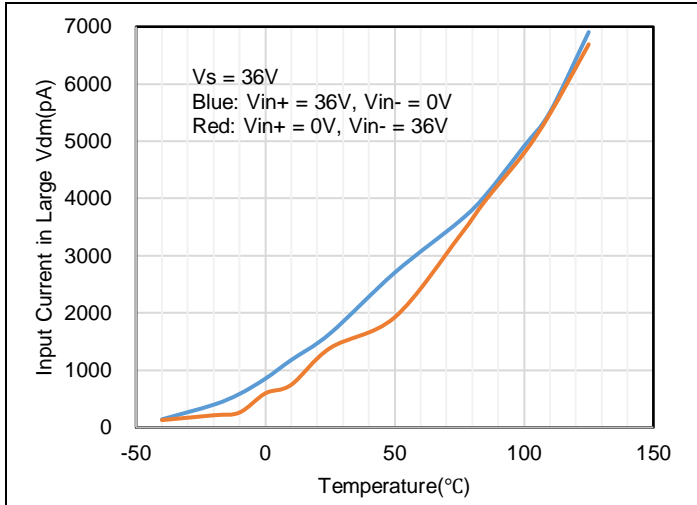

Figure 7. Input Current in Large Vdm vs. Temperature

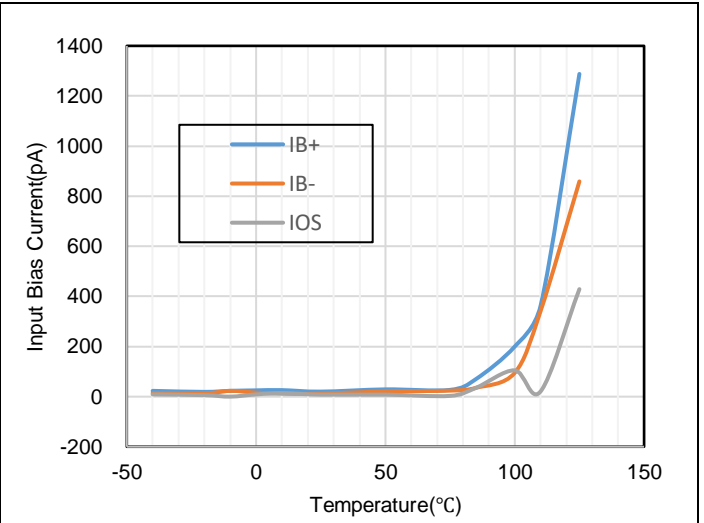

Figure 8. I_B vs. Temperature

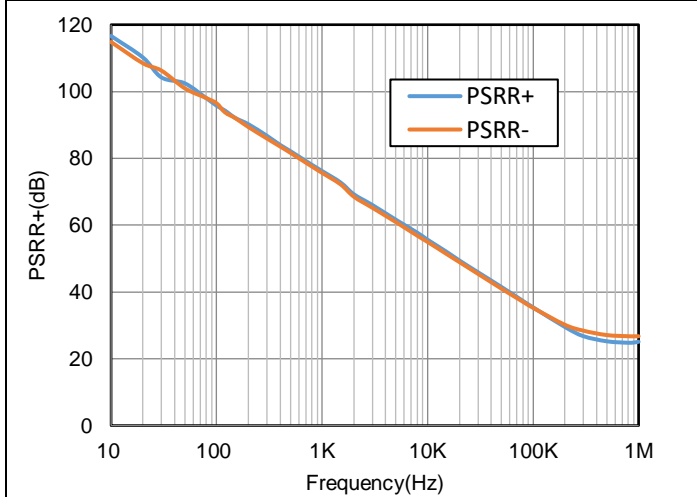

Figure 9. PSRR vs. Frequency

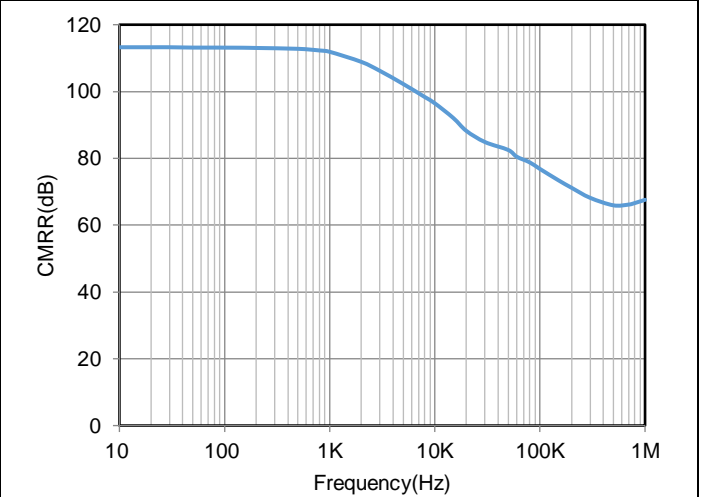

Figure 10. CMRR vs. Frequency

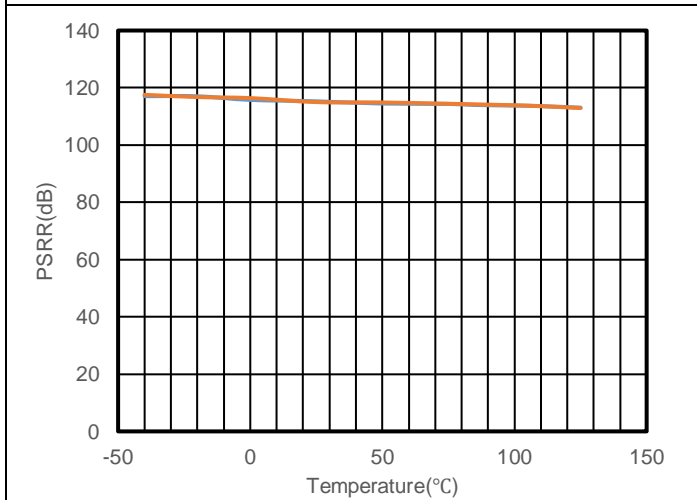

Figure 11. PSRR vs. Temperature

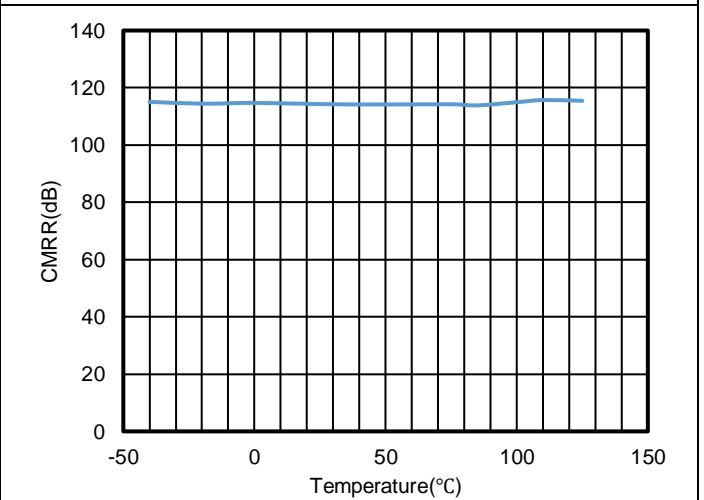

Figure 12. CMRR vs. Temperature

$V_S = \pm 15V$, $V_{CM} = 0V$, $R_L = 10k\Omega$, unless otherwise specified.

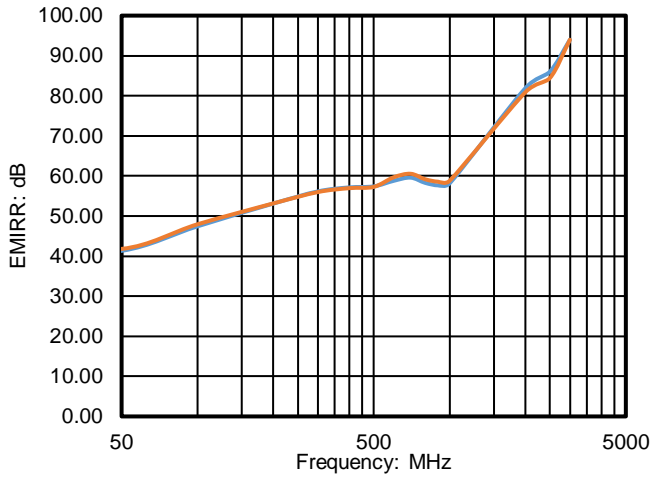

Figure 13. EMIRR+- vs. Frequency

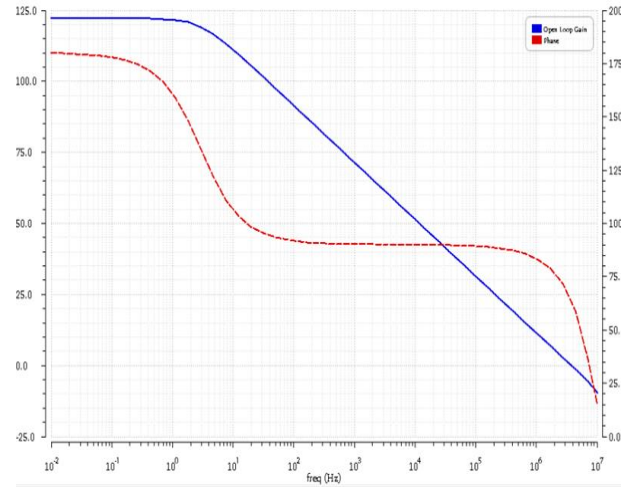

Figure 14. Open Loop Gain and Phase vs. Frequency

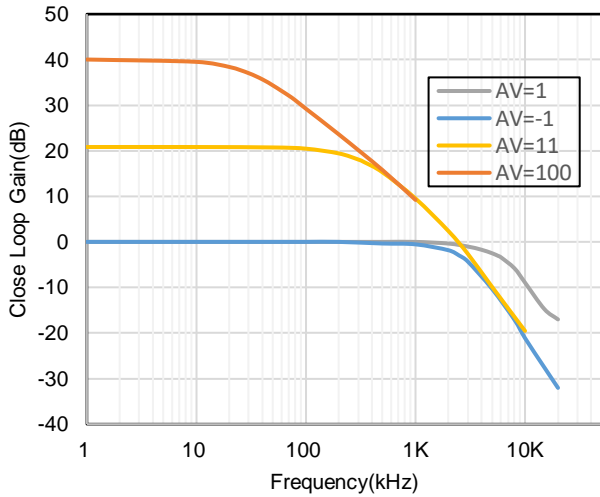
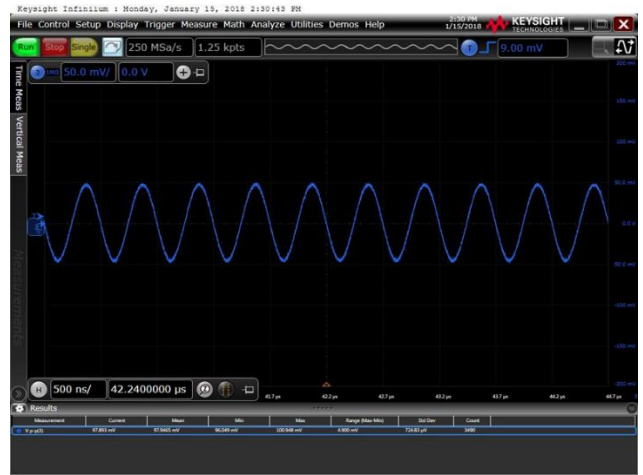

Figure 15. Close Loop Gain and Phase vs. Frequency



$V_S = \pm 1.5 V$, $V_{IN} = 100 mV_{PP}$, $R_L = 10 K$, $C_L = 100 pF$, $G = 1$

Figure 16. Waveform under 3V Supply Voltage

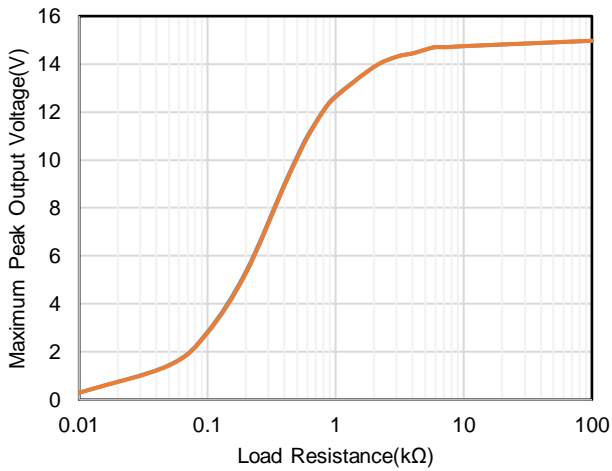

Figure 17. Maximum Peak Output Voltage vs. Load Resistance

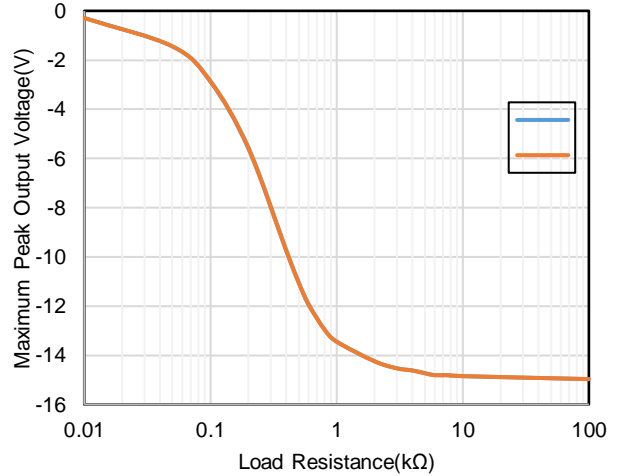

Figure 18. Maximum Peak Output Voltage vs. Load Resistance

$V_s = \pm 15V$, $V_{CM} = 0V$, $R_L = 10k\Omega$, unless otherwise specified.

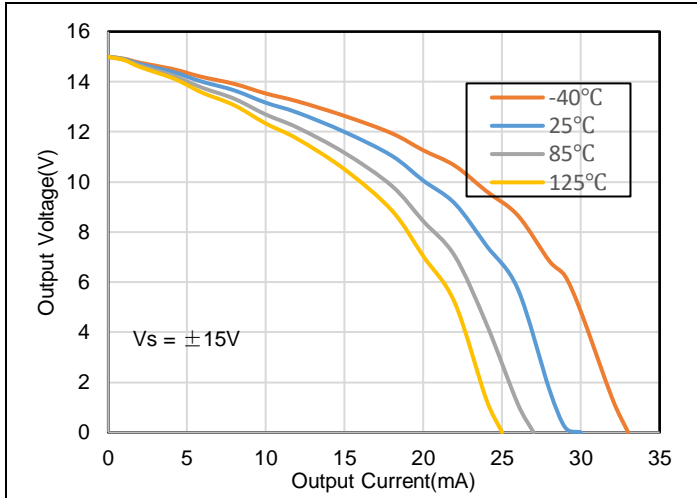

Figure 19. Positive Output Voltage vs. Output Current

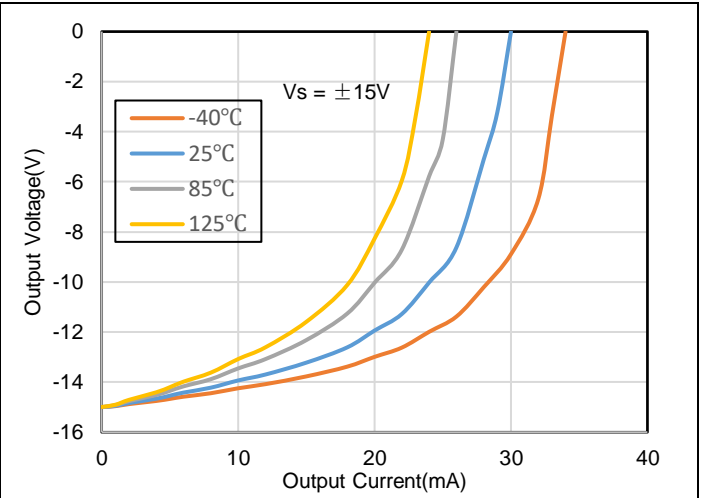

Figure 20. Negative Output Voltage vs. Output Current

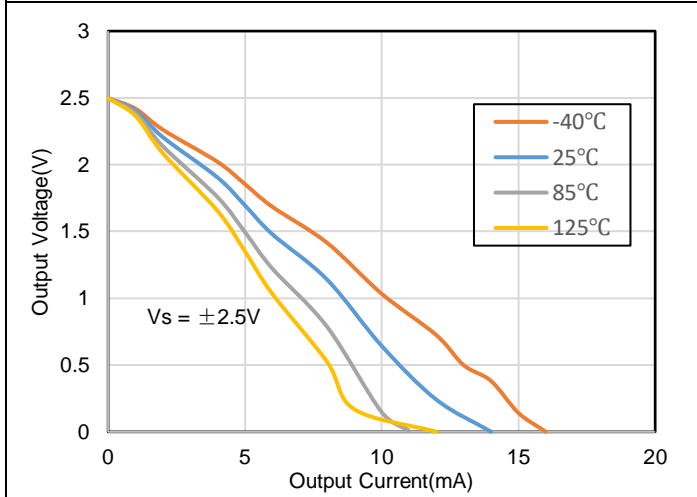

Figure 21. Positive Output Voltage vs. Output Current

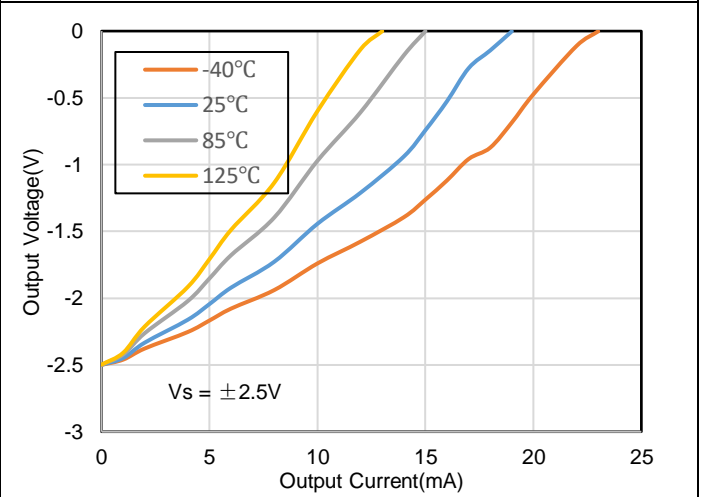

Figure 22. Negative Output Voltage vs. Output Current



Voltage: 1 V/div, Time: 200 ns/div
 $V_s = 5V$, $V_{IN} = 2V$, $R_L = \text{Open}$, $G = 3$
 Figure 23. Positive Overload Recovery



Voltage: 1 V/div, Time: 200 ns/div
 $V_s = 5V$, $V_{IN} = 2V$, $R_L = \text{Open}$, $G = 3$
 Figure 24. Negative Overload Recovery

$V_S = \pm 15V$, $V_{CM} = 0V$, $R_L = 10k\Omega$, unless otherwise specified.



Voltage: 20 mV/div, Time: 100 ns/div
 $V_S = \pm 15V$, $R_L = 2K$, $C_L = 100\text{ pF}$, $G=1$
 Figure 25. 100-mV Signal Step Response



Voltage: 2 V/div, Time: 1 μ s/div
 $V_S = \pm 15V$, $R_L = 2K$, $C_L = 100\text{ pF}$, $G=1$
 Figure 26. 10-V Signal Step Response

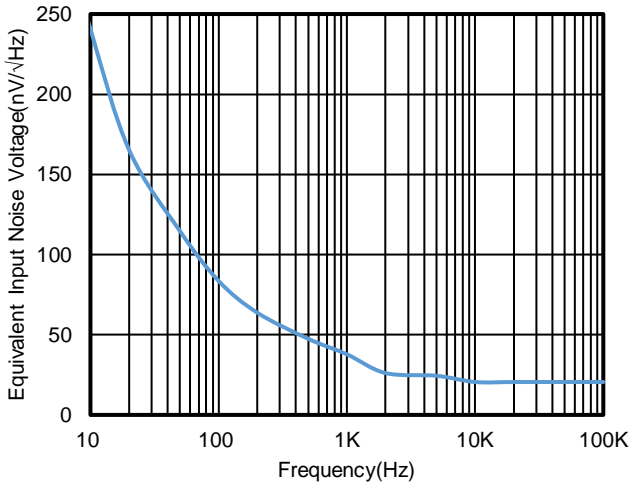

$V_S = \pm 15V$, $V_{CM} = 0V$

Figure 27. Voltage Noise Spectral Density vs. Frequency

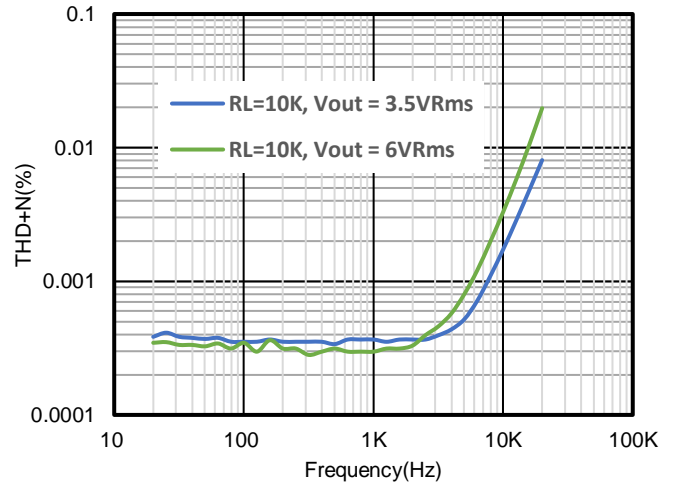

$V_S = \pm 15V$, $V_{CM} = 0V$, $G = 1$

Figure 28. THD+N vs. Frequency

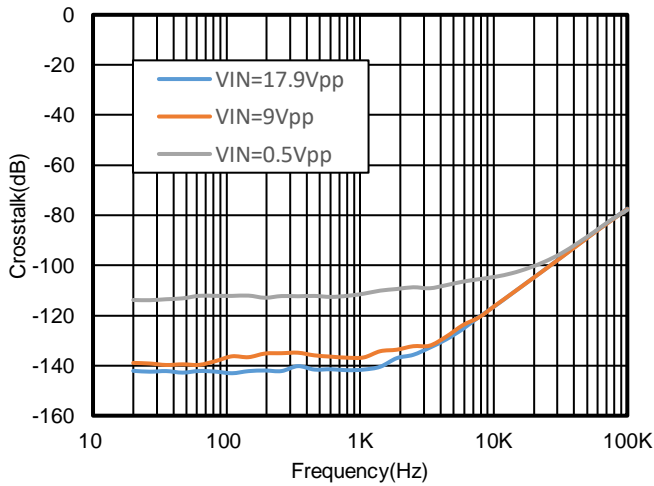

$V_S = \pm 15V$, $V_{CM} = 0V$

Figure 29. Crosstalk vs. Frequency

Tape and Reel Information

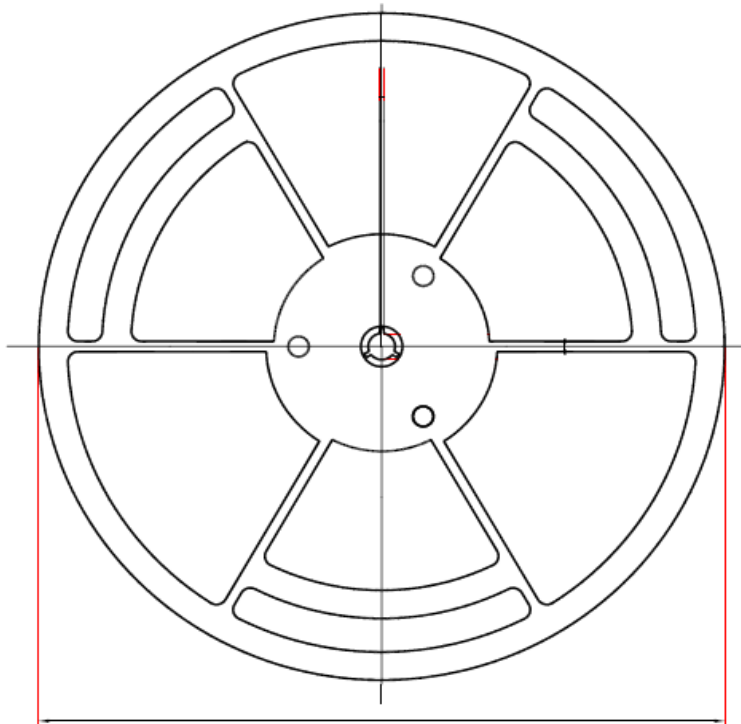

D1: Reel Diameter

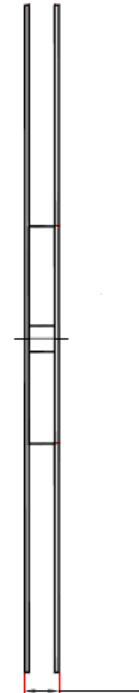

W1: Reel Width

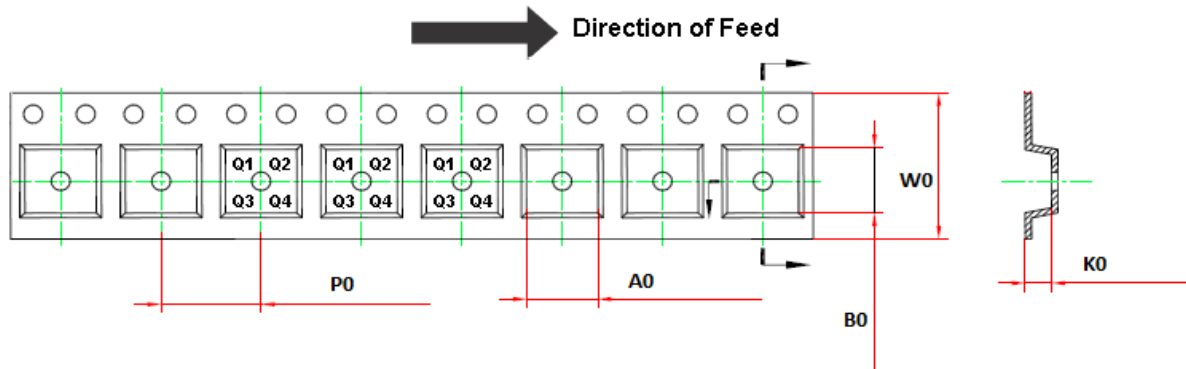

Order Number	Package	D1	W1	A0	B0	K0	P0	W0	Pin1 Quadrant
TP2261L1-S5TR-S	SOT23-5	179.0	12.0	3.3	3.25	1.4	4.0	8.0	Q3
TP2262L1-SO1R-S	SOP8	330.0	17.6	6.5	5.4	2.0	8.0	12.0	Q1
TP2264L1-SO2R-S	SOP14	330.0	21.6	6.5	9.1	1.8	8.0	16.0	Q1

Package Outline Dimensions

SOT23-5

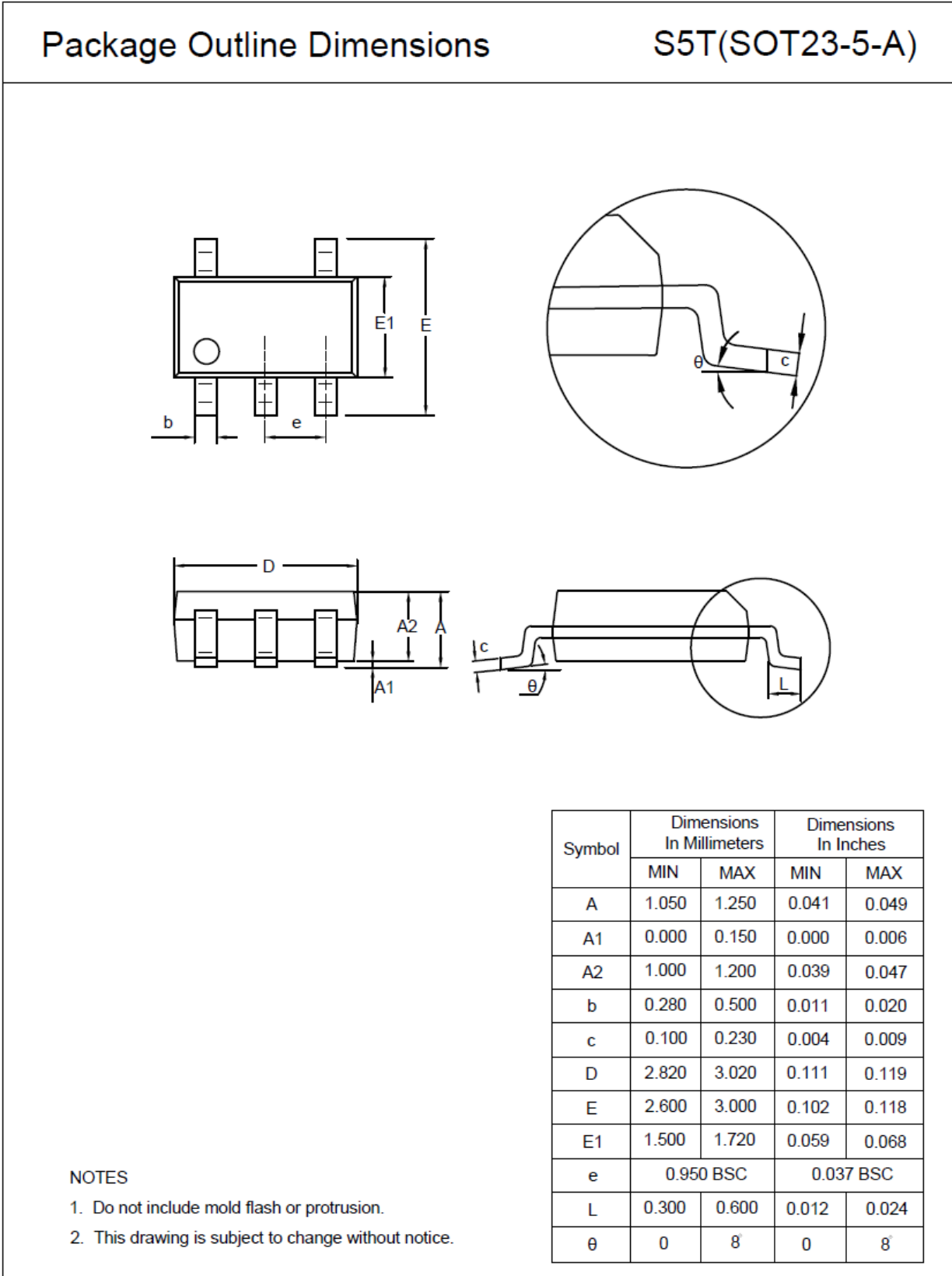

SOP8

Package Outline Dimensions

SO1(SOP-8-A)

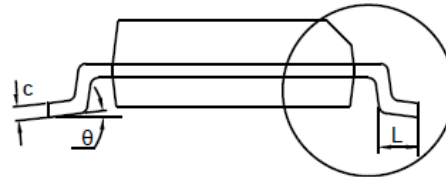
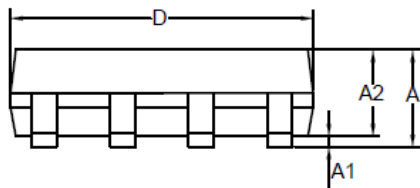
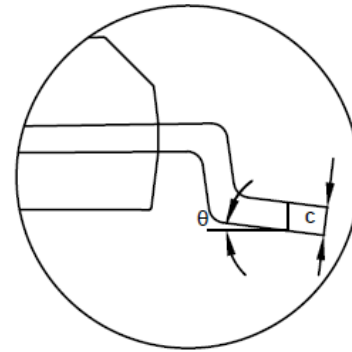
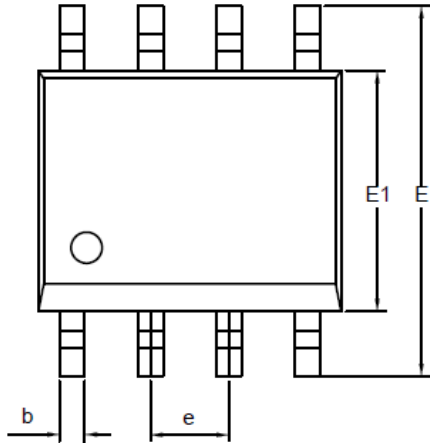

Symbol	Dimensions In Millimeters		Dimensions In Inches	
	MIN	MAX	MIN	MAX
A	1.350	1.750	0.053	0.069
A1	0.050	0.250	0.002	0.010
A2	1.250	1.550	0.049	0.061
b	0.330	0.510	0.013	0.020
c	0.170	0.250	0.007	0.010
D	4.700	5.100	0.185	0.201
E	5.800	6.200	0.228	0.244
E1	3.800	4.000	0.150	0.157
e	1.270 BSC		0.050 BSC	
L	0.400	1.000	0.016	0.039
θ	0	8°	0	8°

NOTES

1. Do not include mold flash or protrusion.
2. This drawing is subject to change without notice.

SOIC-14

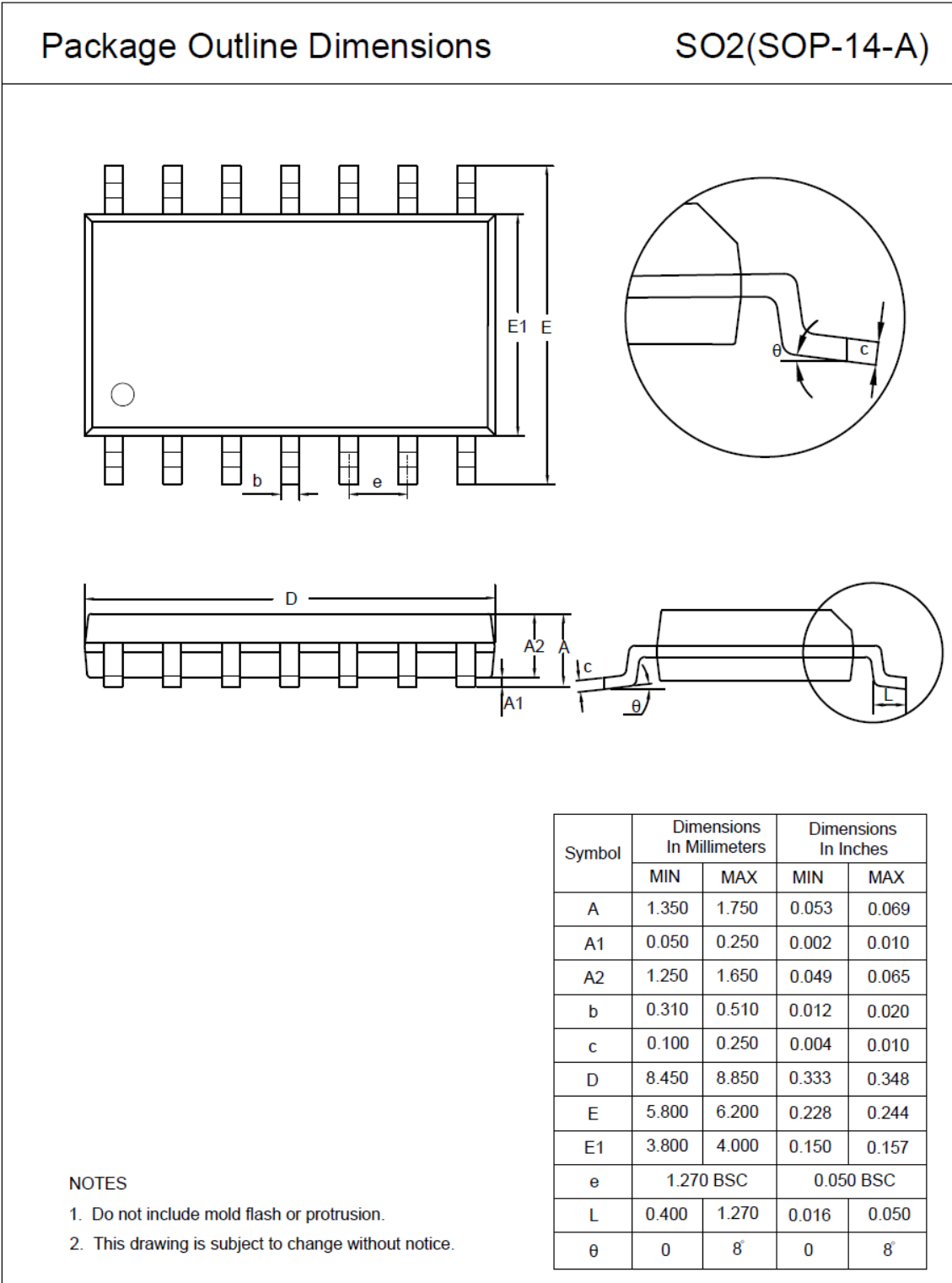

 ***3PEAK and the 3PEAK logo are registered trademarks of 3PEAK INCORPORATED. All other trademarks are the property of their respective owners.***
