

### Features

- Typical 1.4  $\mu$ A Ultra-low Quiescent Current
- Input Voltage Range: 2.4 V to 6 V
- Output Voltage Options:
  - Fixed: 1 V, 1.2 V, 1.8 V, 2.5 V, 2.8 V, 3 V, 3.3 V, 3.6 V
- $\pm 1\%$  Output Voltage Accuracy under Room Temperature
- Maximum Output Current: 400 mA
- Low Shutdown Current
- Low Dropout Voltage: 350 mV at 400 mA
- Current Limit and Thermal Protection
- Stable with 2.2  $\mu$ F Ceramic Capacitor
- Active Output Discharge While Disable
- Soft-start Limits Input Current Surge During Enable
- Junction Temperature Range:  $-40^{\circ}\text{C}$  to  $+125^{\circ}\text{C}$
- Packages: SOT23-3, SOT23-5, SOT89-3, 1 $\times$ 1 DFN-4

### Applications

- Handheld Devices with Battery Power Supply
- Portable Devices with Battery Power Supply
- Wearable Application, Bluetooth Headsets
- Wireless and IoT modules
- Personal Electronics, Personal Healthcare

### Description

The TPL720 series products are CMOS process low Iq linear regulators with enable control function. The TPL720 series products support a maximum 400mA output current, with typically only 1.4  $\mu$ A ultra-low quiescent current. TPL720 series products are stable with low-ESR small ceramic output capacitors from 2.2  $\mu$ F to 10  $\mu$ F.

The TPL720 series products have fast response performance when load current dynamic drops or raises, especially for the load-current dynamic from some load. The TPL720 series products have a current limit and thermal protection, which improves TPL720 series products with high reliability.

The TPL720 series products have a fixed output voltage range from 1 V to 3.6 V with  $\pm 1\%$  output voltage accuracy, line regulation, and load regulation under room temperature. The TPL720 series products are guaranteed over the junction temperature range of  $-40^{\circ}\text{C}$  to  $+125^{\circ}\text{C}$ . The TPL720 series products are available in a SOT23-3 package, SOT23-5 package, SOT89-3 package, and 1 $\times$ 1 DFN-4 package.

### Typical Application Circuit

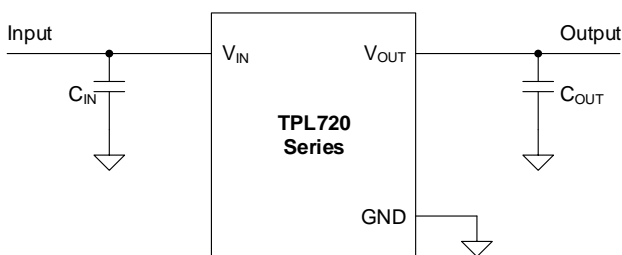

TPL720 Series without Enable Pin

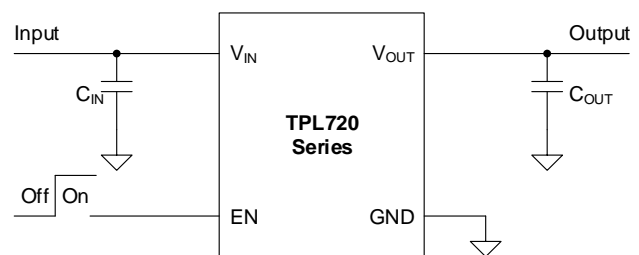

TPL720 Series with Enable Pin

**Product Family Table**

Order Number	Output Voltage	Package
TPL720F10-3TR	Fixed 1.0 V	SOT23-3
TPL720F12-3TR	Fixed 1.2 V	SOT23-3
TPL720F18-3TR	Fixed 1.8 V	SOT23-3
TPL720F25-3TR	Fixed 2.5 V	SOT23-3
TPL720F28-3TR	Fixed 2.8 V	SOT23-3
TPL720F30-3TR	Fixed 3.0 V	SOT23-3
TPL720F33-3TR	Fixed 3.3 V	SOT23-3
TPL720F36-3TR	Fixed 3.6 V	SOT23-3
TPL720F10-5TR	Fixed 1.0 V	SOT23-5
TPL720F12-5TR	Fixed 1.2 V	SOT23-5
TPL720F18-5TR	Fixed 1.8 V	SOT23-5
TPL720F25-5TR	Fixed 2.5 V	SOT23-5
TPL720F28-5TR	Fixed 2.8 V	SOT23-5
TPL720F30-5TR	Fixed 3.0 V	SOT23-5
TPL720F33-5TR	Fixed 3.3 V	SOT23-5
TPL720F36-5TR	Fixed 3.6 V	SOT23-5
TPL720F10-89TR	Fixed 1.0 V	SOT89-3
TPL720F12-89TR	Fixed 1.2 V	SOT89-3
TPL720F18-89TR	Fixed 1.8 V	SOT89-3
TPL720F25-89TR	Fixed 2.5 V	SOT89-3
TPL720F28-89TR	Fixed 2.8 V	SOT89-3
TPL720F30-89TR	Fixed 3.0 V	SOT89-3
TPL720F33-89TR	Fixed 3.3 V	SOT89-3
TPL720F36-89TR	Fixed 3.6 V	SOT89-3
TPL720F10-FR	Fixed 1.0 V	DFN1x1-4
TPL720F12-FR	Fixed 1.2 V	DFN1x1-4
TPL720F18-FR	Fixed 1.8 V	DFN1x1-4
TPL720F25-FR	Fixed 2.5 V	DFN1x1-4
TPL720F28-FR	Fixed 2.8 V	DFN1x1-4
TPL720F30-FR	Fixed 3.0 V	DFN1x1-4
TPL720F33-FR	Fixed 3.3 V	DFN1x1-4
TPL720F36-FR	Fixed 3.6 V	DFN1x1-4

## Table of Contents

<b>Features</b> .....	<b>1</b>
<b>Applications</b> .....	<b>1</b>
<b>Description</b> .....	<b>1</b>
<b>Typical Application Circuit</b> .....	<b>1</b>
<b>Product Family Table</b> .....	<b>2</b>
<b>Revision History</b> .....	<b>4</b>
<b>Pin Configuration and Functions</b> .....	<b>5</b>
Pin Functions.....	5
<b>Specifications</b> .....	<b>6</b>
Absolute Maximum Ratings.....	6
ESD, Electrostatic Discharge Protection .....	6
Recommended Operating Conditions .....	6
Thermal Information .....	6
Electrical Characteristics .....	7
Typical Performance Characteristics.....	8
<b>Detailed Description</b> .....	<b>10</b>
Overview.....	10
Functional Block Diagram .....	10
Feature Description .....	10
<b>Application and Implementation</b> .....	<b>12</b>
Application Information.....	12
Typical Application .....	12
<b>Layout</b> .....	<b>13</b>
Layout Guideline.....	13
<b>Tape and Reel Information</b> .....	<b>14</b>
<b>Package Outline Dimensions</b> .....	<b>15</b>
SOT23-3 .....	15
SOT23-5 .....	16
SOT89-3 .....	17
DFN1x1-4 .....	18
<b>Order Information</b> .....	<b>19</b>
<b>IMPORTANT NOTICE AND DISCLAIMER</b> .....	<b>21</b>

## Revision History

Date	Revision	Notes
2018-09-08	Rev.Pre	Preliminary Version
2019-01-10	Rev.A.0	Initial Release
2019-08-30	Rev.A.1	Add 3.6V Output Voltage Option
2021-03-29	Rev.A.2	1. Change the Pin 1 Orientation of the SOT23-3 package 2. Add Tape and Reel Information
2022-05-08	Rev.A.3	Replaced Operating Temperature Range with Junction Temperature Range

### Pin Configuration and Functions

3-Pin SOT23 Package

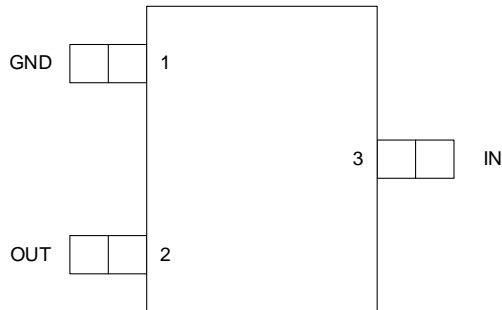

3-Pin SOT89 Package

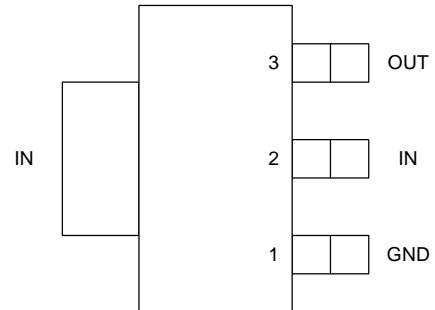

5-Pin SOT23 Package

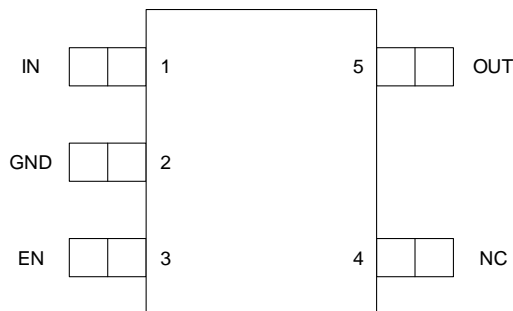

4-Pin DFN Package

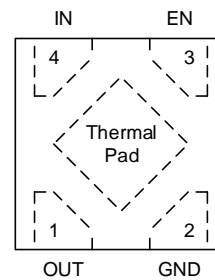

### Pin Functions

Name	Pin				I/O	Description
	SOT23 -3	SOT23 -5	SOT89 -3	DFN -4		
EN	-	3	-	3	I	Regulator enable pin. Drive EN high to turn on the regulator; drive EN low to turn off the regulator. For automatic startup, connect EN to IN directly.
GND	1	2	1	2	-	Ground reference pin. Connect GND pin to PCB ground plane directly.
IN	3	1	2	4	I	Input voltage pin. Bypass IN to GND with a 1 $\mu$ F or greater capacitor.
NC	-	4	-	-	-	No connection.
OUT	2	5	3	1	O	Regulated output voltage pin. Bypass OUT to GND with a 2.2 $\mu$ F or greater capacitor.

(1) Thermal pad must be connected to the PCB ground plane to maximize the thermal performance.

## Specifications

### Absolute Maximum Ratings

Parameter		Min	Max	Unit
$V_{IN}, V_{EN}$	Input Voltage	-0.3	6.5	V
$V_{OUT}$	Output Voltage	-0.3	6.5	V
$T_J$	Junction Temperature Range	-40	150	$^{\circ}$ C
$T_{STG}$	Storage Temperature Range	-65	150	$^{\circ}$ C
$T_L$	Lead Temperature (Soldering 10 sec)		260	$^{\circ}$ C

(1) Stresses beyond those listed under Absolute Maximum Ratings may cause permanent damage to the device. Exposure to any Absolute Maximum Rating condition for extended periods may affect device reliability and lifetime.

(2) All voltage values are with respect to GND.

### ESD, Electrostatic Discharge Protection

Symbol	Parameter	Condition	Minimum Level	Unit
HBM	Human Body Model ESD	ANSI/ESDA/JEDEC JS-001 <sup>(1)</sup>	$\pm 4$	V
CDM	Charged Device Model ESD	ANSI/ESDA/JEDEC JS-002 <sup>(2)</sup>	$\pm 1$	V

(1) JEDEC document JEP155 states that 500-V HBM allows safe manufacturing with a standard ESD control process.

(2) JEDEC document JEP157 states that 250-V CDM allows safe manufacturing with a standard ESD control process.

### Recommended Operating Conditions

Parameter		Min	Max	Unit
$V_{IN}$	Input Voltage	2.4	6	V
$V_{EN}$	Enable Voltage	0	$V_{IN}$	V
$V_{OUT}$	Output Voltage	0	5	V
$I_{OUT}$	Output Current	0	400	mA
$T_J$	Operating Junction Temperature Range	-40	125	$^{\circ}$ C

### Thermal Information

Package Type	$\theta_{JA}$	$\theta_{JC}$	Unit
SOT23-3	280	62	$^{\circ}$ C/W
SOT23-5	280	62	$^{\circ}$ C/W
SOT89-3	88	55	$^{\circ}$ C/W
1 $\times$ 1 DFN-4	210	110	$^{\circ}$ C/W

### Electrical Characteristics

All test conditions:  $V_{IN} = V_{OUT(NOM)} + 2\text{ V}$  or  $2.4\text{ V}$ , whichever is greater;  $C_{OUT} = 2.2\ \mu\text{F}$ ,  $T_A = +25^\circ\text{C}$ , unless otherwise noted.

Symbol	Parameter	Conditions	Min	Typ	Max	Unit
<b>Supply Voltage and Current</b>						
$V_{IN}$	Input voltage range		2.4		6	V
$I_{GND}$	Ground pin current	$I_{OUT} = 0\text{ mA}$		1.4		$\mu\text{A}$
		$I_{OUT} = 1\text{ mA}$		2.8		$\mu\text{A}$
$I_{SHDN}$	Shutdown current	EN = GND (4-/5-Pin Package Only)		0.1		$\mu\text{A}$
UVLO	$V_{IN}$ under-voltage lock-out	$V_{IN}$ rising		1.8		V
		Hysteresis		200		mV
<b>Enable Input Voltage and Current (4-/5-Pin Package Only)</b>						
$V_{IH(EN)}$	EN logic-input high level (enable)		1.2		$V_{IN}$	V
$V_{IL(EN)}$	EN logic-input low level (disable)		0		0.4	V
$I_{EN}$	EN pin leakage current	EN = $V_{IN}$		20		nA
<b>Regulated Output Voltage and Current</b>						
$V_{OUT}$	Output voltage accuracy	$I_{OUT} = 30\text{ mA}$ , $T_J = +25^\circ\text{C}$		1%		
		$I_{OUT} = 30\text{ mA}$ , $-40^\circ\text{C} \leq T_J \leq +125^\circ\text{C}$	-3%		3%	
$\Delta V_{OUT}$	Line regulation	$V_{IN} = V_{OUT(NOM)} + 2\text{ V}$ to $6\text{ V}$ , or $V_{IN} \geq 2.4\text{ V}$ , $I_{OUT} = 1\text{ mA}$		3		mV
	Load regulation	$I_{OUT} = 1\text{ mA}$ to $400\text{ mA}$		40		mV
$V_{DO}^{(1)}$	Dropout voltage	$V_{IN} = 0.98 \times V_{OUT(NOM)}$ , $I_{OUT} = 100\text{ mA}$		80		mV
		$V_{IN} = 0.98 \times V_{OUT(NOM)}$ , $I_{OUT} = 200\text{ mA}$		170		mV
		$V_{IN} = 0.98 \times V_{OUT(NOM)}$ , $I_{OUT} = 400\text{ mA}$		350		mV
$I_{OUT}$	Output current	$V_{OUT}$ in regulation	0		400	mA
$I_{CL}$	Output current limit	$V_{OUT} = 0.9 \times V_{OUT(NOM)}$	410	560	800	mA
$R_{DIS}$	Output discharge resistance	$V_{IN} = V_{OUT(NOM)} + 2\text{ V}$ , EN = GND		190		$\Omega$
PSRR	Power supply rejection ratio	$I_{OUT} = 10\text{ mA}$ , $f = 100\text{ Hz}$ , $C_{OUT} = 2.2\ \mu\text{F}$		55		dB
		$I_{OUT} = 10\text{ mA}$ , $f = 1\text{ kHz}$ , $C_{OUT} = 2.2\ \mu\text{F}$		54		dB
		$I_{OUT} = 10\text{ mA}$ , $f = 10\text{ kHz}$ , $C_{OUT} = 2.2\ \mu\text{F}$		50		dB
		$I_{OUT} = 10\text{ mA}$ , $f = 1\text{ MHz}$ , $C_{OUT} = 2.2\ \mu\text{F}$		53		dB
$V_N$	Output noise voltage	$I_{OUT} = 10\text{ mA}$ , BW = 10Hz to 100 kHz		90		$\mu\text{V}_{RMS}$
$t_{STR}$	Start-up time from EN assertion to $0.98 \times V_{OUT(NOM)}$	$I_{OUT} = 200\text{ mA}$ , $C_{OUT} = 2.2\ \mu\text{F}$		680		$\mu\text{s}$
<b>Temperature Range</b>						
$T_{SD}$	Thermal shutdown threshold			165		$^\circ\text{C}$
		Hysteresis		15		$^\circ\text{C}$

(1) Dropout voltage is the minimum input to output voltage differential needed to maintain regulation at a specified output current. In dropout, the output voltage will be equal to  $V_{IN} - V_{DROPOUT}$ .

### Typical Performance Characteristics

All test conditions:  $V_{IN} = V_{OUT(NOM)} + 2\text{ V}$  or  $2.4\text{ V}$ , whichever is greater,  $V_{OUT} = 3.3\text{ V}$ ,  $C_{OUT} = 2.2\text{ }\mu\text{F}$ ,  $T_A = +25^\circ\text{C}$ , unless otherwise noted.

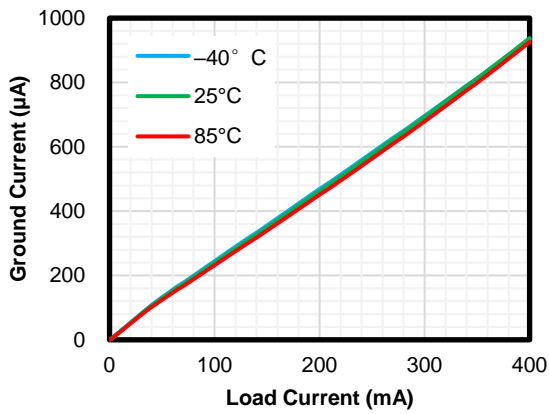

Figure 1 Ground Current vs Output Current

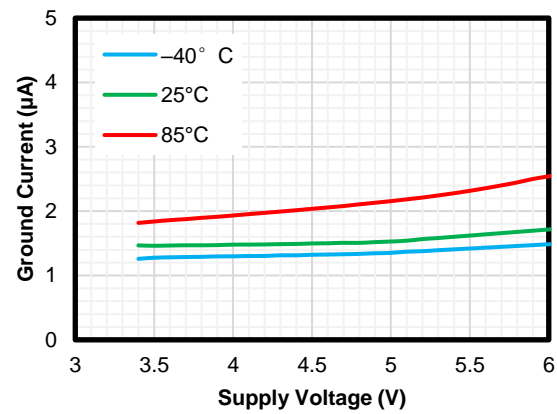
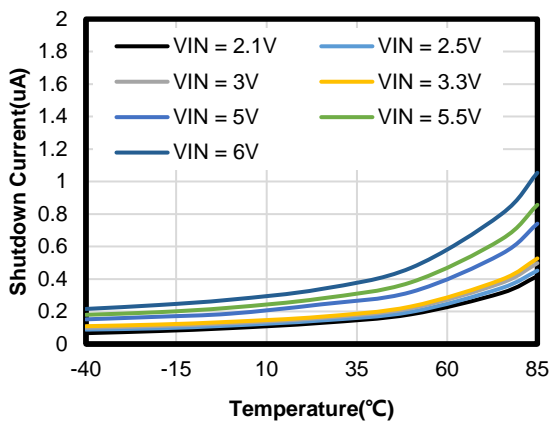

Figure 2 Quiescent Current vs Input Voltage



With Enable Pin

Figure 3 Shutdown Current vs Ambient Temperature

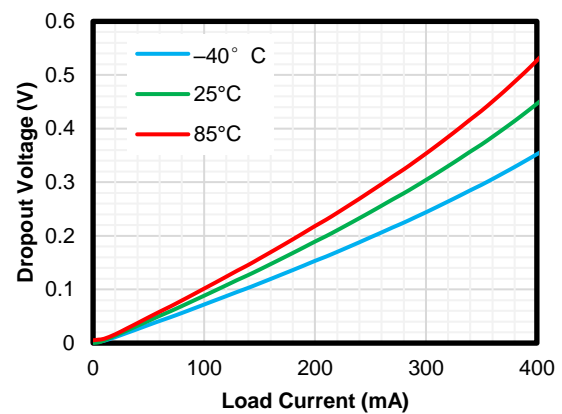

Figure 4 Dropout Voltage vs Output Current

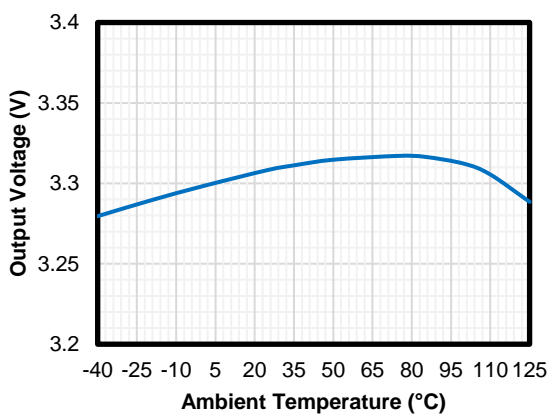

Figure 5 Output Accuracy vs Ambient Temperature

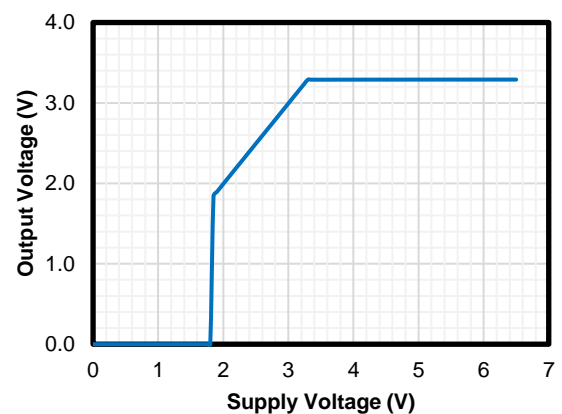

Figure 6 Output Voltage vs Input Voltage



### Typical Performance Characteristics (Continued)

All test conditions:  $V_{IN} = V_{OUT(NOM)} + 2\text{ V}$  or  $2.4\text{ V}$ , whichever is greater,  $V_{OUT} = 3.3\text{ V}$ ,  $C_{OUT} = 2.2\text{ }\mu\text{F}$ ,  $T_A = +25^\circ\text{C}$ , unless otherwise noted.

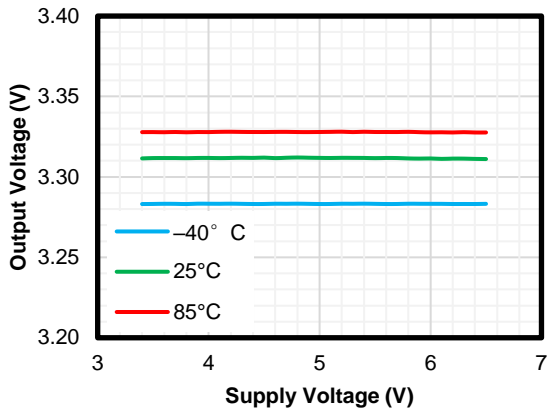

Figure 7. Line Regulation

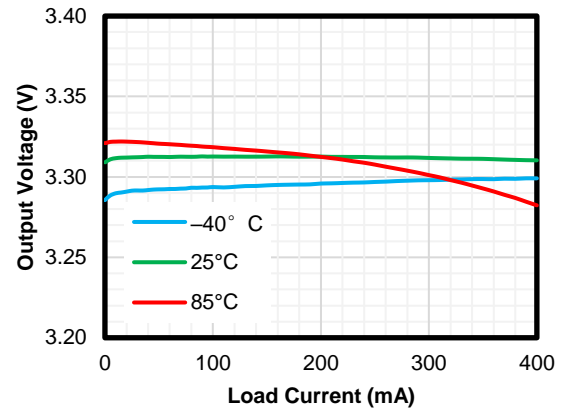

Figure 8. Load Regulation

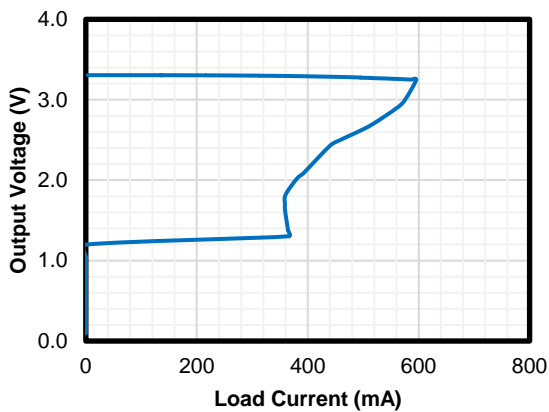
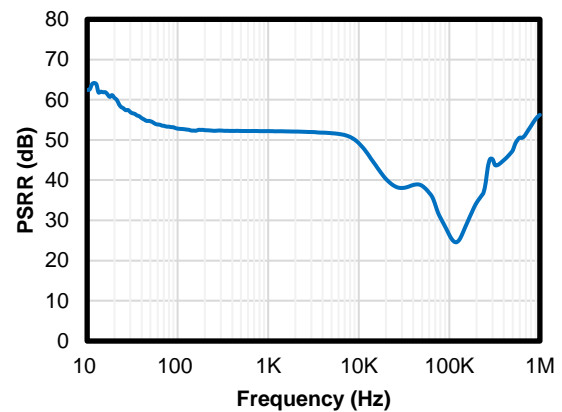

Figure 9. Current Limit



$I_{OUT} = 10\text{ mA}$        $C_{OUT} = 2.2\text{ }\mu\text{F}$

Figure 10. PSRR

### Detailed Description

#### Overview

The TPL720 series products are CMOS process low  $I_q$  linear regulators with ultra-low quiescent power consumption. The TPL720 series products support a maximum 400mA output current, with typically only 1.4  $\mu$ A quiescent current. TPL720 series products are stable with a low-ESR small ceramic output capacitor from 2.2 $\mu$ F to 10 $\mu$ F. The TPL720 series products are available in fixed voltage versions of 1V, 1.2 V, 1.8 V, 2.5 V, 2.8 V, 3 V, 3.3 V, and 3.6 V.

#### Functional Block Diagram

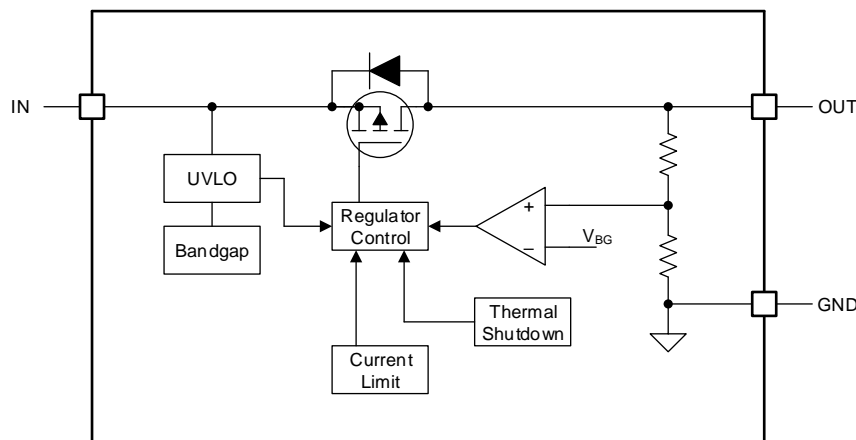

TPL720 Series without Enable Pin

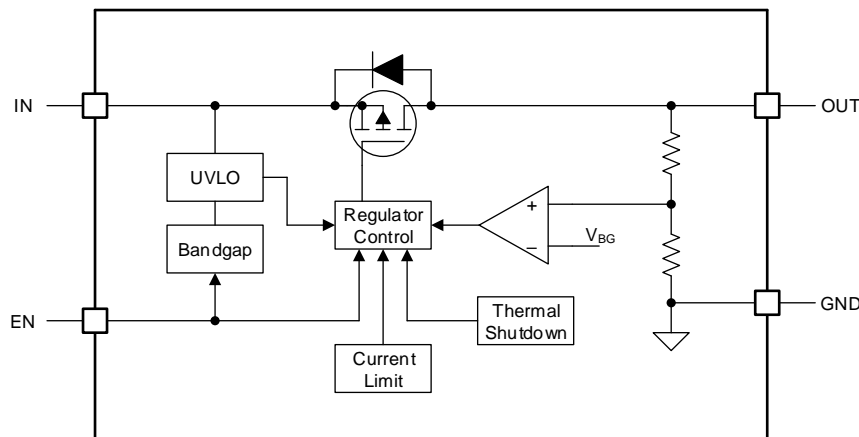

TPL720 Series with Enable Pin

#### Feature Description

##### Enable (4-/5-Pin Package Only)

The enable pin (EN) is active high. Connect this pin to the GPIO of an external processor or digital logic control circuit to enable and disable the device. Or connect this pin to the IN pin for self-bias applications.

**Under-voltage Lockout (UVLO)**

The TPL720 series use an under-voltage lockout circuit (UVLO = 1.8 V) to keep the output shut off until the internal circuitry operates properly.

**Regulated Output Voltage**

The TPL720 series are available in fixed voltage versions of 1V, 1.2 V, 1.8 V, 2.5 V, 2.8 V, 3 V, 3.3 V, and 3.6 V. When the input voltage is higher than  $V_{OUT(NOM)} + V_{DO}$  or 2.4V, the output pin is the regulated output based on the selected voltage version. When the input voltage falls below  $V_{OUT(NOM)} + V_{DO}$  or 2.4V, the output pin tracks the input voltage minus the dropout voltage based on the load current. When the input voltage drops below the UVLO threshold, the output keeps shutting off.

**Current Limit**

The TPL720 series integrate an internal current limit that helps to protect the regulator during fault conditions. When the output is overloaded or shorted to ground, the LDO supplies output current with limited value to prevent the regulator from being damaged. The output voltage is not regulated when the device is in current limit mode, and the value is  $V_{OUT} = I_{CL} \times R_{LOAD}$ .

**Thermal Shutdown**

During normal operation, LDO junction temperature should not exceed 125°C. When the junction temperature exceeds the thermal shutdown threshold, the LDO shut down the output immediately. Until when the junction temperature falls below the thermal shutdown threshold minus thermal shutdown hysteresis, the output turns on again.

## Application and Implementation

### NOTE

Information in the following applications sections is not part of the 3PEAK's component specification and 3PEAK does not warrant its accuracy or completeness. 3PEAK's customers are responsible for determining suitability of components for their purposes. Customers should validate and test their design implementation to confirm system functionality.

### Application Information

The TPL720 devices are a series of 400 mA high PSRR, low-dropout linear regulators with a low quiescent current. The following application schematic shows a typical usage of the TPL720 series.

### Typical Application

Figure 11 shows the typical application schematic of the TPL720 series.

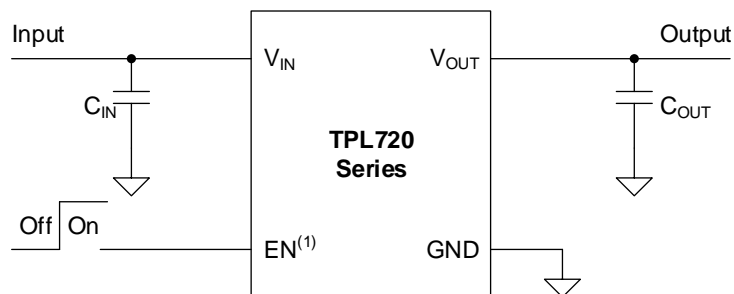

(1) EN pin is only available in a 4-/5-pin package

**Figure 11 TPL720 Series Application Schematic**

### Input Capacitor and Output Capacitor

3PEAK recommends adding a 1  $\mu$ F or greater capacitor with a 0.1  $\mu$ F bypass capacitor in parallel at IN pin to keep the input voltage stable. The voltage rating of the capacitors must be greater than the maximum input voltage.

To ensure loop stability, the TPL720 series requires an output capacitor with a minimum effective capacitance value of 2.2  $\mu$ F. 3PEAK recommends selecting an X5R- or X7R-type 4.7  $\mu$ F or larger ceramic capacitor with low ESR over temperature.

Both input capacitors and output capacitors must be placed as close to the device pins as possible.

### Power Dissipation

During normal operation, LDO junction temperature should not exceed 125°C. Using the below equations to calculate the power dissipation and estimate the junction temperature.

The power dissipation can be calculated using [Equation 1](#).

$$P_D = (V_{IN} - V_{OUT}) \times I_{OUT} + V_{IN} \times I_{GND} \quad (1)$$

The junction temperature can be estimated using [Equation 2](#).  $\theta_{JA}$  is the junction-to-ambient thermal resistance (See Section [Thermal Information](#)).

$$T_J = T_A + P_D \times \theta_{JA} \quad (2)$$

## Layout

### Layout Guideline

- Both input capacitors and output capacitors must be placed as close to the device pins as possible.
- It is recommended to bypass the input pin to the ground with a 0.1  $\mu$ F bypass capacitor. The loop area formed by the bypass capacitor connection, the IN pin, and the GND pin of the system must be as small as possible.
- It is recommended to use wide trace lengths or thick copper weight to minimize I $\times$ R drop and heat dissipation.

### Tape and Reel Information

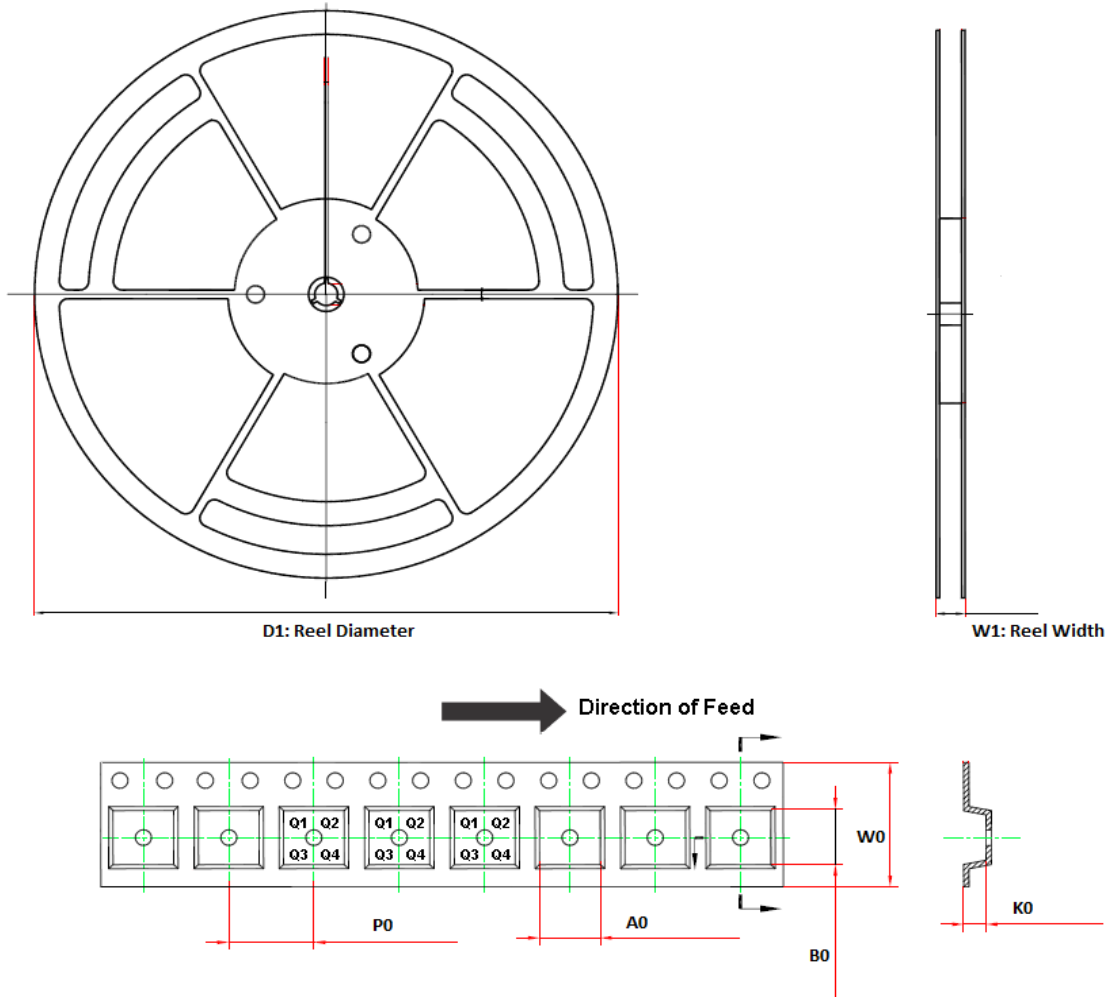

Order Number	Package	D1 (mm)	W1 (mm)	A0 (mm)	B0 (mm)	K0 (mm)	P0 (mm)	W0 (mm)	Pin1 Quadrant
TPL720Fxx-3TR	SOT23-3	180	13.1	3.18	3.28	1.32	4	8	Q3
TPL720Fxx-5TR	SOT23-5	180	13.1	3.2	3.2	1.4	4	8	Q3
TPL720Fxx-89TR	SOT89-3	330	17.6	4.8	4.4	1.8	8	12	Q3

(1) Output voltage value, xx = 10 to 36. e.g., 33 means 3.3 V output voltage.

Package Outline Dimensions

SOT23-3

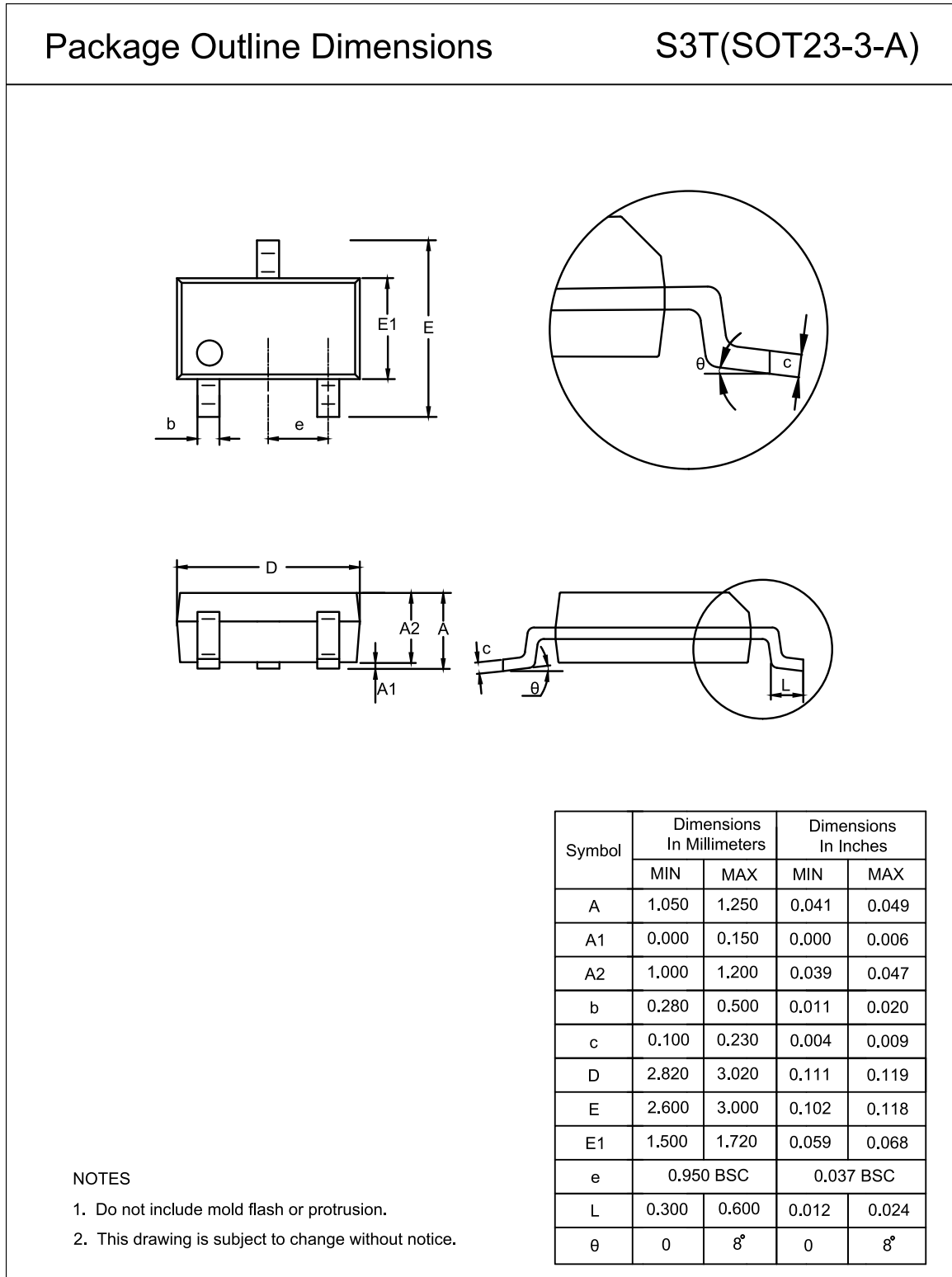

SOT23-5

Package Outline Dimensions

S5T(SOT23-5-A)

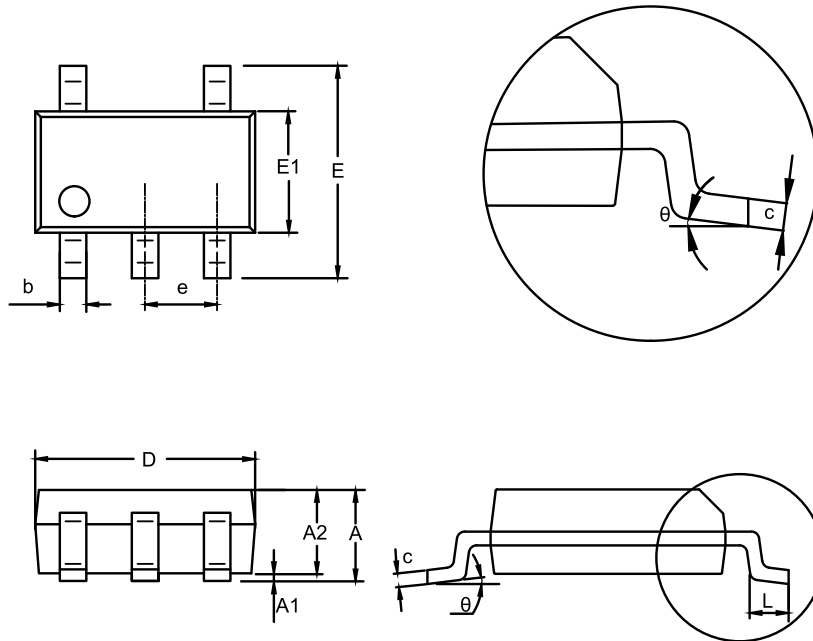

Symbol	Dimensions In Millimeters		Dimensions In Inches	
	MIN	MAX	MIN	MAX
A	1.050	1.250	0.041	0.049
A1	0.000	0.150	0.000	0.006
A2	1.000	1.200	0.039	0.047
b	0.280	0.500	0.011	0.020
c	0.100	0.230	0.004	0.009
D	2.820	3.020	0.111	0.119
E	2.600	3.000	0.102	0.118
E1	1.500	1.720	0.059	0.068
e	0.950 BSC		0.037 BSC	
L	0.300	0.600	0.012	0.024
θ	0	8°	0	8°

NOTES

1. Do not include mold flash or protrusion.
2. This drawing is subject to change without notice.



SOT89-3

Package Outline Dimensions

89T(SOT89-3-A)

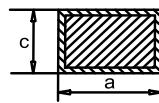
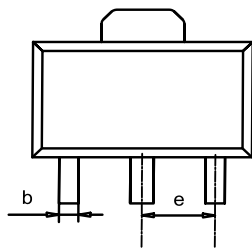

SECTION A-A

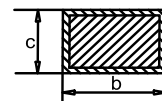

SECTION B-B

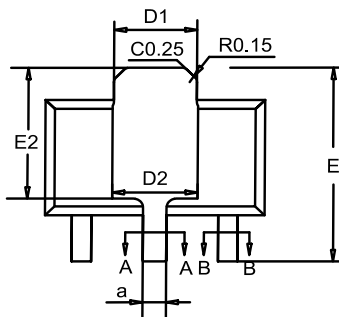
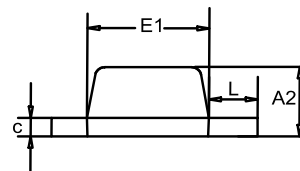
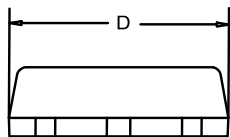

Symbol	Dimensions In Millimeters		Dimensions In Inches	
	MIN	MAX	MIN	MAX
A2	1.400	1.600	0.055	0.063
a	0.460	0.560	0.018	0.022
b	0.380	0.470	0.015	0.019
c	0.380	0.440	0.015	0.017
D	4.400	4.600	0.173	0.181
D1	1.600	1.830	0.063	0.072
E	3.950	4.250	0.156	0.167
E1	2.400	2.600	0.094	0.102
e	1.500 BSC		0.059 BSC	
D2	1.600	1.900	0.063	0.075
E2	2.700	3.100	0.106	0.122
L	0.890	1.200	0.035	0.047

NOTES

1. Do not include mold flash or protrusion.
2. This drawing is subject to change without notice.

DFN1x1-4

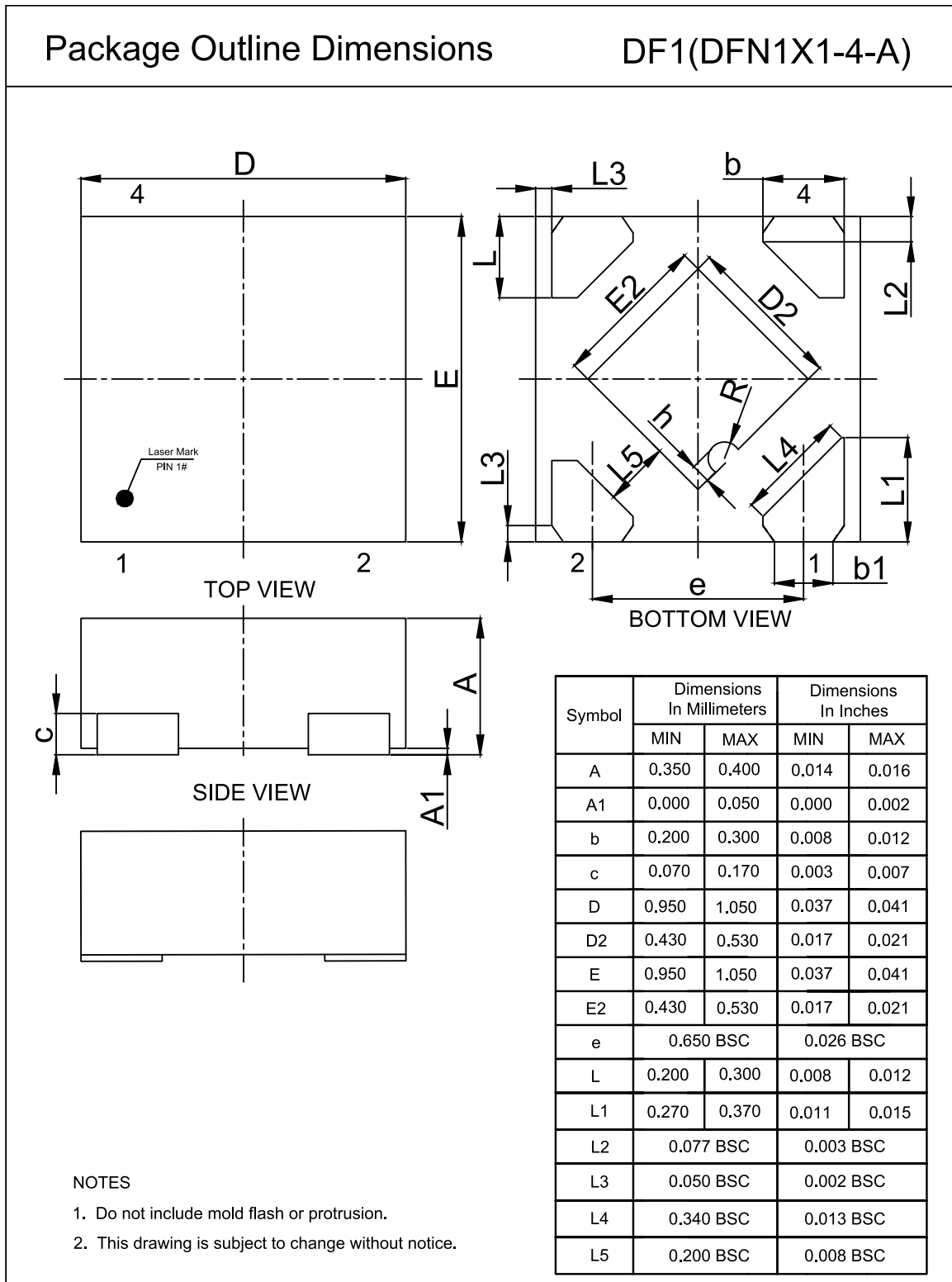

**Order Information**

Order Number	Junction Temperature Range	Package	Marking Information	MSL	Transport Media, Quantity	Eco Plan
TPL720F10-3TR <sup>(1)</sup>	-40 to 125°C	SOT23-3	L7C	MSL3	Tape and Reel, 3,000	Green
TPL720F12-3TR <sup>(1)</sup>	-40 to 125°C	SOT23-3	L7D	MSL3	Tape and Reel, 3,000	Green
TPL720F18-3TR	-40 to 125°C	SOT23-3	L7F	MSL3	Tape and Reel, 3,000	Green
TPL720F25-3TR <sup>(1)</sup>	-40 to 125°C	SOT23-3	L7G	MSL3	Tape and Reel, 3,000	Green
TPL720F28-3TR	-40 to 125°C	SOT23-3	L7H	MSL3	Tape and Reel, 3,000	Green
TPL720F30-3TR	-40 to 125°C	SOT23-3	L7I	MSL3	Tape and Reel, 3,000	Green
TPL720F33-3TR	-40 to 125°C	SOT23-3	L7J	MSL3	Tape and Reel, 3,000	Green
TPL720F36-3TR <sup>(1)</sup>	-40 to 125°C	SOT23-3	L7K	MSL3	Tape and Reel, 3,000	Green
TPL720F10-5TR <sup>(1)</sup>	-40 to 125°C	SOT23-5	L7C	MSL3	Tape and Reel, 3,000	Green
TPL720F12-5TR	-40 to 125°C	SOT23-5	L7D	MSL3	Tape and Reel, 3,000	Green
TPL720F18-5TR	-40 to 125°C	SOT23-5	L7F	MSL3	Tape and Reel, 3,000	Green
TPL720F25-5TR <sup>(1)</sup>	-40 to 125°C	SOT23-5	L7G	MSL3	Tape and Reel, 3,000	Green
TPL720F28-5TR	-40 to 125°C	SOT23-5	L7H	MSL3	Tape and Reel, 3,000	Green
TPL720F30-5TR	-40 to 125°C	SOT23-5	L7I	MSL3	Tape and Reel, 3,000	Green
TPL720F33-5TR	-40 to 125°C	SOT23-5	L7J	MSL3	Tape and Reel, 3,000	Green
TPL720F36-5TR <sup>(1)</sup>	-40 to 125°C	SOT23-5	L7K	MSL3	Tape and Reel, 3,000	Green

(1) Future product, contact 3PEAK factory for more information and sample.

(2) Green: 3PEAK defines "Green" to mean RoHS compatible and free of halogen substances.

**400 mA output, 1  $\mu$ A Ultra-Low Quiescent Current LDO**

Order Number	Junction Temperature Range	Package	Marking Information	MSL	Transport Media, Quantity	Eco Plan
TPL720F10-89TR <sup>(1)</sup>	-40 to 125°C	SOT89-3	L7C	MSL3	Tape and Reel, 4,000	Green
TPL720F12-89TR <sup>(1)</sup>	-40 to 125°C	SOT89-3	L7D	MSL3	Tape and Reel, 4,000	Green
TPL720F18-89TR <sup>(1)</sup>	-40 to 125°C	SOT89-3	L7F	MSL3	Tape and Reel, 4,000	Green
TPL720F25-89TR <sup>(1)</sup>	-40 to 125°C	SOT89-3	L7G	MSL3	Tape and Reel, 4,000	Green
TPL720F28-89TR	-40 to 125°C	SOT89-3	L7H	MSL3	Tape and Reel, 4,000	Green
TPL720F30-89TR	-40 to 125°C	SOT89-3	L7I	MSL3	Tape and Reel, 4,000	Green
TPL720F33-89TR	-40 to 125°C	SOT89-3	L7J	MSL3	Tape and Reel, 4,000	Green
TPL720F36-89TR <sup>(1)</sup>	-40 to 125°C	SOT89-3	L7K	MSL3	Tape and Reel, 4,000	Green
TPL720F10-FR <sup>(1)</sup>	-40 to 125°C	DFN1x1-4	L7C	MSL3	Tape and Reel, 12,000	Green
TPL720F12-FR <sup>(1)</sup>	-40 to 125°C	DFN1x1-4	L7D	MSL3	Tape and Reel, 12,000	Green
TPL720F18-FR <sup>(1)</sup>	-40 to 125°C	DFN1x1-4	L7F	MSL3	Tape and Reel, 12,000	Green
TPL720F25-FR <sup>(1)</sup>	-40 to 125°C	DFN1x1-4	L7G	MSL3	Tape and Reel, 12,000	Green
TPL720F28-FR <sup>(1)</sup>	-40 to 125°C	DFN1x1-4	L7H	MSL3	Tape and Reel, 12,000	Green
TPL720F30-FR <sup>(1)</sup>	-40 to 125°C	DFN1x1-4	L7I	MSL3	Tape and Reel, 12,000	Green
TPL720F33-FR <sup>(1)</sup>	-40 to 125°C	DFN1x1-4	L7J	MSL3	Tape and Reel, 12,000	Green
TPL720F36-FR <sup>(1)</sup>	-40 to 125°C	DFN1x1-4	L7K	MSL3	Tape and Reel, 12,000	Green

(1) Future product, contact 3PEAK factory for more information and sample.

(2) Green: 3PEAK defines "Green" to mean RoHS compatible and free of halogen substances.

## IMPORTANT NOTICE AND DISCLAIMER

**Copyright**© 3PEAK 2012-2023. All rights reserved.

**Trademarks.** Any of the 思瑞浦 or 3PEAK trade names, trademarks, graphic marks, and domain names contained in this document /material are the property of 3PEAK. You may NOT reproduce, modify, publish, transmit or distribute any Trademark without the prior written consent of 3PEAK.

**Performance Information.** Performance tests or performance range contained in this document/material are either results of design simulation or actual tests conducted under designated testing environment. Any variation in testing environment or simulation environment, including but not limited to testing method, testing process or testing temperature, may affect actual performance of the product.

**Disclaimer.** 3PEAK provides technical and reliability data (including data sheets), design resources (including reference designs), application or other design recommendations, networking tools, security information and other resources "As Is". 3PEAK makes no warranty as to the absence of defects, and makes no warranties of any kind, express or implied, including without limitation, implied warranties as to merchantability, fitness for a particular purpose or non-infringement of any third-party's intellectual property rights. Unless otherwise specified in writing, products supplied by 3PEAK are not designed to be used in any life-threatening scenarios, including critical medical applications, automotive safety-critical systems, aviation, aerospace, or any situations where failure could result in bodily harm, loss of life, or significant property damage. 3PEAK disclaims all liability for any such unauthorized use.