

Xtreme Varistor Series

Radial Leaded Varistors

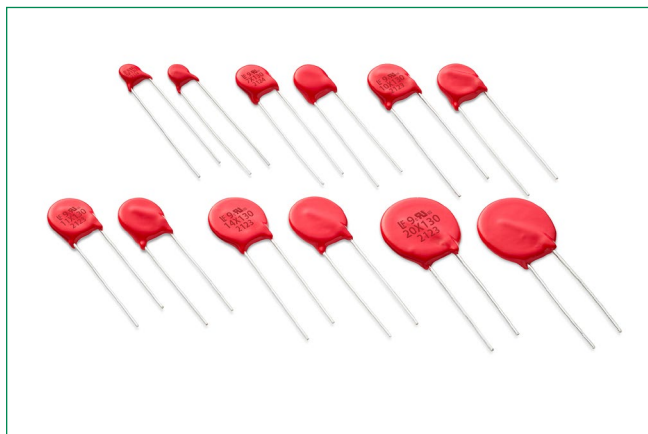

Description

Littelfuse Xtreme Varistor Series is specifically designed for applications requiring high surge energy/current absorption and multiple surge pulse withstanding capability. Xtreme Varistor Series is available in six nominal disc sizes: 5 mm, 7 mm, 10 mm, 11 mm, 14 mm, and 20 mm.

Features and Benefits

- High operating temperature: 125 °C
- High surge energy/current absorption withstanding capability
- Passed Needle Flame Test per IEC 61051-1
- RoHS compliant, Halogen-free, and Pb-free
- More reliable and suitable for high operating temperature products
- Extend product reliability and lifespan
- Suitable for operational environments requiring UL94V-0 flammability rating
- Environment-friendly

Web Resources



Download ECAD models, order samples, and find technical resources at www.littelfuse.com

Agency Approvals

Agency	Standards	Agency File Number
	UL 1449 CSA C22.2 No. 269-5	E320116 ¹
	IEC 61051-1 IEC 61051-2 IEC 61051-2-2 Annex Q of IEC 60950-1 Annex G of IEC 62368-1	J50519458 ²
	GB/T 10193 GB/T 10194 GB 4943.1 GB 8898	CQC21001319340 for V10X** parts ² CQC21001319369 for V11X** parts ² CQC21001319760 for V14X** parts ²

Notes:

- 1. All epoxy coated sizes are UL recognized while only 14mm phenolic coated parts are UL recognized
- 2. Epoxy coated only

Applications

- Home appliance
- Outdoor LED lighting driver/power supply
- Switch Mode Power Supply (SMPS)
- Surge Protection Device (SPD) Type 2, Type 3, and Type 4CA
- Ground Fault Circuit Interrupter (GFCI and AFCI)
- Smart E-meter
- Home automation and security systems: fire alarm, smoke detector

Absolute Maximum Ratings

Electrical Characteristics	Xtreme Varistor Series	Units
Maximum Continuous Operating Voltage (MCOV): AC Voltage Range ($V_{M(AC)(RMS)}$)	130 to 680	V
Maximum Continuous Operating Voltage (MCOV): DC Voltage Range ($V_{M(DC)}$)	170 to 895	V
Transients		
Pulse Current (I_{TM}) 8x20 μ s Wave		
Maximum Peak Current (8/20 μ s 1xPulse)	1200 to 15000	A
Rated Energy (2 ms or 10/1000 μ s 1x Pulse)	9.5 to 880	J
Operating Ambient Temperature Range (T_A)	-40 to +125	°C
Storage Temperature Range (T_{STG})	-40 to +150	°C
Temperature Coefficient (aV) of Clamping Voltage (V) at Specified Test Current	<0.01	%/°C
Hi-Pot Encapsulation (COATING Isolation Voltage Capability) for Epoxy coated	2500	V
Hi-Pot Encapsulation (COATING Isolation Voltage Capability) for Phenolic coated	800	V
COATING Insulation Resistance	1000	M Ω

Caution:

- Stresses above those listed in "Absolute Maximum Ratings" may cause permanent damage to the device. This is a stress only rating and operation of the device at these or any other conditions above those indicated in the operational sections of this specification is not implied.
- For ratings of individual members of a series, see Device Ratings and Specifications chart.

Xtreme Varistor Series

Radial Leaded Varistors

Electrical Specifications

Part Number	Maximum Continuous Operating Voltage (MCOV)		Rated Energy (2 ms or 10/1000 μ s, 1x Pulse)	Maximum Peak Current (8/20 μ s, 1x Pulse)	Nominal Discharge Current (8/20 μ s, 15 Pulses)	Rated Average Dissipation Power	Combination Pulse (Voltage 1.2/50 μ s, Current 8/20 μ s 10 Pulses)
	V _{RMS} (V)	V _{DC} (V)	W _{max} (J)	I _{max} (A)	I _n (A)	P _{max} (W)	
V05X130E	130	170	9.5	1200	500	0.25	1KV / 0.5KA
V05X140E	140	180	10	1200	500	0.25	1KV / 0.5KA
V05X150E	150	200	11	1200	500	0.25	1KV / 0.5KA
V05X175E	175	225	13	1200	500	0.25	1KV / 0.5KA
V05X195E	195	250	14	1200	500	0.25	1KV / 0.5KA
V05X210E	210	270	15	1200	500	0.25	1KV / 0.5KA
V05X230E	230	300	17	1200	500	0.25	1KV / 0.5KA
V05X250E	250	320	19	1200	500	0.25	1KV / 0.5KA
V05X275E	275	350	21	1200	500	0.25	1KV / 0.5KA
V05X300E	300	385	23	1200	500	0.25	1KV / 0.5KA
V07X130E	130	170	19	2500	1200	0.3	2.4KV / 1.2KA
V07X140E	140	180	22	2500	1200	0.3	2.4KV / 1.2KA
V07X150E	150	200	24	2500	1200	0.3	2.4KV / 1.2KA
V07X175E	175	225	28	2500	1200	0.3	2.4KV / 1.2KA
V07X195E	195	250	30	2500	1200	0.3	2.4KV / 1.2KA
V07X210E	210	270	32	2500	1200	0.3	2.4KV / 1.2KA
V07X230E	230	300	36	2500	1200	0.3	2.4KV / 1.2KA
V07X250E	250	320	38	2500	1200	0.3	2.4KV / 1.2KA
V07X275E	275	350	43	2500	1200	0.3	2.4KV / 1.2KA
V07X300E	300	385	47	2500	1200	0.3	2.4KV / 1.2KA
V07X320E	320	410	50	2500	1200	0.3	2.4KV / 1.2KA
V07X330E	330	435	52	2500	1200	0.3	2.4KV / 1.2KA
V07X350E	350	450	55	2500	1200	0.3	2.4KV / 1.2KA
V07X385E	385	505	60	2500	1200	0.3	2.4KV / 1.2KA
V07X420E	420	560	65	2500	1200	0.3	2.4KV / 1.2KA
V07X440E	440	585	68	2500	1200	0.3	2.4KV / 1.2KA
V10X130E	130	170	34	4500	3000	0.5	6KV / 3KA
V10X140E	140	180	36	4500	3000	0.5	6KV / 3KA
V10X150E	150	200	40	4500	3000	0.5	6KV / 3KA
V10X175E	175	225	46	4500	3000	0.5	6KV / 3KA
V10X195E	195	250	49	4500	3000	0.5	6KV / 3KA
V10X210E	210	270	52	4500	3000	0.5	6KV / 3KA
V10X230E	230	300	60	4500	3000	0.5	6KV / 3KA
V10X250E	250	320	65	4500	3000	0.5	6KV / 3KA
V10X275E	275	350	71	4500	3000	0.5	6KV / 3KA
V10X300E	300	385	76	4500	3000	0.5	6KV / 3KA
V10X320E	320	410	84	4500	3000	0.5	6KV / 3KA
V10X330E	330	435	84	4500	3000	0.5	6KV / 3KA
V10X350E	350	450	86	4500	3000	0.5	6KV / 3KA
V10X385E	385	505	88	4500	3000	0.5	6KV / 3KA

Xtreme Varistor Series

Radial Ledged Varistors

Electrical Specifications

Part Number	Maximum Continuous Operating Voltage (MCOV)		Rated Energy (2 ms or 10/1000 μ s, 1x Pulse)	Maximum Peak Current (8/20 μ s, 1x Pulse)	Nominal Discharge Current (8/20 μ s, 15 Pulses)	Rated Average Dissipation Power	Combination Pulse (Voltage 1.2/50 μ s, Current 8/20 μ s 10 Pulses)
	V _{RMS} (V)	V _{DC} (V)	W _{max} (J)	I _{max} (A)	I _n (A)	P _{max} (W)	
V10X420E	420	560	95	4500	3000	0.5	6KV / 3KA
V10X440E	440	585	98	4500	3000	0.5	6KV / 3KA
V10X460E	460	615	100	4500	3000	0.5	6KV / 3KA
V10X510E	510	670	110	4500	3000	0.5	6KV / 3KA
V10X550E	550	745	112	4500	3000	0.5	6KV / 3KA
V10X625E	625	825	130	4500	3000	0.5	6KV / 3KA
V10X680E	680	895	140	4500	3000	0.5	6KV / 3KA
V11X130E	130	170	57	6000	4000	0.6	8KV / 4KA
V11X140E	140	180	60	6000	4000	0.6	8KV / 4KA
V11X150E	150	200	60	6000	4000	0.6	8KV / 4KA
V11X175E	175	225	70	6000	4000	0.6	8KV / 4KA
V11X195E	195	250	75	6000	4000	0.6	8KV / 4KA
V11X210E	210	270	80	6000	4000	0.6	8KV / 4KA
V11X230E	230	300	90	6000	4000	0.6	8KV / 4KA
V11X250E	250	320	100	6000	4000	0.6	8KV / 4KA
V11X275E	275	350	115	6000	4000	0.6	8KV / 4KA
V11X300E	300	385	125	6000	4000	0.6	8KV / 4KA
V11X320E	320	410	136	6000	4000	0.6	8KV / 4KA
V11X330E	330	435	136	6000	4000	0.6	8KV / 4KA
V11X350E	350	450	136	6000	4000	0.6	8KV / 4KA
V11X385E	385	505	136	6000	4000	0.6	8KV / 4KA
V11X420E	420	560	136	6000	4000	0.6	8KV / 4KA
V11X440E	440	585	150	6000	4000	0.6	8KV / 4KA
V11X460E	460	615	150	6000	4000	0.6	8KV / 4KA
V11X510E	510	670	165	6000	4000	0.6	8KV / 4KA
V11X550E	550	745	180	6000	4000	0.6	8KV / 4KA
V11X625E	625	825	200	6000	4000	0.6	8KV / 4KA
V11X680E	680	895	220	6000	4000	0.6	8KV / 4KA
V14X130E	130	170	100	10000	5000	1.0	10KV / 5KA
V14X140E	140	180	110	10000	5000	1.0	10KV / 5KA
V14X150E	150	200	120	10000	5000	1.0	10KV / 5KA
V14X175E	175	225	135	10000	5000	1.0	10KV / 5KA
V14X195E	195	250	150	10000	5000	1.0	10KV / 5KA
V14X210E	210	270	160	10000	5000	1.0	10KV / 5KA
V14X230E	230	300	180	10000	5000	1.0	10KV / 5KA
V14X250E	250	320	195	10000	5000	1.0	10KV / 5KA
V14X275E	275	350	215	10000	5000	1.0	10KV / 5KA
V14X300E	300	385	250	10000	5000	1.0	10KV / 5KA
V14X320E	320	410	273	10000	5000	1.0	10KV / 5KA
V14X330E	330	435	273	10000	5000	1.0	10KV / 5KA

Xtreme Varistor Series

Radial Leded Varistors

Electrical Specifications

Part Number	Maximum Continuous Operating Voltage (MCOV)		Rated Energy (2 ms or 10/1000 μ s, 1x Pulse)	Maximum Peak Current (8/20 μ s, 1x Pulse)	Nominal Discharge Current (8/20 μ s, 15 Pulses)	Rated Average Dissipation Power	Combination Pulse (Voltage 1.2/50 μ s, Current 8/20 μ s 10 Pulses)
	V _{RMS} (V)	V _{DC} (V)	W _{max} (J)	I _{max} (A)	I _n (A)	P _{max} (W)	
V14X350E	350	450	273	10000	5000	1.0	10KV / 5KA
V14X385E	385	505	273	10000	5000	1.0	10KV / 5KA
V14X420E	420	560	273	10000	5000	1.0	10KV / 5KA
V14X440E	440	585	280	10000	5000	1.0	10KV / 5KA
V14X460E	460	615	300	10000	5000	1.0	10KV / 5KA
V14X510E	510	670	325	10000	5000	1.0	10KV / 5KA
V14X550E	550	745	360	10000	5000	1.0	10KV / 5KA
V14X625E	625	825	400	10000	5000	1.0	10KV / 5KA
V14X680E	680	895	440	10000	5000	1.0	10KV / 5KA
V20X130E	130	170	200	15000	8000	1.2	16KV / 8KA
V20X140E	140	180	220	15000	8000	1.2	16KV / 8KA
V20X150E	150	200	240	15000	8000	1.2	16KV / 8KA
V20X175E	175	225	270	15000	8000	1.2	16KV / 8KA
V20X195E	195	250	300	15000	8000	1.2	16KV / 8KA
V20X210E	210	270	320	15000	8000	1.2	16KV / 8KA
V20X230E	230	300	360	15000	8000	1.2	16KV / 8KA
V20X250E	250	320	390	15000	8000	1.2	16KV / 8KA
V20X275E	275	350	430	15000	8000	1.2	16KV / 8KA
V20X300E	300	385	500	15000	8000	1.2	16KV / 8KA
V20X320E	320	410	546	15000	8000	1.2	16KV / 8KA
V20X330E	330	435	546	15000	8000	1.2	16KV / 8KA
V20X350E	350	450	546	15000	8000	1.2	16KV / 8KA
V20X385E	385	505	546	15000	8000	1.2	16KV / 8KA
V20X420E	420	560	546	15000	8000	1.2	16KV / 8KA
V20X440E	440	585	560	15000	8000	1.2	16KV / 8KA
V20X460E	460	615	600	15000	8000	1.2	16KV / 8KA
V20X510E	510	670	650	15000	8000	1.2	16KV / 8KA
V20X550E	550	745	720	15000	8000	1.2	16KV / 8KA
V20X625E	625	825	800	15000	8000	1.2	16KV / 8KA
V20X680E	680	895	880	15000	8000	1.2	16KV / 8KA

Xtreme Varistor Series

Radial Leaded Varistors

Electrical Characteristics Under 25 °C

Part Number	Branding	Varistor Voltage at 1 mA DC	Varistor Voltage Shift at 1 mA	Clamping Voltage (8/20 μ s)		Typical Capacitance at 1 kHz
		V_n (V)	%	V_C (V)	I_{PK} (A)	C_{TYP} (pF)
V05X130E	5X130	205	± 10	340	10	130
V05X140E	5X140	220	± 10	360	10	120
V05X150E	5X150	240	± 10	395	10	110
V05X175E	5X175	270	± 10	455	10	100
V05X195E	5X195	300	± 10	495	10	95
V05X210E	5X210	330	± 10	545	10	90
V05X230E	5X230	360	± 10	595	10	80
V05X250E	5X250	390	± 10	650	10	75
V05X275E	5X275	430	± 10	710	10	70
V05X300E	5X300	470	± 10	775	10	65
V07X130E	7X130	205	± 10	340	25	260
V07X140E	7X140	220	± 10	360	25	240
V07X150E	7X150	240	± 10	395	25	230
V07X175E	7X175	270	± 10	455	25	210
V07X195E	7X195	300	± 10	495	25	190
V07X210E	7X210	330	± 10	545	25	180
V07X230E	7X230	360	± 10	595	25	170
V07X250E	7X250	390	± 10	650	25	160
V07X275E	7X275	430	± 10	710	25	150
V07X300E	7X300	470	± 10	775	25	140
V07X320E	7X320	510	± 10	845	25	130
V07X330E	7X330	530	± 10	875	25	120
V07X350E	7X350	560	± 10	930	25	115
V07X385E	7X385	620	± 10	1025	25	110
V07X420E	7X420	680	± 10	1120	25	110
V07X440E	7X440	710	± 10	1180	25	110
V10X130E	10X130	205	± 10	340	50	580
V10X140E	10X140	220	± 10	360	50	540
V10X150E	10X150	240	± 10	395	50	500
V10X175E	10X175	270	± 10	455	50	440
V10X195E	10X195	300	± 10	495	50	400
V10X210E	10X210	330	± 10	545	50	370
V10X230E	10X230	360	± 10	595	50	340
V10X250E	10X250	390	± 10	650	50	320
V10X275E	10X275	430	± 10	710	50	290
V10X300E	10X300	470	± 10	775	50	270
V10X320E	10X320	510	± 10	845	50	250
V10X330E	10X330	530	± 10	875	50	240
V10X350E	10X350	560	± 10	930	50	230
V10X385E	10X385	620	± 10	1025	50	210
V10X420E	10X420	680	± 10	1120	50	200
V10X440E	10X440	710	± 10	1180	50	190
V10X460E	10X460	750	± 10	1240	50	180

Xtreme Varistor Series

Radial Leaded Varistors

Electrical Characteristics Under 25 °C

Part Number	Branding	Varistor Voltage at 1 mA DC	Varistor Voltage Shift at 1 mA	Clamping Voltage (8/20 μ s)		Typical Capacitance at 1 kHz
		V_n (V)	%	V_c (V)	I_{PK} (A)	C_{TYP} (pF)
V10X510E	10X510	820	± 10	1355	50	170
V10X550E	10X550	910	± 10	1500	50	150
V10X625E	10X625	1000	± 10	1650	50	140
V10X680E	10X680	1100	± 10	1815	50	130
V11X130E	11X130	205	± 10	340	50	690
V11X140E	11X140	220	± 10	360	50	660
V11X150E	11X150	240	± 10	395	50	620
V11X175E	11X175	270	± 10	455	50	550
V11X195E	11X195	300	± 10	495	50	500
V11X210E	11X210	330	± 10	545	50	450
V11X230E	11X230	360	± 10	595	50	410
V11X250E	11X250	390	± 10	650	50	390
V11X275E	11X275	430	± 10	710	50	350
V11X300E	11X300	470	± 10	775	50	330
V11X320E	11X320	510	± 10	845	50	320
V11X330E	11X330	530	± 10	875	50	290
V11X350E	11X350	560	± 10	930	50	270
V11X385E	11X385	620	± 10	1025	50	250
V11X420E	11X420	680	± 10	1120	50	230
V11X440E	11X440	710	± 10	1180	50	220
V11X460E	11X460	750	± 10	1240	50	210
V11X510E	11X510	820	± 10	1355	50	200
V11X550E	11X550	910	± 10	1500	50	170
V11X625E	11X625	1000	± 10	1650	50	160
V11X680E	11X680	1100	± 10	1815	50	150
V14X130E	14X130	205	± 10	340	100	1200
V14X140E	14X140	220	± 10	360	100	1100
V14X150E	14X150	240	± 10	395	100	1050
V14X175E	14X175	270	± 10	455	100	950
V14X195E	14X195	300	± 10	495	100	850
V14X210E	14X210	330	± 10	545	100	800
V14X230E	14X230	360	± 10	595	100	700
V14X250E	14X250	390	± 10	650	100	700
V14X275E	14X275	430	± 10	710	100	600
V14X300E	14X300	470	± 10	775	100	600
V14X320E	14X320	510	± 10	845	100	500
V14X330E	14X330	530	± 10	875	100	500
V14X350E	14X350	560	± 10	930	100	500
V14X385E	14X385	620	± 10	1025	100	450
V14X420E	14X420	680	± 10	1120	100	400
V14X440E	14X440	710	± 10	1180	100	400
V14X460E	14X460	750	± 10	1240	100	400
V14X510E	14X510	820	± 10	1355	100	350

Xtreme Varistor Series

Radial Led Varistors

Electrical Characteristics Under 25 °C

Part Number	Branding	Varistor Voltage at 1 mA DC	Varistor Voltage Shift at 1 mA	Clamping Voltage (8/20 μs)		Typical Capacitance at 1 kHz
		V _n (V)	%	V _c (V)	I _{pk} (A)	C _{typ} (pF)
V14X550E	14X550	910	± 10	1500	100	300
V14X625E	14X625	1000	± 10	1650	100	300
V14X680E	14X680	1100	± 10	1815	100	250
V20X130E	20X130	205	± 10	340	100	2200
V20X140E	20X140	220	± 10	360	100	2100
V20X150E	20X150	240	± 10	395	100	1900
V20X175E	20X175	270	± 10	455	100	1700
V20X195E	20X195	300	± 10	495	100	1600
V20X210E	20X210	330	± 10	545	100	1400
V20X230E	20X230	360	± 10	595	100	1300
V20X250E	20X250	390	± 10	650	100	1200
V20X275E	20X275	430	± 10	710	100	1100
V20X300E	20X300	470	± 10	775	100	1000
V20X320E	20X320	510	± 10	845	100	1000
V20X330E	20X330	530	± 10	875	100	900
V20X350E	20X350	560	± 10	930	100	900
V20X385E	20X385	620	± 10	1025	100	800
V20X420E	20X420	680	± 10	1120	100	700
V20X440E	20X440	710	± 10	1180	100	700
V20X460E	20X460	750	± 10	1240	100	700
V20X510E	20X510	820	± 10	1355	100	600
V20X550E	20X550	910	± 10	1500	100	600
V20X625E	20X625	1000	± 10	1650	100	500
V20X680E	20X680	1100	± 10	1815	100	500

General Technical Data

Operating temperature	-40 to +125 °C
Storage temperature	-40 to +150 °C
Electric strength (Voltage Rating)	≥ 2.5 K _{v,rms}
Insulation resistance	≥ 1000 MΩ

Current Energy and Power Dissipation Ratings

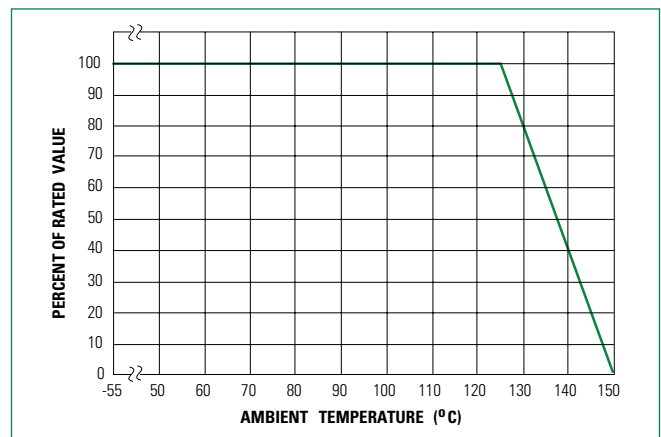

Note: The peak surge current and energy rating must be reduced for applications exceeding 125°C ambient

Xtreme Varistor Series

Radial Led Varistors

Transient V-I Characteristics Curves

Maximum Clamping Voltage for 5mm Parts

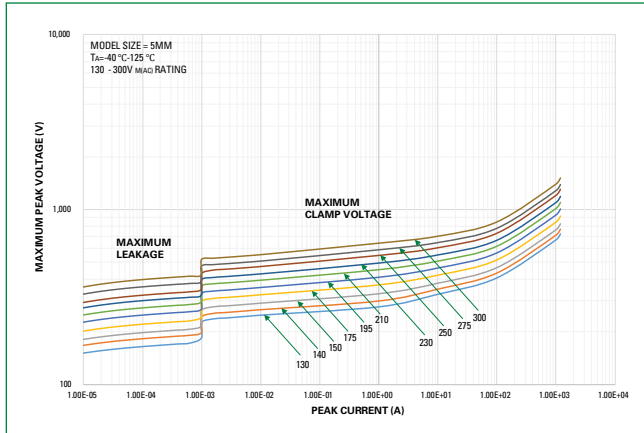

Maximum Clamping Voltage for 7mm Parts

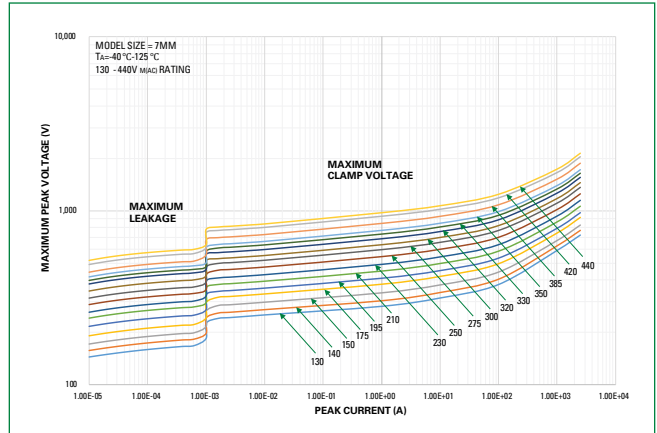

Maximum Clamping Voltage for 10mm Parts

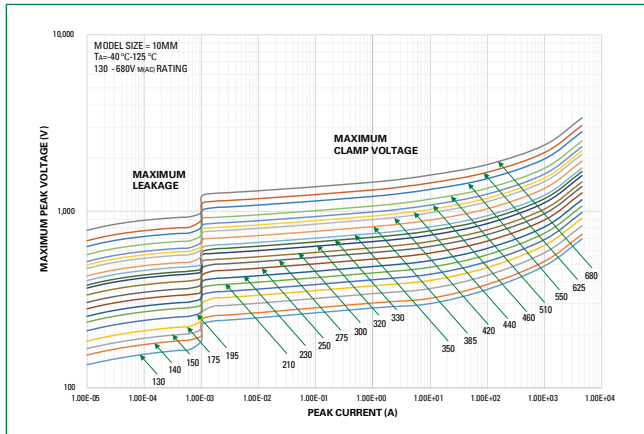

Maximum Clamping Voltage for 11mm Parts

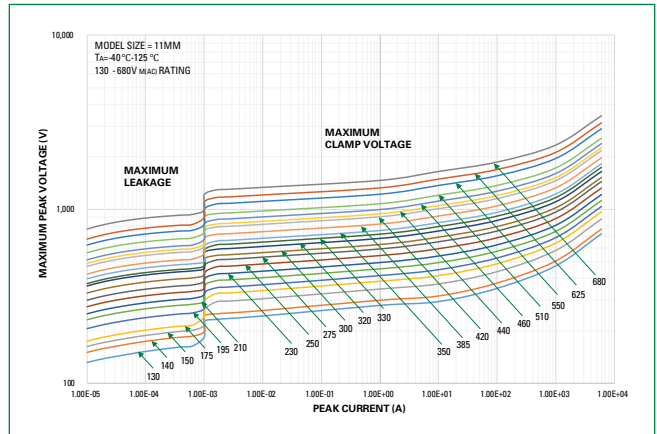

Maximum Clamping Voltage for 14mm Parts

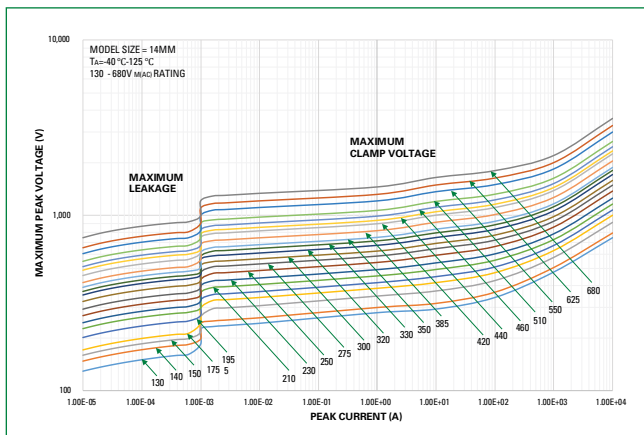

Maximum Clamping Voltage for 20mm Parts

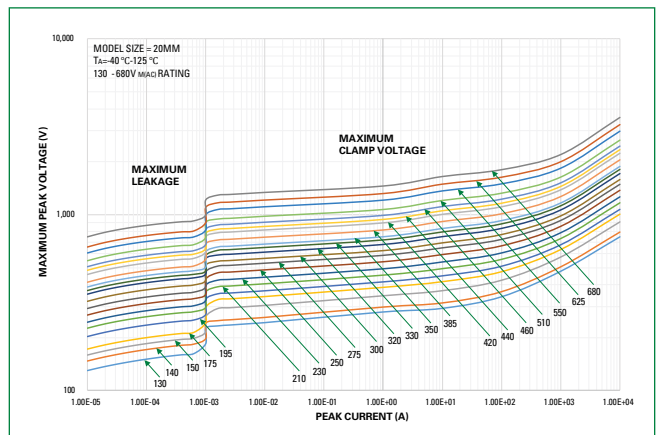

Xtreme Varistor Series

Radial Leded Varistors

Pulse Rating Curve

Repetitive Surge Capability for 5mm Parts

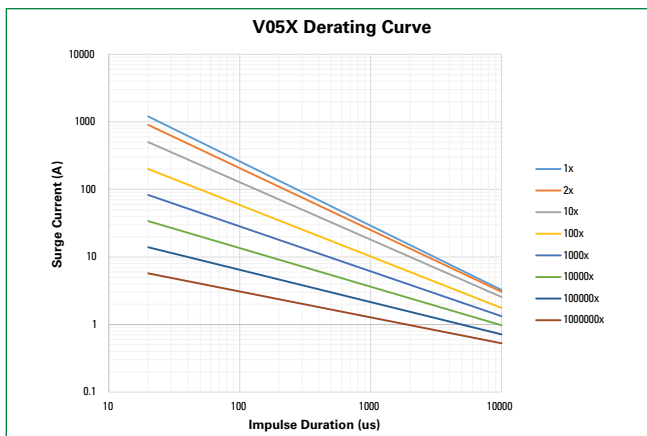

Repetitive Surge Capability for 7mm Parts

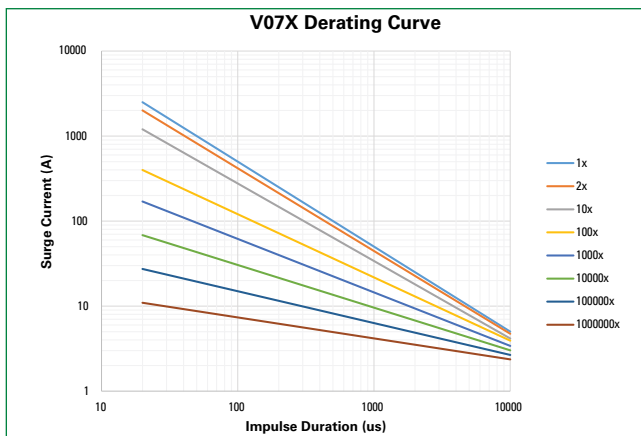

Repetitive Surge Capability for 10mm Parts

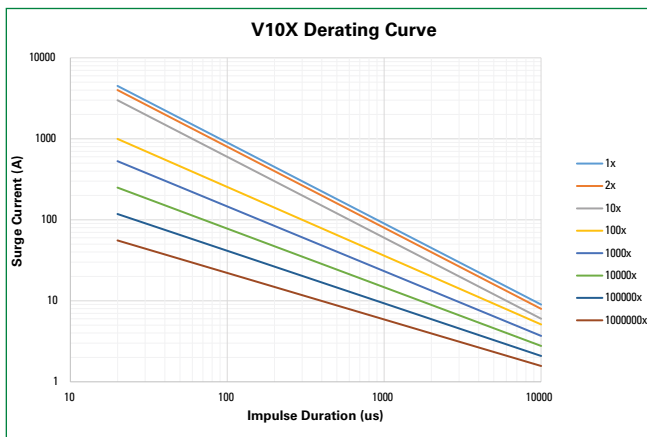

Repetitive Surge Capability for 11mm Parts

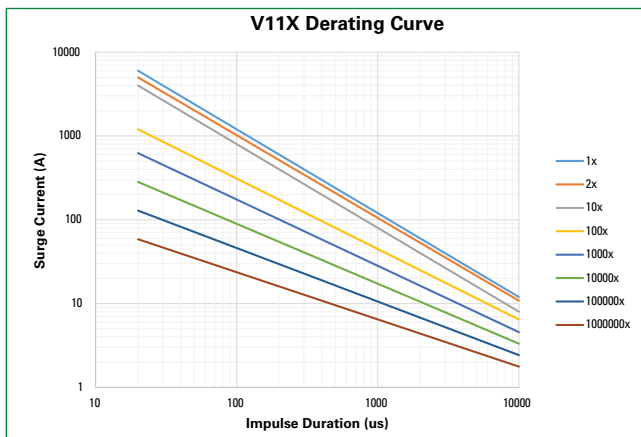

Repetitive Surge Capability for 14mm Parts

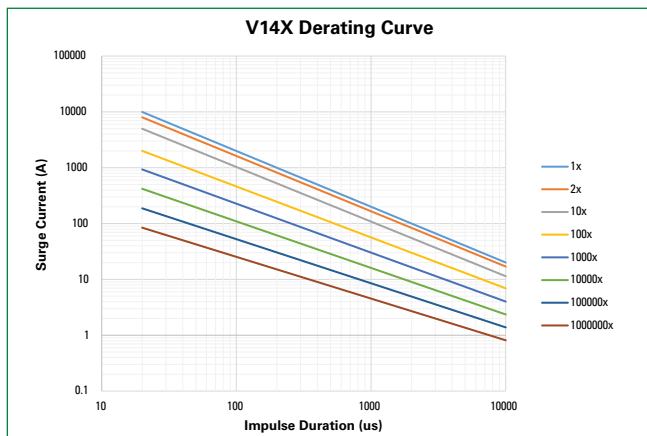

Repetitive Surge Capability for 20mm Parts

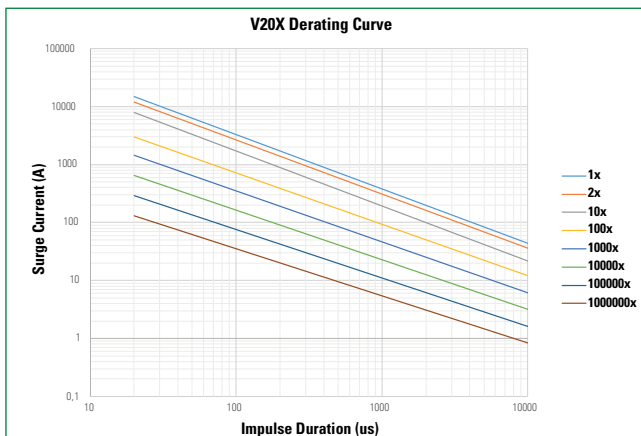

Xtreme Varistor Series

Radial Leaded Varistors

Product Dimensions (mm)

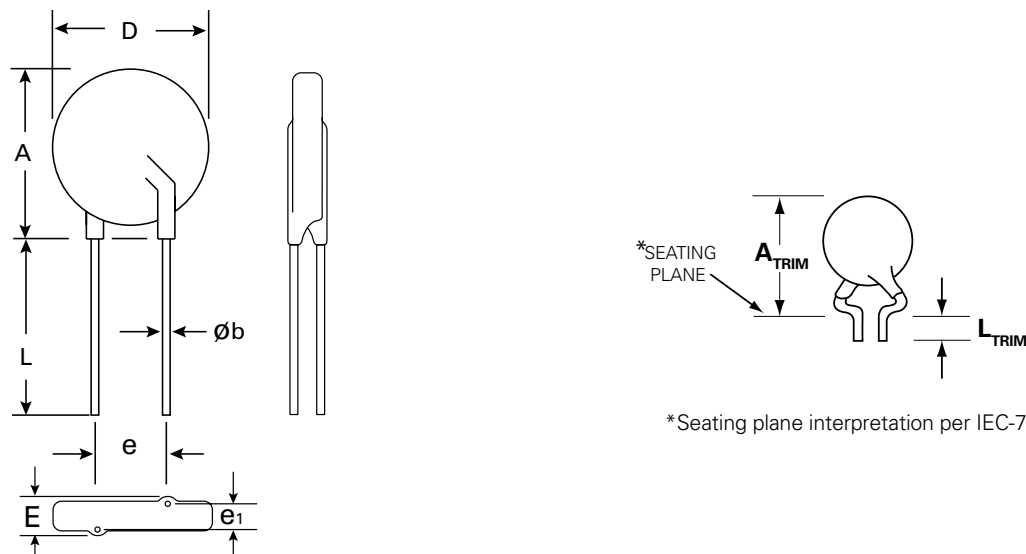

*Seating plane interpretation per IEC-717

Part Number	A _{Max}	A _{TRIM Max}	øb	D _{Max}	e	e1 (typ)	E _{Max}	L _{Min} (bulk packaging only)
V05X130E	10	13	0.60 ± 0.05	7	5 ± 1.0	2.0 ± 1.0	4.8	25.4
V05X140E	10	13	0.60 ± 0.05	7	5 ± 1.0	2.1 ± 1.0	4.9	25.4
V05X150E	10	13	0.60 ± 0.05	7	5 ± 1.0	2.2 ± 1.0	5.0	25.4
V05X175E	10	13	0.60 ± 0.05	7	5 ± 1.0	2.3 ± 1.0	5.1	25.4
V05X195E	10	13	0.60 ± 0.05	7	5 ± 1.0	2.5 ± 1.0	5.3	25.4
V05X210E	10	13	0.60 ± 0.05	7	5 ± 1.0	2.7 ± 1.0	5.5	25.4
V05X230E	10	13	0.60 ± 0.05	7	5 ± 1.0	2.9 ± 1.0	5.7	25.4
V05X250E	10	13	0.60 ± 0.05	7	5 ± 1.0	3.0 ± 1.0	5.8	25.4
V05X275E	10	13	0.60 ± 0.05	7	5 ± 1.0	3.3 ± 1.0	6.1	25.4
V05X300E	10	13	0.60 ± 0.05	7	5 ± 1.0	3.5 ± 1.0	6.3	25.4
V07X130E	12.5	15	0.60 ± 0.05	9	5 ± 1.0	2.0 ± 1.0	4.9	25.4
V07X140E	12.5	15	0.60 ± 0.05	9	5 ± 1.0	2.1 ± 1.0	5.0	25.4
V07X150E	12.5	15	0.60 ± 0.05	9	5 ± 1.0	2.2 ± 1.0	5.1	25.4
V07X175E	12.5	15	0.60 ± 0.05	9	5 ± 1.0	2.4 ± 1.0	5.3	25.4
V07X195E	12.5	15	0.60 ± 0.05	9	5 ± 1.0	2.6 ± 1.0	5.5	25.4
V07X210E	12.5	15	0.60 ± 0.05	9	5 ± 1.0	2.7 ± 1.0	5.6	25.4
V07X230E	12.5	15	0.60 ± 0.05	9	5 ± 1.0	2.9 ± 1.0	5.8	25.4
V07X250E	12.5	15	0.60 ± 0.05	9	5 ± 1.0	3.1 ± 1.0	6.0	25.4
V07X275E	12.5	15	0.60 ± 0.05	9	5 ± 1.0	3.3 ± 1.0	6.2	25.4
V07X300E	12.5	15	0.60 ± 0.05	9	5 ± 1.0	3.6 ± 1.0	6.5	25.4
V07X320E	12.5	15	0.60 ± 0.05	9	5 ± 1.0	3.8 ± 1.0	6.7	25.4
V07X330E	12.5	15	0.60 ± 0.05	9	5 ± 1.0	3.9 ± 1.0	6.8	25.4
V07X350E	12.5	15	0.60 ± 0.05	9	5 ± 1.0	4.1 ± 1.0	7.0	25.4
V07X385E	12.5	15	0.60 ± 0.05	9	5 ± 1.0	4.4 ± 1.0	7.3	25.4
V07X420E	12.5	15	0.60 ± 0.05	9	5 ± 1.0	4.8 ± 1.0	7.7	25.4
V07X440E	12.5	15	0.60 ± 0.05	9	5 ± 1.0	5.0 ± 1.0	7.9	25.4
V10X130E	16	19.5	0.80 ± 0.05	12.5	7.5 ± 1.0	2.0 ± 1.0	5.3	25.4
V10X140E	16	19.5	0.80 ± 0.05	12.5	7.5 ± 1.0	2.1 ± 1.0	5.4	25.4

Xtreme Varistor Series

Radial Leaded Varistors

Part Number	A _{Max}	A _{TRIM Max}	Øb	D _{Max}	e	e1 (typ)	E _{Max}	L _{Min} (bulk packaging only)
V10X150E	16	19.5	0.80 ± 0.05	12.5	7.5 ± 1.0	2.2 ± 1.0	5.5	25.4
V10X175E	16	19.5	0.80 ± 0.05	12.5	7.5 ± 1.0	2.4 ± 1.0	5.7	25.4
V10X195E	16	19.5	0.80 ± 0.05	12.5	7.5 ± 1.0	2.6 ± 1.0	5.9	25.4
V10X210E	16	19.5	0.80 ± 0.05	12.5	7.5 ± 1.0	2.7 ± 1.0	6.0	25.4
V10X230E	16	19.5	0.80 ± 0.05	12.5	7.5 ± 1.0	2.9 ± 1.0	6.2	25.4
V10X250E	16	19.5	0.80 ± 0.05	12.5	7.5 ± 1.0	3.1 ± 1.0	6.3	25.4
V10X275E	16	19.5	0.80 ± 0.05	12.5	7.5 ± 1.0	3.3 ± 1.0	6.5	25.4
V10X300E	16	19.5	0.80 ± 0.05	12.5	7.5 ± 1.0	3.6 ± 1.0	6.8	25.4
V10X320E	16	19.5	0.80 ± 0.05	12.5	7.5 ± 1.0	3.8 ± 1.0	7.0	25.4
V10X330E	16	19.5	0.80 ± 0.05	12.5	7.5 ± 1.0	3.9 ± 1.0	7.2	25.4
V10X350E	16	19.5	0.80 ± 0.05	12.5	7.5 ± 1.0	4.1 ± 1.0	7.4	25.4
V10X385E	16	19.5	0.80 ± 0.05	12.5	7.5 ± 1.0	4.4 ± 1.0	7.8	25.4
V10X420E	16	19.5	0.80 ± 0.05	12.5	7.5 ± 1.0	4.8 ± 1.0	8.1	25.4
V10X440E	16	19.5	0.80 ± 0.05	12.5	7.5 ± 1.0	5.0 ± 1.0	8.3	25.4
V10X460E	16	19.5	0.80 ± 0.05	12.5	7.5 ± 1.0	5.2 ± 1.0	8.6	25.4
V10X510E	16	19.5	0.80 ± 0.05	12.5	7.5 ± 1.0	5.6 ± 1.0	8.9	25.4
V10X550E	16	19.5	0.80 ± 0.05	12.5	7.5 ± 1.0	6.2 ± 1.0	9.5	25.4
V10X625E	16	19.5	0.80 ± 0.05	12.5	7.5 ± 1.0	6.7 ± 1.0	10.0	25.4
V10X680E	16	19.5	0.80 ± 0.05	12.5	7.5 ± 1.0	7.3 ± 1.0	10.6	25.4
V11X130E	18	20.5	0.80 ± 0.05	14	7.5 ± 1.0	2.0 ± 1.0	5.3	25.4
V11X140E	18	20.5	0.80 ± 0.05	14	7.5 ± 1.0	2.1 ± 1.0	5.4	25.4
V11X150E	18	20.5	0.80 ± 0.05	14	7.5 ± 1.0	2.2 ± 1.0	5.5	25.4
V11X175E	18	20.5	0.80 ± 0.05	14	7.5 ± 1.0	2.4 ± 1.0	5.7	25.4
V11X195E	18	20.5	0.80 ± 0.05	14	7.5 ± 1.0	2.6 ± 1.0	5.9	25.4
V11X210E	18	20.5	0.80 ± 0.05	14	7.5 ± 1.0	2.7 ± 1.0	6.0	25.4
V11X230E	18	20.5	0.80 ± 0.05	14	7.5 ± 1.0	2.9 ± 1.0	6.2	25.4
V11X250E	18	20.5	0.80 ± 0.05	14	7.5 ± 1.0	3.1 ± 1.0	6.3	25.4
V11X275E	18	20.5	0.80 ± 0.05	14	7.5 ± 1.0	3.3 ± 1.0	6.5	25.4
V11X300E	18	20.5	0.80 ± 0.05	14	7.5 ± 1.0	3.6 ± 1.0	6.8	25.4
V11X320E	18	20.5	0.80 ± 0.05	14	7.5 ± 1.0	3.8 ± 1.0	7.0	25.4
V11X330E	18	20.5	0.80 ± 0.05	14	7.5 ± 1.0	3.9 ± 1.0	7.2	25.4
V11X350E	18	20.5	0.80 ± 0.05	14	7.5 ± 1.0	4.1 ± 1.0	7.4	25.4
V11X385E	18	20.5	0.80 ± 0.05	14	7.5 ± 1.0	4.4 ± 1.0	7.8	25.4
V11X420E	18	20.5	0.80 ± 0.05	14	7.5 ± 1.0	4.8 ± 1.0	8.1	25.4
V11X440E	18	20.5	0.80 ± 0.05	14	7.5 ± 1.0	5.0 ± 1.0	8.3	25.4
V11X460E	18	20.5	0.80 ± 0.05	14	7.5 ± 1.0	5.2 ± 1.0	8.6	25.4
V11X510E	18	20.5	0.80 ± 0.05	14	7.5 ± 1.0	5.6 ± 1.0	8.9	25.4
V11X550E	18	20.5	0.80 ± 0.05	14	7.5 ± 1.0	6.2 ± 1.0	9.5	25.4
V11X625E	18	20.5	0.80 ± 0.05	14	7.5 ± 1.0	6.7 ± 1.0	10.0	25.4
V11X680E	18	20.5	0.80 ± 0.05	14	7.5 ± 1.0	7.3 ± 1.0	10.6	25.4
V14X130E	20	22.5	0.80 ± 0.05	17	7.5 ± 1.0	2.0 ± 1.0	5.3	25.4
V14X140E	20	22.5	0.80 ± 0.05	17	7.5 ± 1.0	2.1 ± 1.0	5.4	25.4
V14X150E	20	22.5	0.80 ± 0.05	17	7.5 ± 1.0	2.2 ± 1.0	5.5	25.4
V14X175E	20	22.5	0.80 ± 0.05	17	7.5 ± 1.0	2.4 ± 1.0	5.7	25.4
V14X195E	20	22.5	0.80 ± 0.05	17	7.5 ± 1.0	2.6 ± 1.0	5.9	25.4
V14X210E	20	22.5	0.80 ± 0.05	17	7.5 ± 1.0	2.7 ± 1.0	6.0	25.4

Xtreme Varistor Series

Radial Leaded Varistors

Part Number	A _{Max}	A _{TRIM Max}	Øb	D _{Max}	e	e1 (typ)	E _{Max}	L _{Min} (bulk packaging only)
V14X230E	20	22.5	0.80 ± 0.05	17	7.5 ± 1.0	2.9 ± 1.0	6.2	25.4
V14X250E	20	22.5	0.80 ± 0.05	17	7.5 ± 1.0	3.1 ± 1.0	6.3	25.4
V14X275E	20	22.5	0.80 ± 0.05	17	7.5 ± 1.0	3.3 ± 1.0	6.5	25.4
V14X300E	20	22.5	0.80 ± 0.05	17	7.5 ± 1.0	3.6 ± 1.0	6.8	25.4
V14X320E	20	22.5	0.80 ± 0.05	17	7.5 ± 1.0	3.8 ± 1.0	7.0	25.4
V14X330E	20	22.5	0.80 ± 0.05	17	7.5 ± 1.0	3.9 ± 1.0	7.2	25.4
V14X350E	20	22.5	0.80 ± 0.05	17	7.5 ± 1.0	4.1 ± 1.0	7.4	25.4
V14X385E	20.5	22.5	0.80 ± 0.05	17	7.5 ± 1.0	4.4 ± 1.0	7.8	25.4
V14X420E	20.5	22.5	0.80 ± 0.05	17	7.5 ± 1.0	4.8 ± 1.0	8.1	25.4
V14X440E	20.5	22.5	0.80 ± 0.05	17	7.5 ± 1.0	5.0 ± 1.0	8.3	25.4
V14X460E	20.5	22.5	0.80 ± 0.05	17	7.5 ± 1.0	5.2 ± 1.0	8.6	25.4
V14X510E	20.5	22.5	0.80 ± 0.05	17	7.5 ± 1.0	5.6 ± 1.0	8.9	25.4
V14X550E	20.5	22.5	0.80 ± 0.05	17	7.5 ± 1.0	6.2 ± 1.0	9.5	25.4
V14X625E	20.5	22.5	0.80 ± 0.05	17	7.5 ± 1.0	6.7 ± 1.0	10.0	25.4
V14X680E	20.5	22.5	0.80 ± 0.05	17	7.5 ± 1.0	7.3 ± 1.0	10.6	25.4
V20X130E	28	29	1.0 ± 0.05	23	10 ± 1.0	2.5 ± 1.0	5.8	25.4
V20X140E	28	29	1.0 ± 0.05	23	10 ± 1.0	2.6 ± 1.0	5.9	25.4
V20X150E	28	29	1.0 ± 0.05	23	10 ± 1.0	2.7 ± 1.0	6.0	25.4
V20X175E	28	29	1.0 ± 0.05	23	10 ± 1.0	2.9 ± 1.0	6.2	25.4
V20X195E	28	29	1.0 ± 0.05	23	10 ± 1.0	3.1 ± 1.0	6.4	25.4
V20X210E	28	29	1.0 ± 0.05	23	10 ± 1.0	3.3 ± 1.0	6.6	25.4
V20X230E	28	29	1.0 ± 0.05	23	10 ± 1.0	3.5 ± 1.0	6.8	25.4
V20X250E	28	29	1.0 ± 0.05	23	10 ± 1.0	3.6 ± 1.0	6.9	25.4
V20X275E	28	29	1.0 ± 0.05	23	10 ± 1.0	3.9 ± 1.0	7.2	25.4
V20X300E	28	29	1.0 ± 0.05	23	10 ± 1.0	4.1 ± 1.0	7.4	25.4
V20X320E	28	29	1.0 ± 0.05	23	10 ± 1.0	4.4 ± 1.0	7.7	25.4
V20X330E	28	29	1.0 ± 0.05	23	10 ± 1.0	4.5 ± 1.0	7.8	25.4
V20X350E	28	29	1.0 ± 0.05	23	10 ± 1.0	4.7 ± 1.0	8.0	25.4
V20X385E	28	29	1.0 ± 0.05	23	10 ± 1.0	5.1 ± 1.0	8.4	25.4
V20X420E	28	29	1.0 ± 0.05	23	10 ± 1.0	5.5 ± 1.0	8.8	25.4
V20X440E	28	29	1.0 ± 0.05	23	10 ± 1.0	5.6 ± 1.0	8.9	25.4
V20X460E	28	29	1.0 ± 0.05	23	10 ± 1.0	5.9 ± 1.0	9.2	25.4
V20X510E	28	29	1.0 ± 0.05	23	10 ± 1.0	6.3 ± 1.0	9.6	25.4
V20X550E	28	29	1.0 ± 0.05	23	10 ± 1.0	6.9 ± 1.0	10.2	25.4
V20X625E	28	29	1.0 ± 0.05	23	10 ± 1.0	7.5 ± 1.0	10.8	25.4
V20X680E	28	29	1.0 ± 0.05	23	10 ± 1.0	8.1 ± 1.0	11.4	25.4

Note

- "L" is measured as the shortest distance between the endpoint of epoxy coating and the endpoint of wire lead when facing MOV marking side.

Xtreme Varistor Series

Radial Leaded Varistors

Electrical Reliability

Test Item	Reference Standard	Test methods/Description	Specification Limit
Varistor Voltage (Vn or Uv)	IEC 61051-1	The voltage between the varistor leads with the measuring current of 1 mADC @ 30 ms	To meet the specified value
Clamping Voltage	IEC 61051-1	The voltage measured across the varistor leads with the specified impulse current during the application of an 8/20 μ s current waveform	To meet the specified value
Maximum Peak Current	IEC 61051-1	The maximum current that can be passed by a varistor with one pulse of 8/20 μ s waveform at ambient temperature of 25 °C	$ \Delta V_n/V_n \leq 10\%$ (measured in direction of surge current); No visible damage
Rated Energy	IEC 61051-1	The rated energy that the varistor is able to withstand one pulse when it is exposed to 2 ms rectangular waveform (or 10/1000 μ s waveform) at ambient temperature of 25 °C	$ \Delta V_n/V_n \leq 10\%$ (measured in direction of surge current); No visible damage
Combination Pulse	IEC 61051-2	Voltage 1.2/50 μ s, Current 8/20 μ s with V_{RMS} MCOV applied, 10 pulses in one direction, one pulse per minute	$ \Delta V_n/V_n \leq 10\%$ (measured in direction of surge current); No visible damage
Nominal Discharge Current	UL 1449	8/20 μ s waveform with V_{RMS} MCOV applied, 15 pulses in 3 groups (30 minutes interval between every two groups, 1 minute interval between every two pulses)	$ \Delta V_n/V_n \leq 10\%$ (measured in direction of surge current); No visible damage
Endurance at Upper Category Temperature	IEC 61051-1	After having continuously applied V_{RMS} MCOV at 125 ± 2 °C for 1000 hours, the specimen shall be stored at room temperature and normal humidity for 1 to 2 hours. Thereafter, the change of Vn shall be measured	$ \Delta V_n/V_n \leq 10\%$; No visible damage
Voltage Proof	IEC 61051-1	Metal balls method, 2500 Vac for 60 ± 5 seconds. The complete varistor is placed in a container holding metal balls with maximum 1.6 mm diameter such that only the terminations of the varistor are protruding. The specified voltage shall be applied between both terminations of the specimen connected together and the electrode inserted into the metal balls	No breakdown; No flashover
Rapid Change of Temperature	IEC 60068-2-14	Test Na. 5 cycles, -40 to 125 °C, dwell time 30 minutes at each extreme	$ \Delta V_n/V_n \leq 10\%$; No visible damage
Climatic Sequence	IEC 61051-1	The specimen shall be subjected to: a) Dry heat at +125 °C, 16 hours, in accordance with Test Bb of IEC 60068-2-2 b) Damp heat, 1st cycle: 55 °C, 93% RH, 24 hours, in accordance with Test Db of IEC 60068-2-30 c) Cold at -40 °C, 2 hours, in accordance with Test Ab of IEC 60068-2-1 d) Damp heat, additional 5 cycles: 55 °C, 93% RH, 24 h/cycle, in accordance with Test Db of IEC 60068-2-30. e) Specimen shall be stored at room temperature and normal humidity for 1 to 2 hours	$ \Delta V_n/V_n \leq 10\%$; No visible damage
High Temperature Storage (Dry Heat)	MIL-STD-202, Method 108A	In accordance with Test Condition D, 150 ± 3 °C for 1000hrs, without voltage applied. After completion of the test, the specimen shall be allowed to recover at room temperature for 1 to 2 hours	$ \Delta V_n/V_n \leq 10\%$; No visible damage
Damp Heat, Steady State	IEC 61051-1	Conducted in accordance with Test Cab of IEC 60068-2-78. The specimen are divided into two groups. Both groups shall be subjected to 40 ± 2 °C, 90 to 95% RH for 56 days with Group 1 without voltage applied and Group 2 with 10% of VDC MCOV. Both groups are then stored at room temperature and normal humidity for 1 to 2 hours	$ \Delta V_n/V_n \leq 10\%$; No visible damage

Xtreme Varistor Series

Radial Leaded Varistors

Test Item	Reference Standard	Test methods / Description	Specification Limit
Solderability	IEC 61051-1	In accordance with Test Ta, Method 1 (solder bath) of IEC 60068-2-20, Lead Free Solder (Sn96.5Ag3Cu.5): 245±3 °C, 3±0.3 seconds. After dipping the terminations to a depth of approximately 3 mm from the varistor body in a soldering bath of 245 °C for 3 seconds, the terminations shall be visually examined with normal eyesight or with the assistance of a magnifier capable of giving a magnification of 4X to 25X	At least 95% of the dipped surface is covered by new solder. No more than small amount of scattered imperfections such as pin-holes or un-wetted or de-wetted areas
Resistance to Soldering Heat	IEC 61051-1	In accordance with Test Tb, Method 1 (solder bath) of IEC 60068-2-20 shall be dipped into a solder bath having a temperature of 260±3 °C to a point 2.0~2.5 mm from varistor body of the specimen, be held there for 10 ±1 seconds, and then be stored at room temperature and normal humidity for 1 to 2 hours. Thereafter, the change of Vn shall be measured and the specimen shall be visually examined	$ \Delta V_n/V_n \leq 5\%$; No visible damage
Tensile Strength	IEC 61051-1	In accordance with Test Ua1 of IEC 60068-2-21 applying the force specified below and keeping the unit fixed for 10 seconds. Force for wire diameter: Ø 0.6 mm = 10 N Ø 0.8 mm = 10 N Ø 1.0 mm = 20 N	$ \Delta V_n/V_n \leq 5\%$; No break of solder joint, no wire break
Vibration	IEC 61051-1	After repeatedly applying a sinusoidal harmonic vibration as below, the change of Vn and mechanical damages shall be examined. Pulse shape: Sine wave Amplitude: 0.75 mm Pulse shape: Sine wave Amplitude: 0.75 mm Frequency range: 10 Hz to 55 Hz Duration: 6 hours (2 hours each, 3 directions)	$ \Delta V_n/V_n \leq 5\%$; No visible damage
Shock	IEC 61051-1	In accordance with Test Ea of IEC 60068-2-27. A half-sine pulse with 11 m/s ² duration and 490 m/s ² maximum acceleration shall be used. Three shocks in each axis (x, y, and z) and direction (positive and negative) were applied (totaling 36 shocks in total)	$ \Delta V_n/V_n \leq 5\%$; No visible damage
Fire Hazard	IEC 61051-1	Test methods/Description: Needle flame test method in accordance with IEC 60695-11-5 for a duration of 30 s	No ignition of MOV or ignition of underlying layer
Resistance to solvents	MIL-STD-202 Method 215K	Solvent 1, inspect at 3X maximum for marking; Inspect at 10X maximum for part damage	$ \Delta V_n/V_n \leq 5\%$; Marking visible; Coating not damaged

Note

- Nominal varistor voltage per UL 1449 is Vn and Uv per IEC 61051-1

Xtreme Varistor Series

Radial Leded Varistors

Part Numbering System

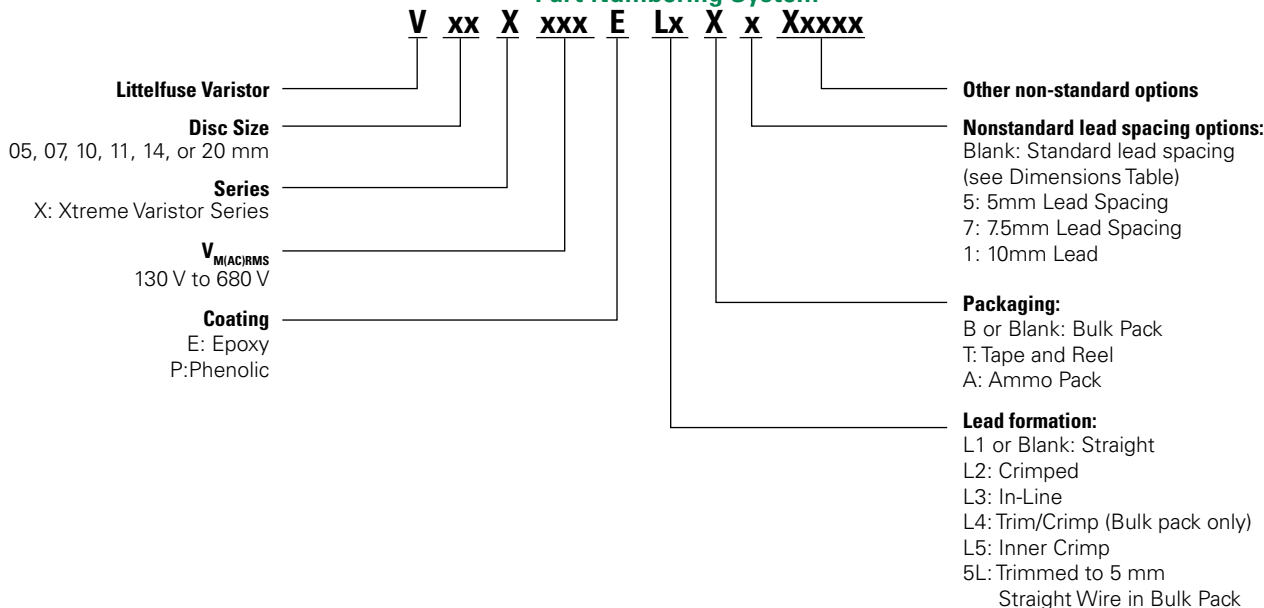

Tape Specifications for Reel and Ammo Pack Items

Straight Leads L1

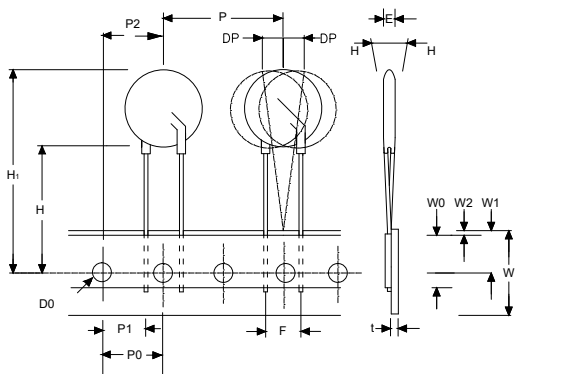

Crimped Leads L2

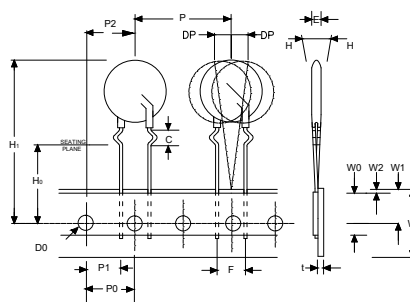

In-line Leads L3

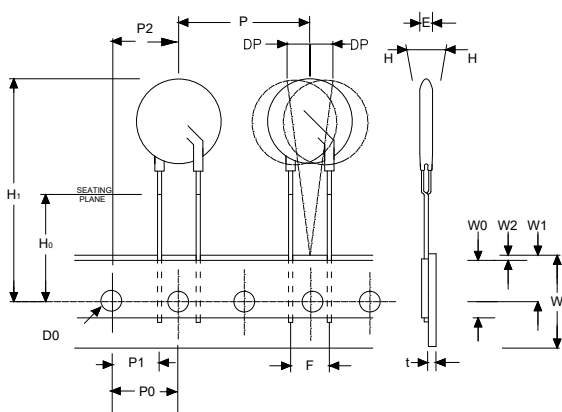

Inner Crimped Leads L5

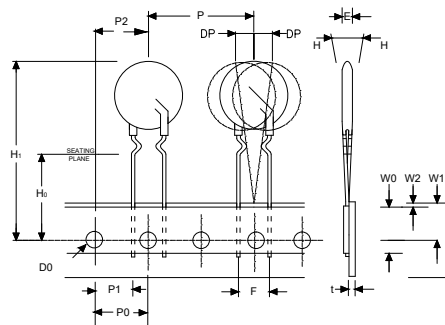

Note

- Confirms to ANSI and EIA specifications
- Can be supplied to IEC Publication 286-2
- Radial devices on tape are offered with crimped leads, straight leads, or on-line leads. See Ordering Information
- For 10 mm devices, 'P' (Component Pitch) is 12.7 mm, when 'F' (Lead Space) is 5 mm
- 5 mm and 7 mm parts are available on tape and reel up to 300 Vac only
- 10 mm and 11 mm parts are available on tape and reel up to 350 Vac only
- 14 mm and 20 mm parts are available on tape and reel up to 385 Vac only
- 7 mm devices with 7.5 mm lead spacing option will be taped at 25.4 mm component pitch and 500 pieces per reel
- 10 mm devices with 5.0 mm lead spacing option will be taped at 12.7 mm component pitch and 1000 pieces per reel

Xtreme Varistor Series

Radial Leaded Varistors

Symbol	Description	Model Size		
		5 mm	7 mm	10 mm
P	Pitch of Component	12.7 +/- 1.0	12.7 +/- 1.0	25.4 +/- 1.0
P0	Feed Hole Pitch	12.7 +/- 0.2	12.7 +/- 0.2	12.7 +/- 0.2
P1	Feed Hole center to Pitch	3.85 +/- 0.7	3.85 +/- 0.7	8.85 +/- 0.7
P2	Hole Center to Component Center	6.35 +/- 0.7	6.35 +/- 0.7	12.7 +/- 0.7
F	Lead to Lead Distance	5.0 +/- 1.0	5.0 +/- 1.0	7.5 +/- 1.0
h	Component Alignment	2.0 Max	2.0 Max	2.0 Max
W	Tape Width	18.0 +1.0 / -0.5	18.0 +1.0 / -0.5	18.0 +1.0 / -0.5
W0	Hold Down Tape Width	12.0 +/- 0.3	12.0 +/- 0.3	12.0 +/- 0.3
W1	Hole Position	9.0 +0.75 / -0.50	9.0 +0.75 / -0.50	9.0 +0.75 / -0.50
W2	Hold Down Tape Position	0.5 Max	0.5 Max	0.5 Max
H	Height from Tape Center to Component Base	18.0 +2.0 / -0.0	18.0 +2.0 / -0.0	18.0 +2.0 / -0.0
H0	Seating Plane Height	16.0 +/- 0.5	16.0 +/- 0.5	16.0 +/- 0.5
H1	Component Height	29.0 Max	32.0 Max	36.0 Max
D0	Feed Hole Diameter	4.0 +/- 0.2	4.0 +/- 0.2	4.0 +/- 0.2
t	Total Tape Thickness	0.7 +/- 0.2	0.7 +/- 0.2	0.7 +/- 0.2
U	Undercrimp Width	8.0 Max	8.0 Max	8.0 Max
p	Component Alignment	3° Max	3° Max	3° Max

Symbol	Description	Model Size		
		11 mm	14 mm	20 mm
P	Pitch of Component	25.4 +/- 1.0	25.4 +/- 1.0	25.4 +/- 1.0
P0	Feed Hole Pitch	12.7 +/- 0.2	12.7 +/- 0.2	12.7 +/- 0.2
P1	Feed Hole center to Pitch	8.85 +/- 0.7	8.85 +/- 0.7	8.85 +/- 0.7
P2	Hole Center to Component Center	12.7 +/- 0.7	12.7 +/- 0.7	12.7 +/- 0.7
F	Lead to Lead Distance	7.5 +/- 1.0	7.5 +/- 1.0	7.5 +/- 1.0
h	Component Alignment	2.0 Max	2.0 Max	2.0 Max
W	Tape Width	18.0 +1.0 / -0.5	18.0 +1.0 / -0.5	18.0 +1.0 / -0.5
W0	Hold Down Tape Width	12.0 +/- 0.3	12.0 +/- 0.3	12.0 +/- 0.3
W1	Hole Position	9.0 +0.75 / -0.50	9.0 +0.75 / -0.50	9.0 +0.75 / -0.50
W2	Hold Down Tape Position	0.5 Max	0.5 Max	0.5 Max
H	Height from Tape Center to Component Base	18.0 +2.0 / -0.0	18.0 +2.0 / -0.0	18.0 +2.0 / -0.0
H0	Seating Plane Height	16.0 +/- 0.5	16.0 +/- 0.5	16.0 +/- 0.5
H1	Component Height	38.0 Max	40.0 Max	46.5 Max
D0	Feed Hole Diameter	4.0 +/- 0.2	4.0 +/- 0.2	4.0 +/- 0.2
t	Total Tape Thickness	0.7 +/- 0.2	0.7 +/- 0.2	0.7 +/- 0.2
U	Undercrimp Width	8.0 Max	8.0 Max	8.0 Max
p	Component Alignment	3° Max	3° Max	3° Max

Note

- For information on tape and reel packaging quantities, please refer to the Ordering Notes section at the end of this document.

Xtreme Varistor Series

Radial Leaded Varistors

Ordering Notes

For standard parts, use the **BASE PART** designator only.

For parts with non-standard options (such as additional form, packaging and lead space options) use,

BASE PART + OPTION CODE.

OPTION CODE items are subject to availability and minimum order requirements. Please contact a Littelfuse representative if you require additional information

OPTION CODES:

X2855: Nickel Barrier COATED WIRE OPTION

All standard parts use tinned copper clad steel wire. Nickel Barrier Coated Wire is available as an option, consisting of Copper Wire with a flashing of Nickel followed by a top coating of Tin.

To order: append standard model **BASE PART** number with "X2855." Example:

Standard Model	Order As
V14X320E	V14X320EX2855

PACKAGING:

Littelfuse Xtreme Varistor Series are shipped standard in bulk pack with straight leads and lead spacing outlined in the dimensions sections of this document. Contact a Littelfuse representative to discuss non-standard options.

Standard Bulk Pack Quantity

V_{RMS} MCOV	Standard Bulk Pack Quantity					
	5 mm	7 mm	10 mm	11 mm	14 mm	20 mm
130 – 175	1500	1500	1000	800	700	500
195 – 300	1500	1500	700	600	600	400
320 – 420	-	1500	700	600	500	400
440 - 680	-	-	300	250	200	150

Note: Standard bulk pack quantity of V20X385E, V20X420E and V20X440E are 300.

Tape and Reel Quantity

V_{RMS} MCOV	Shipping Quantity/Reel					
	5 mm	7 mm	10 mm	11 mm	14 mm	20 mm
130 – 175	1000	1000	500	500	500	500
195 – 420	1000	1000	500	400	400	400
440 - 680	-	-	-	-	-	-

Disclaimer Notice - Information furnished is believed to be accurate and reliable. However, users should independently evaluate the suitability of and test each product selected for their own applications. Littelfuse products are not designed for, and may not be used in, all applications. Read complete Disclaimer Notice at <http://www.littelfuse.com/disclaimer-electronics>.