

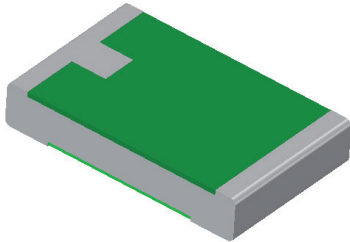

## ISA-PLAN® // PRECISION RESISTORS



### VMI // Size 0805



#### Features

- 0.5 W power rating at 100 °C
- Constant current up to 7 A (10 mOhm)
- Small size (0805)
- High pulse power rating
- Excellent long-term stability
- Mounting: Reflow- and IR-soldering
- RoHS 2011/65/EU compliant
- AEC-Q200 qualified



#### Applications

- Current sensor for power hybrid applications
- Control systems for the automotive market, amongst others for LED-applications
- Power modules
- Frequency converters
- Switch mode power supplies

#### Technical data

Resistance values	<b>mOhm</b>	10 / 12 / 20 / 30 / 50
Tolerance	<b>%</b>	5 / (1 <sup>1</sup> )
Temperature coefficient (20-60 °C)	<b>ppm/K</b>	<30 <sup>2</sup>
Applicable temperature range	<b>°C</b>	-65 to +170
Power rating	<b>W</b>	0.5
Internal heat resistance (R <sub>thi</sub> )	<b>K/W</b>	<80
Dielectric withstanding voltage	<b>V AC/DC</b>	200
Inductance	<b>nH</b>	<1
Stability (at rated power) deviation after 2000h, T <sub>K</sub> = Terminal temperature		<0.5 % (T <sub>K</sub> =100 °C) <1.0 % (T <sub>K</sub> =130 °C)

<sup>1</sup> please contact us

<sup>2</sup> R010, R012, R020: <50 ppm/K

#### Ordering code

VMI - R010 - 5.0

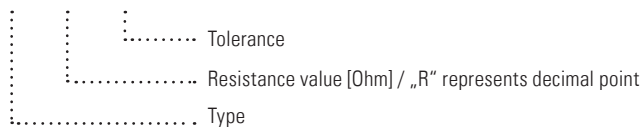



**VMI // Size 0805**

**Recommended solder profile**

Reflow- and IR-soldering				
Temperature	°C	260	255	217
Time	sec	peak	40	90

**Tape and reel information**

Specification		DIN EN 60286-3
Tape width	mm	8
Reel size	inch	13
Parts per reel	pcs	15000
Packaging weight (net)	g	480

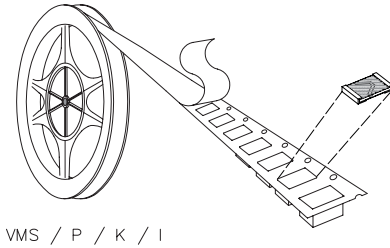

**Specification**

Parameters	Test conditions	Specified values
Temperature Cycling	2000 cycles (-55 °C to +150 °C)	±0.5 %
Temperature Cycling for VMI-R012	1000 cycles (-55 °C to +150 °C)	±0.5 %
Low Temperature Storage and Operation	-65 °C for 250 h	±0.1 %
Resistance to Soldering Heat	260 °C for 10 sec / 8h steam aging	±0.3 %
Moisture Resistance	MIL-STD-202 method 106	±0.5 %
Mechanical Shock	100 g, 6 ms half sine	±0.2 %
Vibration, High Frequency	10 g, 10-2000 Hz, 24 h each axis	±0.2 %
Operational Life	2000 h, T <sub>k</sub> max at rated power	±1.0 %, T <sub>k</sub> = 130 °C
High Temperature Exposure	2000 h / 170 °C	±1.0 %
Bias Humidity	+85 °C, 85 r.F., 1000 h, powered	±0.5 %



VMI // Size 0805

Temperature dependence of the electrical resistance

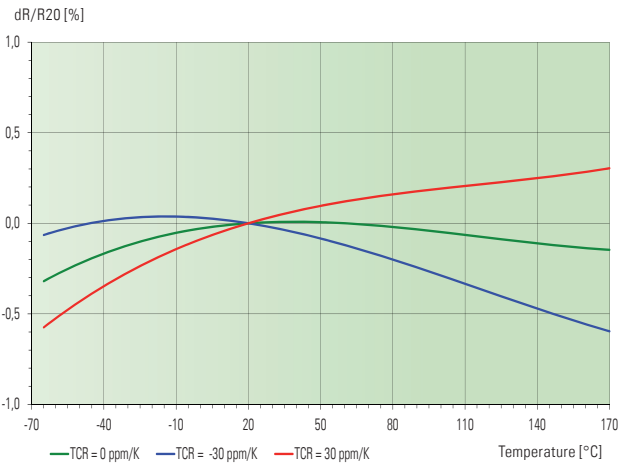

Power derating curve

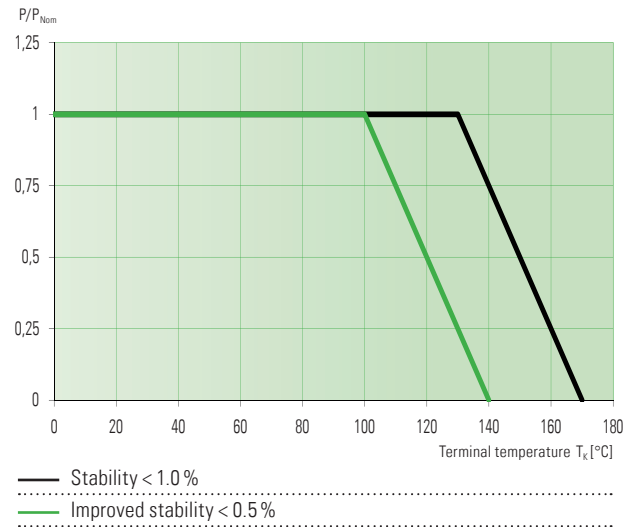

Mechanical dimensions and pcb-layout proposal (Reflow-soldering) [mm] // Z-YE-494a

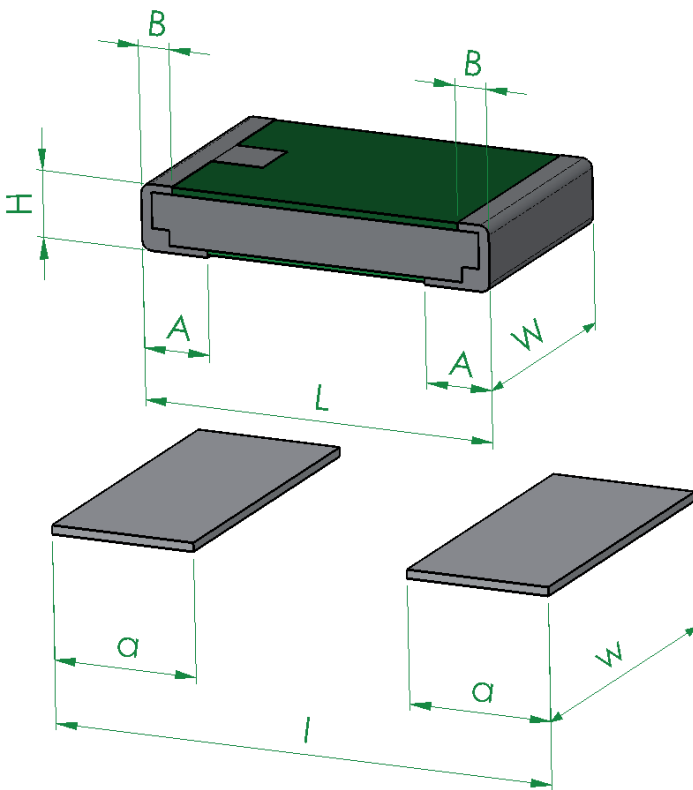

type:	L	W	H	A	B
VMI	2.03 ±0.15	1.27 ±0.15	0.4 ±0.15	0.38 ±0.1	0.18 +0.15/-0.1

solder pad type:	l	w	a
VMI	2.9	1.8	0.82



VMI // Size 0805

Maximum pulse energy respectively pulse power for permanent operation

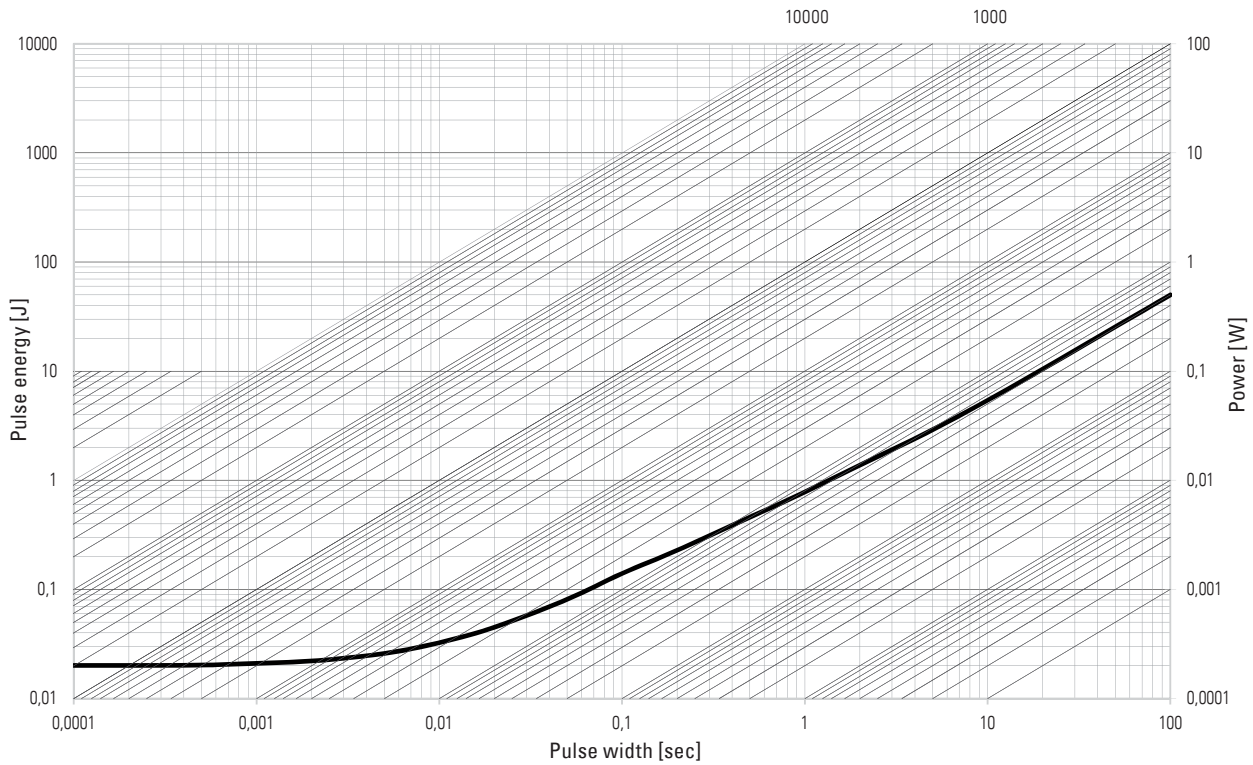

This curve is only valid for the resistance value R010. The shape of the curve in the range below 0.1 sec will be different for other resistance values. Therefore a separate qualification should be made for pulse power close to the above curve.

**Disclaimer //** All products, product specifications and data are subject to change without notice.

The product specifications do not expand or otherwise modify Isabellenhütte’s terms and conditions of sale, including but not limited to, the warranty expressed therein. Isabellenhütte makes no warranty, representation or guarantee other than as set forth in its terms and conditions of sale. Information provided in datasheets and/or specifications may vary from actual results in different applications. Any statements made by Isabellenhütte regarding the suitability of products for certain types of applications are based on its knowledge of typical requirements that are often placed on its products. It is the customer’s responsibility to validate that a particular product with the properties described in the product specification is suitable for use in the application intended.

No license, express or implied, or otherwise, to any intellectual property rights is granted by this document.

Any and all liability arising out of the application or use of any product shall be as set forth in Isabellenhütte’s terms and conditions of sale.

