

## Bulk Metal® Foil Technology RNC90Y and RNC90Z (Z-Foil) to MIL-PRF-55182/9

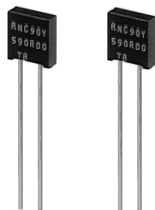

### INTRODUCTION

Military Established Reliability resistors from VPG are available in resistance values from 4.99 Ω through 121 kΩ and with tolerances from ±0.005% to ±1.0%. The same resistors are also available as non-qualified products for customers desiring higher or lower resistance values and the same or better performance capabilities (see Table 2). Both qualified and non-qualified versions are manufactured on the same production line facilities and are subjected to the same process, lot control, conditioning, and GRP A (100%) screening. Qualified versions receive additional MIL Group B and C testing.

The RNC90Y has been the benchmark for high-precision, established-reliability discrete resistors since 1982. In 2000, VFR engineers achieved a technological breakthrough with the introduction of the commercial ultra-precision, low-TCR Z201 resistor. This breakthrough allowed for the introduction of a resistor with very low TCR and an “R” failure rate (FR) level. The RNC90Z tightest TCR limit of ±2 ppm/°C over the extended range of -55°C to +175°C is a significant improvement over the existing RNC90Y specification (see Table 1).

### FEATURES

- QPL resistor with established reliability (ER), qualified to MIL-PRF-55182/9
- “R” level reliability
- Load life stability: ±0.05% ΔR for 2000 h, 0.3 W at +125°C
- Temperature coefficient of resistance (TCR): to ±2 ppm/°C (-55°C to +175°C)
- Resistance tolerance: to ±0.005%
- Thermal EMF: <0.1 μV/°C
- Qualified resistance range: 4.99 Ω to 121 kΩ (RNC90Y)  
4.99 Ω to 121 kΩ (RNC90Z)
- Specially conditioned non-QPL resistors available  
See data sheet “Improved Performance Tested”
- Fast thermal stabilization
- Electrostatic discharge (ESD) above 25,000 V
- Non inductive, non capacitive design
- Current noise < - 42 dB
- Prototype sample available

**FIGURE 1 – COMPARISON OF RNC90Y TO RNC90Z TEMPERATURE COEFFICIENT OF RESISTANCE**

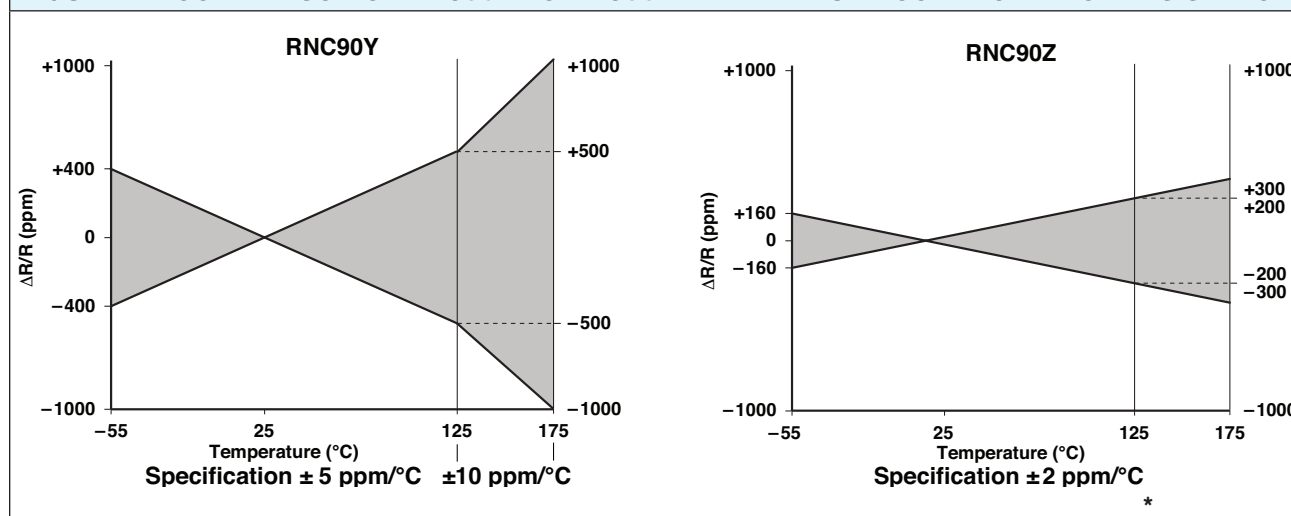

\* Above 30.1 Ω

TABLE 1 – SPECIFICATIONS COMPARISON				
SPECIFICATION	RNC90Y (QUALIFIED) MIL-PRF-55182/9 CHARACTERISTIC Y LIMITS	RNC90Z (QUALIFIED) MIL-PRF-55182/9 CHARACTERISTIC Z LIMITS	S555 (NON-QUALIFIED) VFR PERFORMANCE LIMITS	Z555 (NON-QUALIFIED) VFR PERFORMANCE LIMITS
Temperature Coefficient of Resistance	±5 ppm/°C (-55°C to +125°C) ±10 ppm/°C (+125°C to +175°C)	4.99 Ω to 30.1Ω ±3 ppm/°C (-55°C to +175°C)  30.1 Ω to 121 kΩ ±2 ppm/°C (-55°C to +175°C)	±5 ppm/°C (-55°C to +125°C)	5 Ω to 30Ω ±3 ppm/°C (-55°C to +125°C)  30.1 Ω to 150 kΩ ±2 ppm/°C (-55°C to +125°C)
Resistance Range	4.99 Ω to 121 kΩ	4.99 Ω to 121 kΩ	1 Ω to 150 kΩ	5 Ω to 150 kΩ
Failure Rate	Level R	Level R	Not specified	Not specified
Load-Life Stability 0.3 W at +125°C at 2000 h at 10 000 h	±0.05% maximum ΔR ±0.5% maximum ΔR	±0.05% maximum ΔR ±0.5% maximum ΔR	±0.015% maximum ΔR <sup>(1)</sup> ±0.05% maximum ΔR <sup>(1)</sup>	±0.015% maximum ΔR <sup>(1)</sup> ±0.05% maximum ΔR <sup>(1)</sup>
Current Noise	Not specified	Not specified	-40 dB minimum	-40 dB minimum
High-Frequency Operation Rise Time Inductance <sup>(2)</sup> (L)  Capacitance (C)	Not specified Not specified	Not specified Not specified	1.0 ns at 1 kΩ 0.1 μH maximum 0.08 μH typical 1.0 pF maximum 0.5 pF typical	1.0 ns at 1 kΩ 0.1 μH maximum 0.08 μH typical 1.0 pF maximum 0.5 pF typical
Voltage Coefficient	0.0005%/V	0.0005%/V	0.0005%/V	0.0005%/V
Working Voltage <sup>(3)</sup>	300 V maximum	300 V maximum	300 V maximum	300 V maximum
Thermal EMF <sup>(4)</sup>	Not specified	Not specified	0.1 μV/°C maximum 1 μV/W maximum	0.1 μV/°C maximum 1 μV/W maximum

### Notes

- (1) Load life ΔR Maximum can be reduced by 80% through a screening procedure. Consult our Applications Engineering for details.
- (2) Inductance (L) due mainly to the leads.
- (3) Not to exceed power rating of resistor.
- (4) μV/°C relates to EMF due to lead temperature differences and μV/W due to power applied to the resistor.

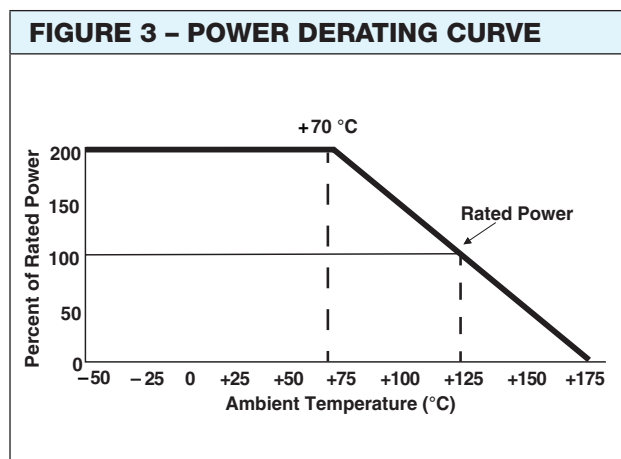
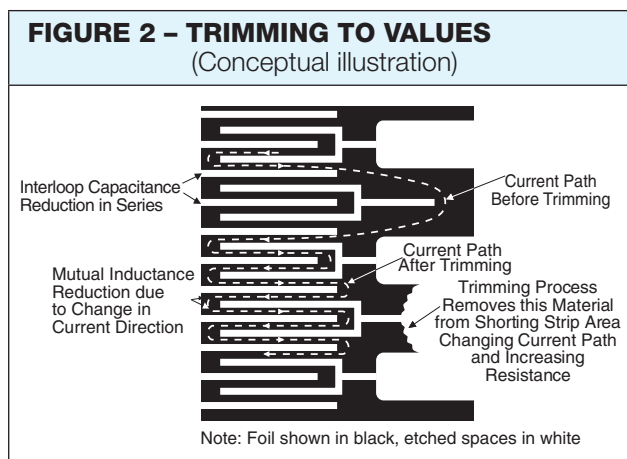

**FIGURE 4 - IMPRINTING AND DIMENSIONS**

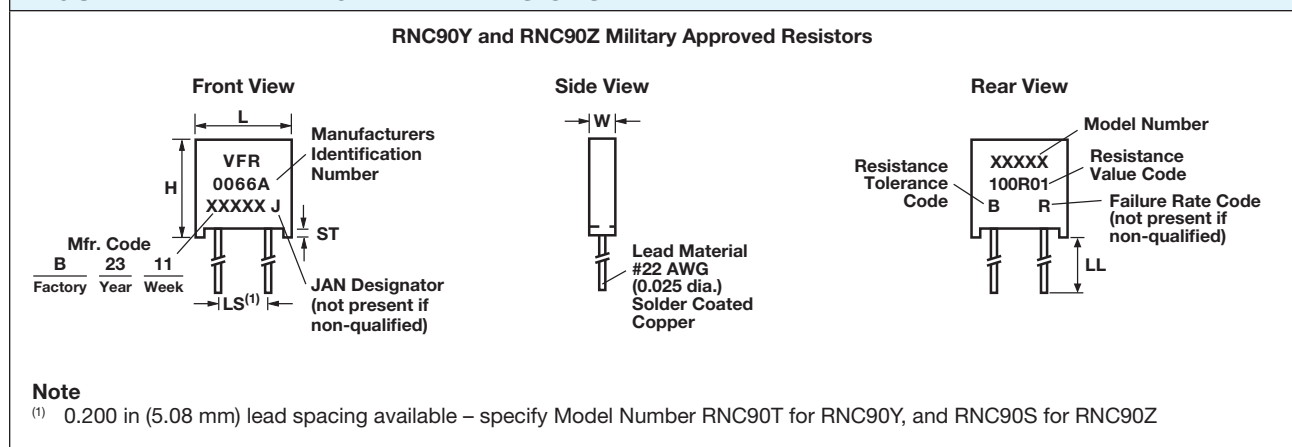

**TABLE 2 - MODEL SELECTION**

MODEL NUMBER	RESISTANCE RANGE ( $\Omega$ )	STANDARD RESISTANCE TOLERANCE		FAILURE RATE	AMBIENT POWER RATING		AVERAGE WEIGHT (g)	DIMENSIONS					
		TIGHTEST %	LOOSEST %		at +70°C	at +125°C		INCHES	mm				
RNC90Y	30.1 to 121K 16.2 to 30.0 4.99 to 16.0	$\pm 0.005$ $\pm 0.05$ $\pm 0.1$	$\pm 1.0$ $\pm 1.0$ $\pm 1.0$	M, P, R (See Table 3)	0.6 W	0.3 W	0.6	W: 0.105 $\pm$ 0.010 L: 0.300 $\pm$ 0.010 H: 0.326 $\pm$ 0.010 ST: 0.010 $\pm$ 0.005 LL: 1.000 $\pm$ 0.125 LS: 0.150 $\pm$ 0.010	2.67 $\pm$ 0.25 7.62 $\pm$ 0.25 8.28 $\pm$ 0.25 0.254 $\pm$ 0.13 25.4 $\pm$ 3.18 3.81 $\pm$ 0.25				
RNC90Z	30.1 to 121K 16.2 to 30.0 4.99 to 16.0	$\pm 0.005$ $\pm 0.05$ $\pm 0.1$	$\pm 1.0$ $\pm 1.0$ $\pm 1.0$		0.6 W	0.3 W				0.6			
S555 (NON QPL)	30.1 to 121K 20 to <30.1 5 to <20 2 to <5 1 to <2	$\pm 0.005$ $\pm 0.01$ $\pm 0.05$ $\pm 0.1$ $\pm 0.5$	$\pm 1.0$ $\pm 1.0$ $\pm 1.0$ $\pm 1.0$ $\pm 1.0$	-	0.6 W	0.3 W	0.6			W: 0.105 $\pm$ 0.010 L: 0.300 $\pm$ 0.010 H: 0.326 $\pm$ 0.010 ST: 0.010 $\pm$ 0.005 LL: 1.000 $\pm$ 0.125 LS: 0.150 $\pm$ 0.010	2.67 $\pm$ 0.25 7.62 $\pm$ 0.25 8.28 $\pm$ 0.25 0.254 $\pm$ 0.13 25.4 $\pm$ 3.18 3.81 $\pm$ 0.25		
	>121K to 150K	$\pm 0.005$	$\pm 1.0$	-	0.4 W	0.2 W						0.6	
Z555 (NON QPL)	30.1 to 121K 20 to <30.1 5 to <20R	$\pm 0.005$ $\pm 0.01$ $\pm 0.05$	$\pm 1.0$ $\pm 1.0$ $\pm 1.0$	-	0.6 W	0.3 W	0.6					W: 0.105 $\pm$ 0.010 L: 0.300 $\pm$ 0.010 H: 0.326 $\pm$ 0.010 ST: 0.010 $\pm$ 0.005 LL: 1.000 $\pm$ 0.125 LS: 0.150 $\pm$ 0.010	2.67 $\pm$ 0.25 7.62 $\pm$ 0.25 8.28 $\pm$ 0.25 0.254 $\pm$ 0.13 25.4 $\pm$ 3.18 3.81 $\pm$ 0.25
	>121K to 150K	$\pm 0.005$	$\pm 1.0$	-	0.4 W	0.2 W							

**Note**

S555 and Z555 units are manufactured on the same production line facilities and are subjected to all the same process and lot control requirements imposed on RNC90Y (Z) version, as well as all of the special screening, environmental conditioning and documentation stipulations outlined in MIL-PRF 55182/9

**TABLE 3 – GLOBAL PART NUMBER INFORMATION**

**NEW GLOBAL PART NUMBER: Y1189100R500AR0L (preferred part number format)**

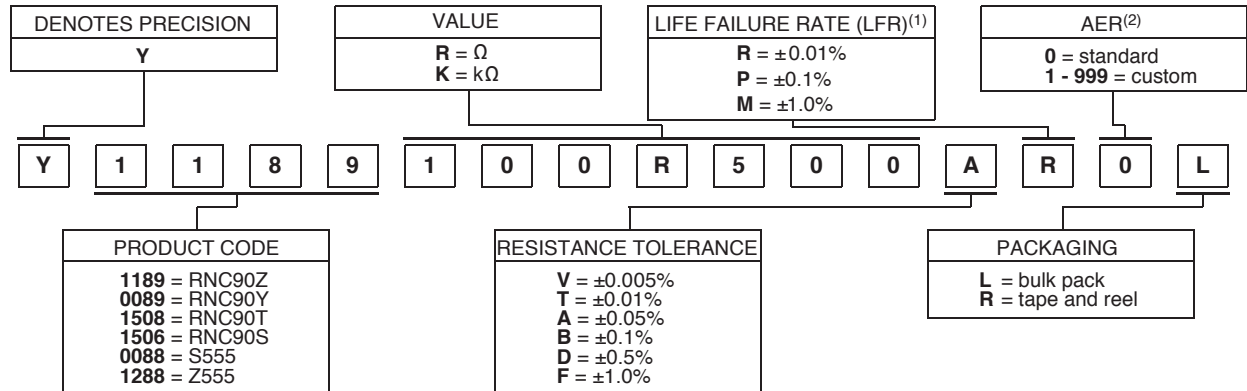

**FOR EXAMPLE: ABOVE GLOBAL ORDER Y1189 100R500 A R 0 L:**

TYPE: RNC90Z  
VALUE: 100.5 Ω  
ABSOLUTE TOLERANCE: ±0.05%  
LIFE FAILURE RATE (LFR): ±0.01%  
AER: standard  
PACKAGING: bulk pack

**HISTORICAL PART NUMBER: RNC90Z 100R50 A R B (will continue to be used)**

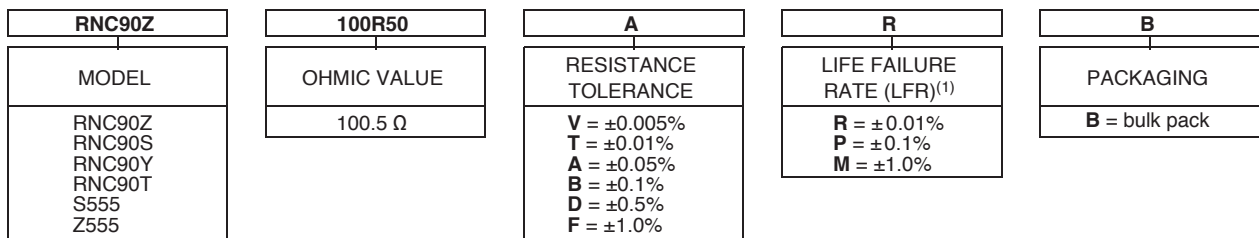

**Notes**

- <sup>(1)</sup> Applicable only for QPL part. For S555 and Z555 please omit the Life Failure Rate designator from the part number and assign “0” instead.
- <sup>(2)</sup> For non-standard requests, please contact application engineering.

**CAGE #0066A**

“Commercial and Government Entity”  
Formerly “FSCM”

The response of military and non military grade resistors to environmental stresses can be made better by “Improved Performance Testing” (IPT). The IPT part will see burn-in and cycling that removes the “knee” from the normal drift of non IPT parts. (See Table 4 for the improvement to expect in military parts when calling for VFR recommended screening). Users should be aware that IPT testing renders the part non QPL and so a 3XXXXX part number will be assigned by VFR. Consult Applications Engineering for details and ordering advice.

**TABLE 4 – IMPROVED PERFORMANCE TESTING (NON-QPL) VS. QPL**

TEST GROUP	TEST	RNC90 MIL-PRF-55182 & MIL-PRF-55182/9		VFR IMPROVED PERFORMANCE TESTING (IPT) LIMITS
		METHOD PARAGRAPH	LIMITS	
I	Burn-in Thermal Shock and Overload Combined	4.8.3.3	±0.05%	±0.0025%
		4.8.2	–	–
		4.8.3	±0.05%	±0.005%
II	Resistance Temperature Characteristic	4.8.9	±5 ppm/°C	±2 ppm/°C (–55°C to +125°C) (Can be sorted for tighter tracking)
	Low Temperature Storage	4.8.23	±0.05%	±0.0025%
	Low Temperature Operation	4.8.10	±0.05%	±0.0025%
	Terminal Strength	4.8.11	±0.02%	±0.005%
III	DWV	4.8.12	±0.02%	±0.001%
	Insulation Resistance	4.8.13	10 <sup>4</sup> MΩ	>10 <sup>4</sup> MΩ
	Resistance to Soldering Heat	4.8.14	±0.02%	±0.01%
	Moisture Resistance	4.8.15	±0.05%	±0.015%
IV	Shock Vibration	4.8.16	±0.01%	±0.0025%
		4.8.17	±0.02%	±0.0025%
V	Load Life at +125°C; 2000 h	4.8.18	±0.05%	±0.005% (50 ppm)
	Load Life at +125°C; 10 000 h	4.8.18	±0.5%	±0.015% (150 ppm)
V (a)	+85°C Power Rating	–	–	±0.005% (50 ppm)
	+70°C Power Rating	4.8.18	±0.05%	±0.005% (50 ppm)
V (b)	+25°C Power Rating	–	–	±0.005% (50 ppm)
VI	Storage Life (1year)	–	–	±0.0025%
VII	High Temperature Exposure	4.8.19	±0.5%	±0.005%
VIII	Max. Allowance Reactance	–	–	<1%
	Current Noise	–	–	<–42 dB
	Voltage Coefficient	4.8.20	0.0005%/V (5 ppm/V)	0.00005%/V (0.5 ppm/V)
	Thermal EMF	–	–	0.1 μV/°C

**FIGURE 5 – IMPRINTING AND DIMENSIONS** in inches (millimeters)

